

# RADIO & Television RETAILING

Including  
**ELECTRICAL  
APPLIANCES**  
Section  
See pp. 61-76

CALDWELL-CLEMENTS, INC. ★ DECEMBER 1945



**WHAT'S AHEAD  
FOR 1946—**

**in Radio, FM,  
Television,  
Refrigerators,  
Records and  
Service**

# Your MALLORY Distributor...

... the right man,  
in the right place,  
with the right help

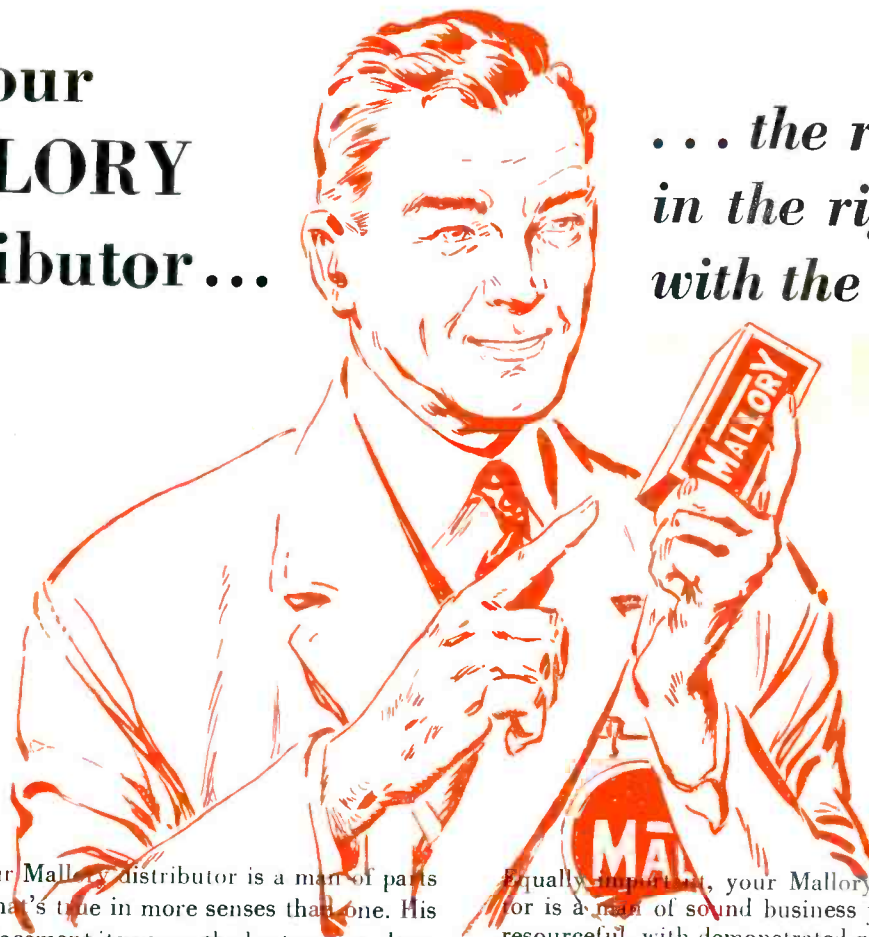

Your Mallory distributor is a man of parts—that's true in more senses than one. His replacement items are the best you can buy. His experience will help you locate them *quickly*—assist you, too, in installing them properly. If a particular item is impossible to get, he'll find you the best possible substitute.

Equally important, your Mallory distributor is a man of sound business judgment, resourceful, with demonstrated qualities of leadership. He'll assist you in problems of sales and management—even help you in training personnel. Your Mallory distributor is a good man to cultivate. He's been especially appointed because of his *capacity* and *willingness* to serve.

## Here's What He'll Do For You:

1

Offer you a complete line of Mallory replacement parts... many of them first developed by Mallory research... ALL of them guaranteed against premature failure by years of service in the field.

2

Meet the maximum number of your application needs with the minimum number of parts. His program of Mallory Standardization will reduce your investment, simplify replacement, speed up delivery.

3

Give you detailed information on prices, parts, catalog numbers... work his head off to get you the items you need when you need them... give you prompt, efficient service *always*.

4

Provide you with bulletins, booklets, catalogs, letters, giving complete data on what to use and where to use it... offer you special publications and new developments and technical service fundamentals.

5

Offer his own personal experience in helping you solve unusual or difficult problems... help you train sales and service personnel... give you the extra help you need to meet emergencies.

6

Provide you, if asked, with sound methods of keeping your business on the beam... give you special promotion materials to help you sell your story to the public.

The Part Your Mallory Distributor Plays Is Important TODAY—to YOU!

P. R. MALLORY & CO., Inc., INDIANAPOLIS 6, INDIANA



More than ever—  
ALWAYS  
INSIST ON

P. R. MALLORY & CO. Inc.  
**MALLORY**  
APPROVED  
PRECISION PRODUCTS

VIBRATORS • VIBRAPACKS\* • CONDENSERS  
VOLUME CONTROLS • SWITCHES • RESISTORS  
FILTERS • RECTIFIERS • POWER SUPPLIES

ALSO MALLORY "TROPICAL"™ DRY BATTERIES, ORIGINALLY DEVELOPED BY MALLORY FOR THE U. S. ARMY SIGNAL CORPS, NOT PRESENTLY AVAILABLE FOR CIVILIAN USE.

\*Reg. U. S. Pat. Off.

# RADIO & Television RETAILING\*

Including Radio and Television Today

Including  
**ELECTRICAL  
APPLIANCES**  
Section

IN THIS ISSUE

DECEMBER, 1945

**ORESTES H. CALDWELL**  
Editor

**M. CLEMENTS**  
Publisher

**JOHN L. STOUTENBURGH**  
Managing Editor

**HELEN THURMAN**  
Associate Editor

**WILLIAM E. MOULIC**  
Technical Editor

**CHARLES F. DREYER**  
Art Director

Assistant Editors

**NATHANIEL J. KERN**

**E. T. BENNETT**

**RUTH MORRIS**

**STEPHEN I. HALL**  
Merchandising Editor

BUSINESS DEPARTMENT

**LEE ROBINSON**  
Sales Manager

**M. H. NEWTON**  
Business Manager

**J. A. SAMBORN**

**G. B. ANDREWS**

**B. V. SPINETTA**  
Circulation Manager

**BEN MORRIS**  
Promotion Manager

**J. COSIN**  
Research

**B. HALL**  
Production

Branch Offices

CHICAGO

**E. Y. FITZPATRICK**  
301 N. Wells St.  
RAN. 9226

CLEVELAND

Citizens Bldg., 860 Euclid Ave.  
MAin 3270

LOS ANGELES

**ROBERT W. WALKER**  
Walker & Minton  
403 W. 8th St.  
VAndika 9848

SAN FRANCISCO

**ELI C. MINTON**  
Walker & Minton  
68 Post St.  
SUtter 5568

## ★ Radio, Television and Records

COVER: What's Ahead for 1946

EDITORIAL—Greater Future Ahead for Independents .....	33
RADIO, ELECTRICAL APPLIANCES, RECORDS, AND TELEVISION TODAY	34
SPOTLIGHT ON 1946 .....	36
MODERN STORE BOOSTS SALES .....	38
CUT NEEDLESS EXPENSE .....	40
SELLING METHODS FOR INCREASING SALES .....	42
PRESENTING THE NEW RADIO SETS .....	44
HIGH PROFITS IN CUSTOM RECORDING .....	50
STORE ARRANGEMENT ATTRACTS SALES .....	52
HOW TO SELECT PERSONNEL FOR DISC SELLING .....	54
LATEST IN RECORD MERCHANDISE .....	56
SERVICE IS ESSENTIAL .....	58
<b>RADIO DIRECTORY</b> .....	<b>60</b>

## ★ Electrical Appliances

COVER: Invite Her Into Your Store

NEW-DAY SALESMANSHIP .....	63
SELL HEALTH AND COMFORT APPLIANCES .....	64
HOW TO SELL MORE ELECTRICAL APPLIANCES .....	66
NEWEST IN ELECTRICAL APPLIANCES .....	70
<b>APPLIANCE DIRECTORY</b> .....	<b>86</b>

## ★ Service and Sound

SPEED UP SET SERVICING .....	78
TECHNICAL NEW PRODUCTS .....	80
SERVICING FILTER CAPACITORS (Part II) .....	88
TIMELY SERVICE HINTS .....	90
SAVE FM FOR LISTENERS .....	92
SERVICING FM AND TELEVISION .....	96
"SOUND" SALES AND MAINTENANCE .....	100
GREAT NEW "HAM" MARKET SEEN .....	104
RADIO SERVICE BRIEFS .....	108
REVIEWING THE NEW BOOKS .....	110
YOUR MARGINS ARE REDUCED .....	114
TELEVISION TALK .....	122
DISTRIBUTOR NEWS .....	128
INDUSTRY NEWS .....	94 to 162



CALDWELL-CLEMENTS, INC.—TEL.: PLAZA 3-1340—480 LEXINGTON AVE., NEW YORK

# HERE THEY

NEW 1946 MODELS FROM

# Admiral

All brand **NEW** 1946 models. **NEW** cabinet beauty and construction, **NEW** dial designs, **NEW** mechanical features.



**6RT43.** Radio-phonograph combination with automatic record changer. Walnut wood cabinet.



**6RT42.** Radio-phonograph with automatic record changer. Attractive walnut wood cabinet.

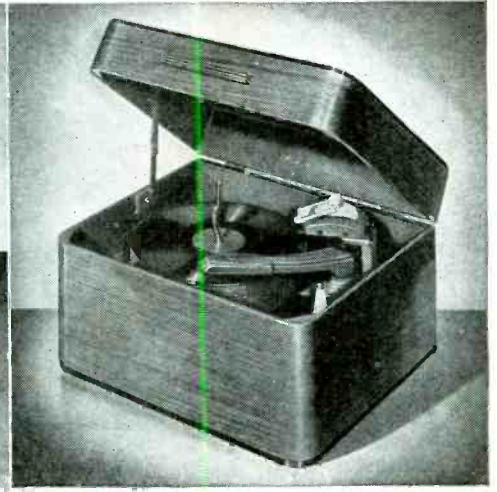

**6RC46.** Automatic record changer. Plays records through any radio. Walnut wood cabinet.



**6T02.** Table-top radio in smartly styled plastic cabinet. Ivory or mahogany finish.



**6T04.** Table-top radio in beautiful walnut wood cabinet. Easy-to-read, "Stretch-out" dial.

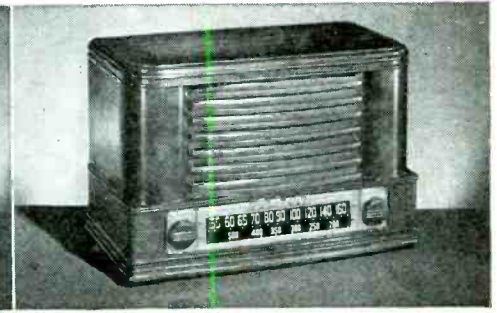

**6T05.** Table-top radio in walnut cabinet... walnut wood at its finest. Slide rule dial.

MAKERS OF ADMIRAL RADIO—  
*America's Smart Set*

## Admiral Corporation

WORLD'S LARGEST MANUFACTURER OF RADIO-PHONOGRAPHS WITH AUTOMATIC RECORD CHANGERS

# ARE!

- **Table-Top Radios**
- **Radio-Phonographs with Automatic Record Changers**  
(table and console)
- **Farm Radio**  
(battery operated)
- **Automatic Record Changers**  
(use with any radio)

**NEW** ideas for customer convenience and enjoyment.

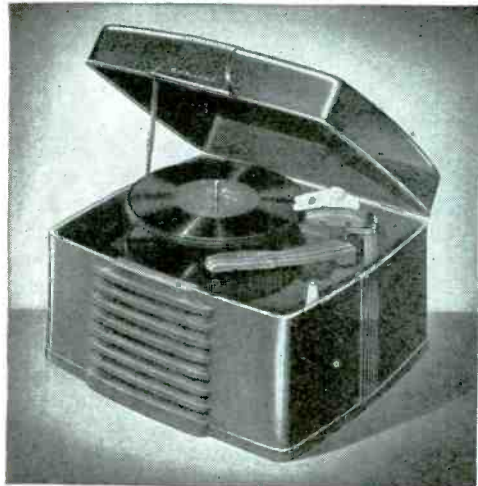
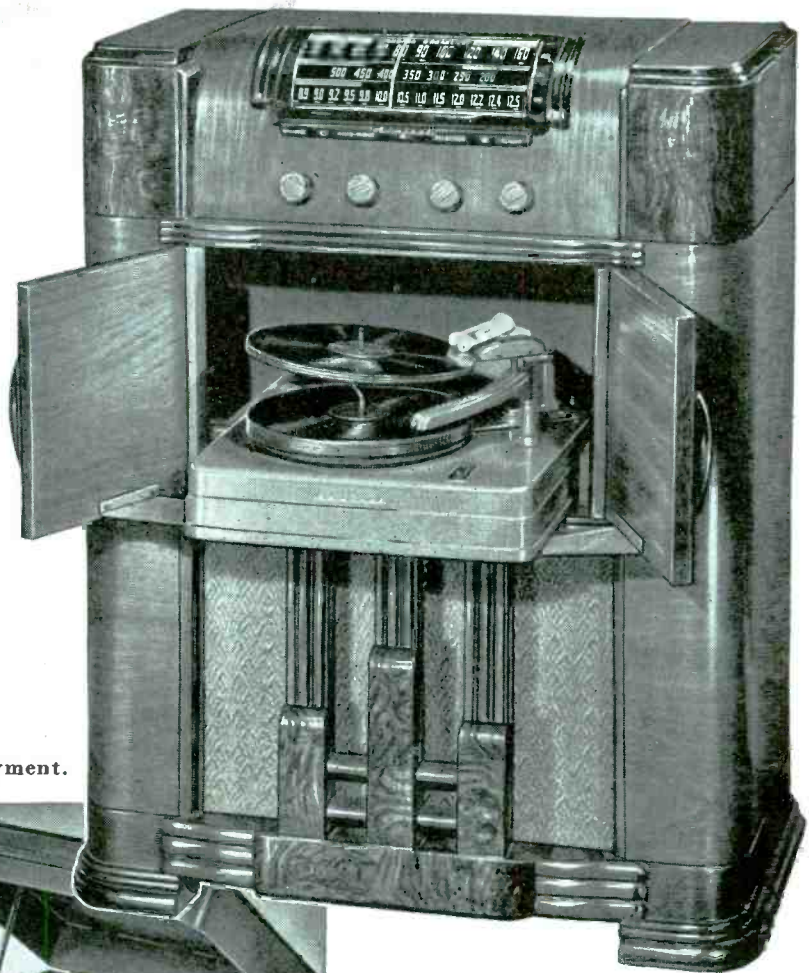

**6RP48.** Electric Phonograph with automatic record changer. Ivory or mahogany plastic.



**6RP49.** Electric Phonograph with automatic record changer. Beautiful walnut wood cabinet.



**6T01.** Table-top radio in streamlined ivory or mahogany plastic cabinet. Slide rule dial.



**6T06.** Battery operated farm radio in walnut wood cabinet. Easy-to-read, "Stretch-out" dial.

**6C62.** Radio-phonograph console with "Slide-a-Way" automatic record changer. Beautiful walnut wood cabinet.



**RC-1.** Record Album Cabinet of beautiful walnut wood. Provides convenient Record Changer stand, handy storage space for ninety-six 12-inch records in albums.

**5RP47.** Automatic record changer... plays records through any radio.



**Admiral Tubes.** Most types now available. Guaranteed for excellence and high fidelity performance. Get your share of the huge radio tube replacement business.

**Ensign Radio Batteries**—Perfect for replacements in all types of battery-operated portable and farm radios. Every battery guaranteed for long life and excellence in workmanship.



**N-1. Lifetime Precious Jewel Needle** in lucite case. Individually packaged. Genuine sapphire point. Plays up to 10,000 records without changing.



## CHICAGO 47, ILLINOIS

DUAL-TEMP REFRIGERATORS... HOME FREEZERS... ELECTRIC RANGES

The advertisement features a large circular logo at the top left with the word "MERIT" in an arc at the top, "CVC" in the center, and "Since 1924" and "FINE RADIO PARTS" below. Below the logo is a photograph of a product box for "Merit TRANSFORMERS POWER AUDIO CHOKES". The box is a trapezoidal prism with the Merit logo and "A PRODUCT OF" printed on its sides. At the bottom of the box, it reads "MERIT COIL & TRANSFORMER CORP. 4427 NORTH CLARK STREET - CHICAGO 40, ILL.". Below the box is a photograph of a long, single-story industrial building with a tree in the foreground.

**MERIT COIL & TRANSFORMER CORP.**

4427 North Clark St. Telephone Long Beach 6311 CHICAGO 40, ILL.

### **A Statement on New Advertising Rates**

As the result of accelerating printing costs induced by labor demands, the advertising rates of Caldwell-Clements, Inc., publications—RADIO & Television RETAILING and ELECTRONIC INDUSTRIES—are being raised, effective with the February issues.

In four war years, from December 1941 until the present, these printing costs alone have increased the staggering amount of 66.5%. This is RADIO & Television RETAILING'S first rate rise in twenty years.

As a result of demands made upon New York printers by the International Typographical Union, we have now been presented with the latest in this series of accelerating expenses, amounting to 28%—retroactive to November 1st. As far as we know, never before has such action been taken on this basis.

In October the circulation of both magazines was increased—RADIO & Television RETAILING to 27,000 and ELECTRONIC INDUSTRIES to 18,293. After investigating all additional costs occurring in normal operations, our printer agreed that a 6% increase would sufficiently cover us for some time ahead. With that, and greater efficiency, we decided to absorb this increase as we had all others. The extra circulation was to be a bonus to our advertisers.

This November 28% rise in printing has to be added to all of the increases we had already absorbed over the four year period. Here are some other factors at work: engraving costs have risen 70%, paper 25%, personnel 30%.

The chief beneficiaries of the ever-expanding RADIO & Television RETAILING have been our readers, who now total 27,000. All the while our subscription rates have remained low in relation to cost and actual worth; dealers have now a magazine larger than pre-war, the largest staff, the finest trade magazine in twenty years.

That is why we have continued to remain the dealers' choice for two decades. With a magazine completely dedicated to better serving the independent radio-electrical dealers of America, we will continue to produce the best magazine that can be published, chaotic conditions notwithstanding. Our future is directly linked with yours.

**M. Clements**

*Publisher*

# Wherever the GAROD LINE is shown...

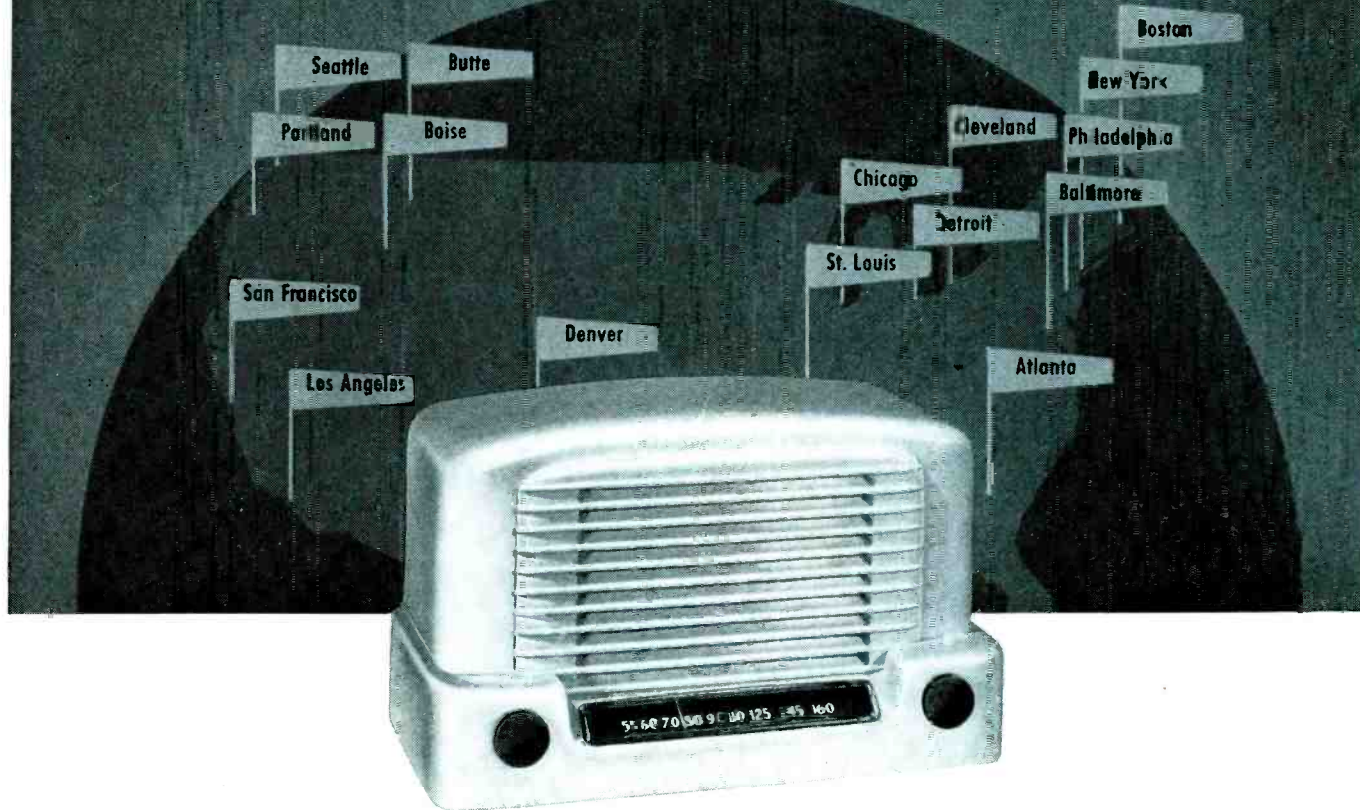

**dealers say, "this is it, boys!"**

Not until you've seen what dealers in these cities have seen will you appreciate the magnetism of the Garod Line. And this isn't something the advertising man dreamed up. He's been at all the "Shows", talked to the dealers, heard them talk among themselves, and seen names being signed to franchise agreements. The Garod Line will be shown in your territory soon... contact your local Garod distributor now.

**GAROD**  **RADIO**

GAROD RADIO CORPORATION • 70 WASHINGTON STREET • BROOKLYN 1, N. Y.





*"You take it and like it"*

...from a

**PRESTO RECORDING!"**

"We have each of our programs transcribed on Presto equipment because it's easy to take criticism from a Presto Recording," says lovely Evelyn Knight, singing star of CBS' "Powder Box Theatre". "When you specialize in tricky rhythms as I do, it's important to be able to play back the show to review your work."

Broadcasting stations and recording studios use Presto equipment because they can depend on Presto to produce high quality work. Schools and business organizations, too, prefer Presto because a Presto Recorder can take hard usage and is simple to operate. Write for complete information.



**PRESTO**

**RECORDING CORPORATION**  
242 West 55th Street, New York 19, N. Y.  
Walter P. Downs, Ltd., in Canada



**WORLD'S LARGEST MANUFACTURER OF INSTANTANEOUS SOUND RECORDING EQUIPMENT AND DISCS**



# KEN-RAD

## CATHODE-RAY TUBES

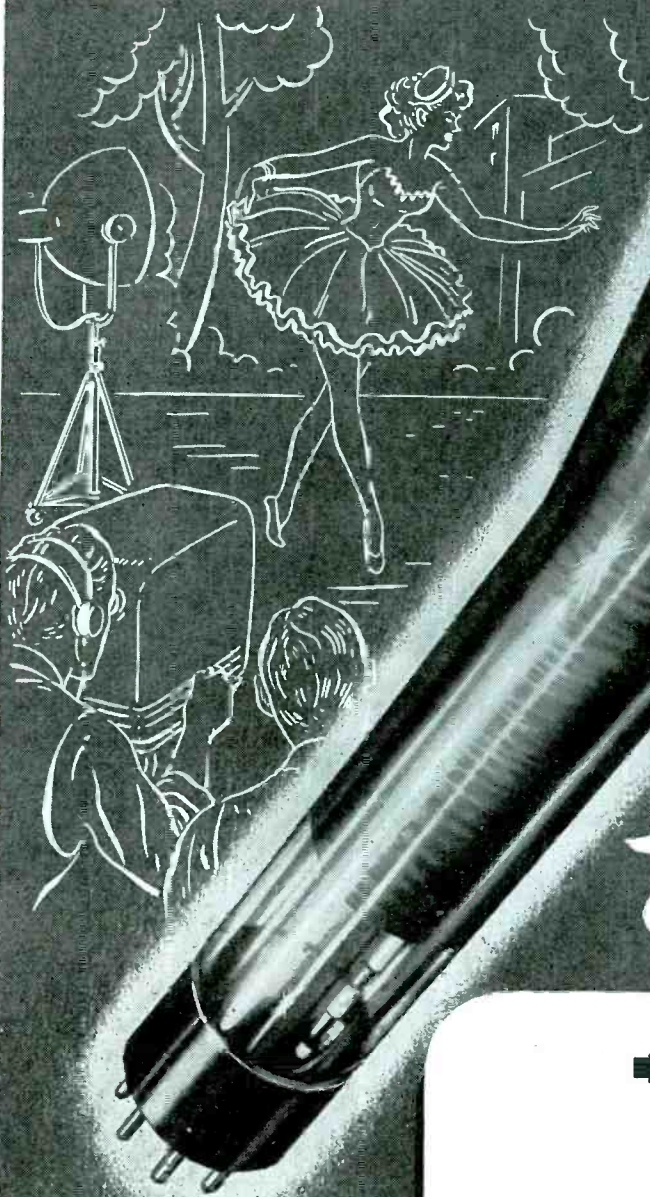

*Better  
than ever*

➔ Our great new age of television will owe much to the picture-sharpness and realism offered by Ken-Rad Cathode-Ray Tubes . . . Added facilities for research, testing, and production promise still finer tube performance . . . Tomorrow's big market for Ken-Rad television tubes is but *one of many* profit opportunities for Ken-Rad dealers.

✉ Write for your copy of  
"Essential Characteristics"  
the most complete digest of  
tube information available.

178-D15-6850

# KEN-RAD

DIVISION OF GENERAL ELECTRIC COMPANY

OWENSBORO, KENTUCKY

DEALERS EVERYWHERE ACCLAIM

# Bendix Radio



## THE REAL "DEALER-PLANNED" RADIO LINE!

Bendix planned it that way! Planned to give its dealers a line of radios easy to sell—easy to demonstrate—with salable features in every model, plus sparkling new beauty of design that is truly outstanding. And, too, Bendix backs its dealer organization with one of the largest national magazine and newspaper campaigns in the industry . . . backs them with local newspapers, outdoor identification signs, displays and sales promotion plans. Bendix, too, has for its dealers a complete

visual sales training program with everything needed to assist dealers in building a highly successful sales force. Contact your Bendix Radio Distributor now, or write direct to Bendix Radio Division, Baltimore 4, Maryland.

BE SURE TO SEE THE BENDIX RADIO EXHIBIT  
at the Home Furnishings Market space 69-70 on the  
17th floor Furniture Mart, Chicago—January 7 to 19th.

**BUILD BEST WITH BENDIX . . . FOR PRESTIGE . . . PROFITS . . . PERMANENCE!**



# ULTRATONE

♪ THE COMPLETE PHONOGRAPH LINE ♪

A PARTIAL LIST OF

## ★ ★ ★ DISTRIBUTORS ★ ★ ★

Kansas City, Missouri  
Superior Distributing Co.  
2307 Pennway

Indianapolis, Indiana  
Appliance Distributors, Inc.  
421 East Market Street

Tampa, Florida  
Gulf Appliance Distributors, Inc.  
206 South Franklin Street

Norfolk, Virginia  
Bowers Wholesale Corporation  
1605 Granby Street

Albany, New York  
Empire State Distributors  
10 Hudson Avenue

Cleveland, Ohio  
Grossman Music Company  
210 Prospect Avenue

Chicago, Illinois  
General Utilities Distributors, Inc.  
540 North Lake Shore Drive

Milwaukee, Wisconsin  
General Utilities Corp.  
647 West Virginia Street

Philadelphia, Pennsylvania  
H. & S. Distributing Company  
812 North Broad Street

Baltimore, Maryland  
Henry O. Berman Company  
12 East Lombard Street

Rochester, New York  
Harmon Automotive Corp.  
16 Charlotte Street

Pittsburgh, Pennsylvania  
I. & M. Sufrin  
1207 Muriel Street

Buffalo, New York  
H. D. Taylor Company  
99 to 117 Oak Street

New York, New York  
Gross Distributors, Inc.  
570 Lexington Avenue

Boston, Massachusetts  
E. Stanley Freeman, Inc.  
80 Federal Street

Providence, Rhode Island  
Republic Distributing Co.  
159 Orange Street



Model TA-6

Automatic Record Player  
3-Tube Amplifier

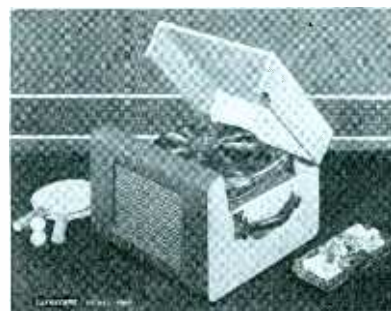

Model PA-6

Portable Automatic  
Record Changer

NO RADIOS—PHONOGRAPHS EXCLUSIVELY  
*Contact Your Distributor—or Write Direct*

*Audio* INDUSTRIES

MANUFACTURERS OF ULTRATONE PHONOGRAPHS · MICHIGAN CITY, IND. U. S. A.



# A New Jensen Coaxial

## TYPE H

### WITH *Compression-type* HIGH-FREQUENCY SPEAKER

The first of a new series of JENSEN Coaxial Speakers, combining in one coaxial assembly a horn-type high-frequency speaker with a cone-type low-frequency unit. By unique design, the cone of the low-frequency unit forms a part of the high-frequency horn, thereby dispensing with a separate horn. An integral two-channel network gives the desired crossover characteristics. Thus this new Coaxial Speaker provides the quality of reproduction so essential and desirable for radio receivers and phonographs for home entertainment, particularly for FM reception and high quality phonograph recordings.

The distribution characteristics of the Type H Coaxial are excellent and, when installed in a suitable enclosure such as a Bass Reflex cabinet, its performance covers the entire frequency range useful in home reproduction.\*

Type H Coaxial, illustrated here with field coil low-frequency speaker and *ALNICO 5* high-frequency unit, is designed for manufacturers. Other models for more general use, incorporating *ALNICO 5* design in both high-frequency and low-frequency units, will shortly be announced.

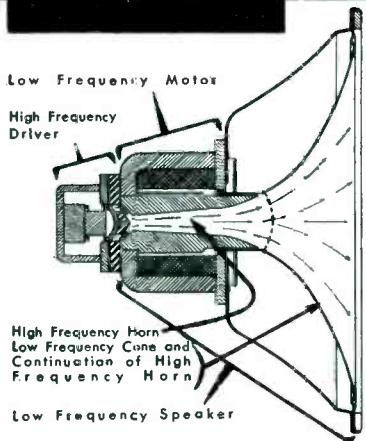
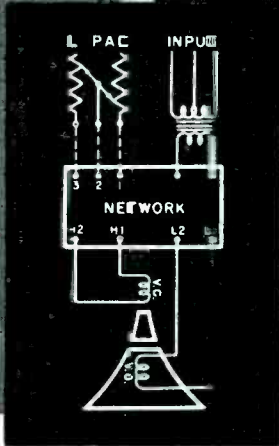

### TYPE H SPECIFICATIONS

Power rating 25 watts maximum, in speech and music systems. Input impedance 16 ohms. Field 14-20 watts. List price approximately \$100.00.

\*See No. 3 JENSEN Monograph: "Frequency Range in Music Reproduction," for discussion of useful frequency ranges.

### Other Coaxials Now Available!



These Type J Coaxials, improved over prewar design, offer low-cost Coaxial performance in home radio receiver and phonograph entertainment.

JAP-60 (15-inch) with HF Control Switch. List price \$79.45

JHP-52 (15-inch) with HF Control Switch. List price \$36.15

JCP-40 (12-inch) HF Level Control extra. List price \$33.45



# Jensen

SPEAKERS WITH

# ALNICO 5

JENSEN RADIO MANUFACTURING COMPANY • 6625 S. LARAMIE AVE. • CHICAGO 38, ILLINOIS  
IN CANADA—COPPER WIRE PRODUCTS, LTD. • 137 OXFORD STREET, GUELPH, ONTARIO

*Specialists in Design and Manufacture of Fine Acoustic Equipment*

# The New Model CA-11 SIGNAL TRACER

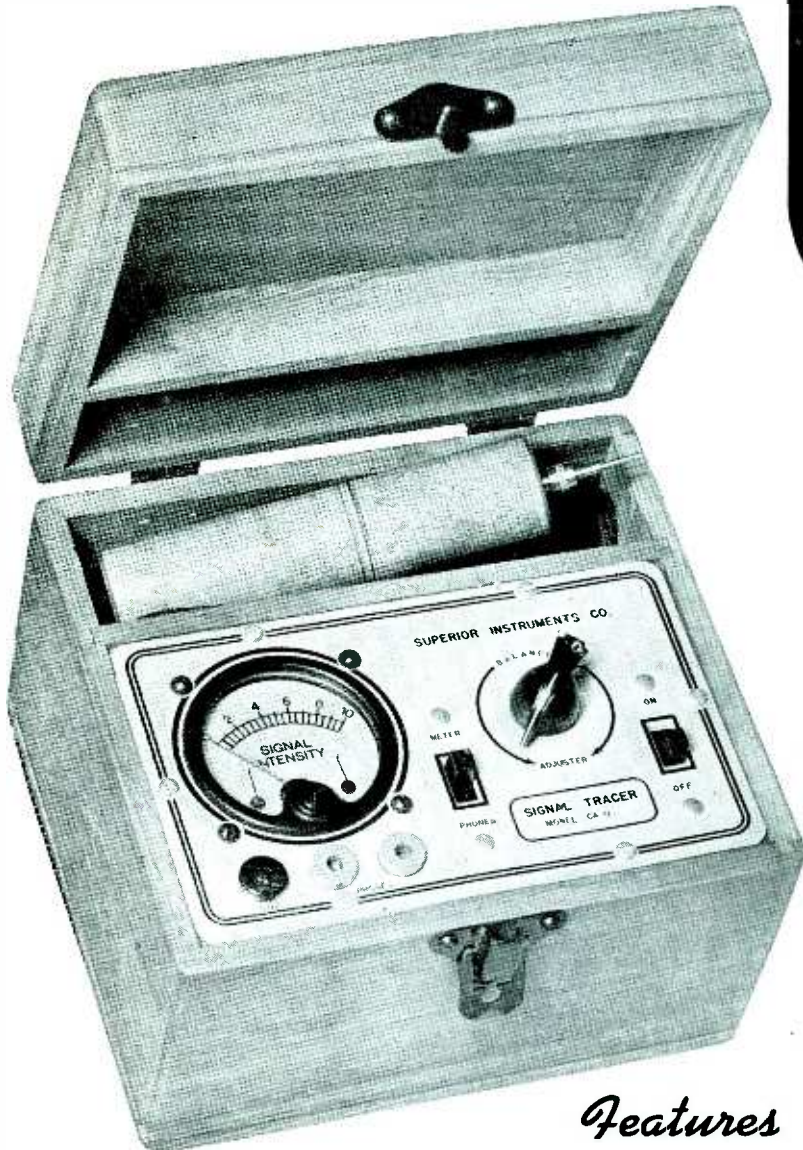

**Simple to operate  
... because it has only  
ONE connecting cable-  
NO tuning controls!**

INTRODUCED in 1939-1940 Signal Tracing, the "short-cut" method of Radio Servicing quickly became established as the accepted method of localizing the cause of trouble in defective radio receivers. Most of the pre-war testers (including ours) were bulky requiring a number of connections before the unit was "set for operation" and included a tuned amplifier which had to be "retuned" to compensate for signal shift.

The new model CA-11 affords all the advantages offered by the pre-war models and only weighs 5 lbs., and measures 5"x6"x7".

Always ready for immediate use without the necessity of connecting cables, this amazingly versatile unit has NO TUNING CONTROLS.

Essentially "Signal Tracing" means following the signal in a radio receiver and using the signal itself as a basis of measurement and as a means of locating the cause of trouble. In the CA-11 the Detector Probe is used to follow the signal from the antenna to the speaker—with relative signal intensity readings available on the scale of the meter which is calibrated to permit constant comparison of signal intensity as the probe is moved to follow the signal through the various stages.

## Features

- ★ SIMPLE TO OPERATE—only 1 connecting cable—NO TUNING CONTROLS.
- ★ HIGHLY SENSITIVE—uses an improved Vacuum Tube Voltmeter circuit.
- ★ Tube and resistor-capacity network are built into the Detector Probe.
- ★ COMPLETELY PORTABLE—weighs 5 lbs., and measures 5"x6"x7".
- ★ Comparative Signal intensity readings are indicated directly on the meter as the Detector Probe is moved to follow the Signal from Antenna to Speaker.
- ★ Provision is made for insertion of phones.

Please place your order with your regular radio parts jobber. If your local jobber cannot supply you kindly write for a list of jobbers in your state who do distribute our instruments or send your order directly to us.

The Model CA-11 comes housed in a beautiful hand-rubbed wooden cabinet. Complete with Probe, test leads and instructions.

NET PRICE

**\$18.75**



## SUPERIOR INSTRUMENTS CO.

DEPT. RT—227 FULTON STREET

NEW YORK 7, NEW YORK

## Be patient—just a trifle longer!



THE NEW Sparton Radios and Radio-Phonographs will be moving your way—shortly.\*

*A lot of them!*

Consoles and table models that offer finer domestic reception and more powerful short wave! Automatic Combinations that insure better reproduction of records and the latest in FM!

All have great depth and brilliancy of tone—and all are superbly styled!

But—remember—all Sparton Radios are sold under the SCMP (Sparton Cooperative Merchandising Plan) to one dealer in each community.

If you are interested in being the exclusive Sparton dealer in your community and in receiving shipments on a direct factory-to-dealer basis, write—Ed Bonia, Sales Manager, The Sparks-Withington Company, Jackson, Mich.

\*Our Radio Plant has been ready to start production since V-J Day. Our inability to deliver immediately is due chiefly to the parts-price controversy.

THE SPARKS-WITHINGTON CO., JACKSON, MICH.

# SPARTON

RADIO'S RICHEST VOICE SINCE 1926



... now, in a striking new package for profitable service business

Key to the powerful N. U. merchandising plans that are now ready to go to work for service dealers—is the most striking package design in the radio parts field.

In this smart, modern, stream-line container, all N. U. branded products will be packaged—adding tremendously to their shelf-display and eye-appeal.

You can count on it—nothing has been left

undone to make the National Union family of products the most profitable of all for the service dealer. In engineering, in product performance, in sales policy, and in merchandising—the N. U. line is in a class by itself in meeting today's needs of the Service Dealer and Parts Distributor.

NATIONAL UNION RADIO CORPORATION  
NEWARK 2, NEW JERSEY

**NATIONAL UNION  
RADIO TUBES AND PARTS**

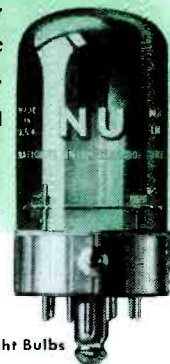

Transmitting, Cathode Ray, Receiving, Special Purpose Tubes • Condensers • Volume Controls • Photo Electric Cells • Panel Lamps • Flashlight Bulbs

# SYLVANIA NEWS

## RADIO RETAILER EDITION

DEC.

Published by SYLVANIA ELECTRIC PRODUCTS INC., Emporium, Pa.

1945

# RETAILERS GAIN CUSTOMER GOOD WILL FROM SYLVANIA NATIONAL SERVICE AD

## Boost for Service Department Helps Build Your Sales

The ad shown at the right appears December 8th in The Saturday Evening Post, reminding countless American radio owners of your part in keeping their old sets working when there were no new ones for sale.

Now that new sets are being made again, you will find your radio repair work even more important. For besides being a highly profitable business in itself, an efficient radio service department will be your most valuable lead for sales of new sets.

### HOW SYLVANIA HELPS YOU

The Sylvania national service ad is gaining recognition for your expert repair work during the war, when skilled men and materials were scarce. It is reminding your customers of the confidence they have in your work—building good-will for your entire business.

This and other Sylvania ads will mean bigger profits for you in another way. You will find more and more of your customers asking for Sylvania tubes in their radios. The superiority of Sylvania Lock-In Tubes for all types of sets has received nation-wide publicity. Other Sylvania tubes have become famous during the war. Handling Sylvania tubes will mean bigger profit opportunities for you.

Let us thank... the Radio Serviceman ... for a job well done!

Despite lack of radio parts and materials... his skill and experience... have kept millions of radios going strong!

Now that the war's over... he's more than ever AT YOUR SERVICE... and he has available SYLVANIA RADIO TUBES.

# SYLVANIA ELECTRIC

Sylvania Electric Products Inc., Executive Office, 200 Fifth Ave., New York 10, N. Y.  
Makers of Radio Tubes; Fluorescent Lamps; Fixtures; Wiring Devices; Electric Light Bulbs; Electronic Devices.

# SYLVANIA ELECTRIC

Emporium, Pa.

MAKERS OF RADIO TUBES; CATHODE RAY TUBES; ELECTRONIC DEVICES; FLUORESCENT LAMPS, FIXTURES, WIRING DEVICES; ELECTRIC LIGHT BULBS



YOUR PHILCO DEALER CAN TELL YOU NOW—



# What's new in Radio from Philco, the Leader!

Yes, your Philco dealer has the full story now... and it's sensational! Philco returns to its unbroken record of radio leadership ten years ahead of four years ago! Again, from the laboratories of the leader come the newest and greatest radio and phonograph developments... electronic achievements that bring you a thrilling advance in the enjoyment of radio and recorded music, in tone, performance and beauty. Visit your Philco dealer today... he's ready to tell you and show you the great and exciting news!

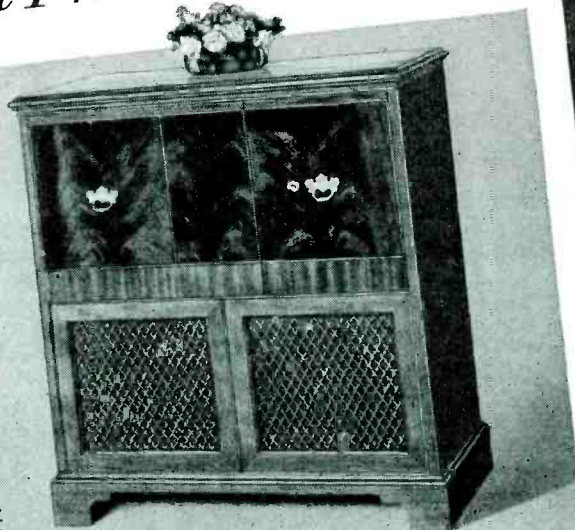

## Sensational Radio Phonograph Developments

New Philco Dynamic Reproducer... New Philco Automatic Record Changer... New Philco Advanced FM System... New Philco Automatic Record Player... exquisite new cabinet designs... yes, new heights of radio-phonograph enjoyment.

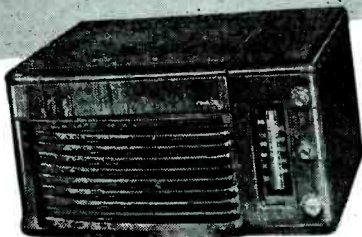

## Automatic Table Model Phonographs

Table radio-phonographs with Automatic Record Changer... brand new in design and convenience. Even the single record radio-phonograph is now automatic, thanks to an amazing Philco invention.



## Greatest Performing Portables Ever Built

By actual test, the greatest performance ever achieved in a portable radio, even in the most difficult locations. Plays anywhere, indoors or outdoors, on any house current or self-contained battery. It's a sensation!

## Exquisite Table Model Radios

A complete selection of compact and table model radios, exquisite in design, using modern plastic and new wood effects. Every one a tremendous value for the price in superb tone, powerful performance and modern cabinet beauty.



# PHILCO

*Famous for Quality  
the World Over*

TUNE IN! The Radio Hall of Fame, Sundays, 6 P.M., EST; Don McNeill and the Breakfast Club, Monday through Friday, 9:45 A.M., EST; ABC (Blue) Network.

## NOW...YOUR CUSTOMERS GET THE NEWS!

This is the first public announcement of the great new radio and phonograph developments from Philco the leader... appearing now in leading magazines. This is the news your customers have

been waiting for... marking Philco's return to overwhelming radio leadership... and making your store headquarters for the biggest radio and phonograph sensations of 1946!



*A picture in Brief of the New*  
**MALLORY**  
**TUBULAR CAPACITORS**

**T**HIS picture is only *part* of a family portrait. It introduces three of a series of new tubular capacitors, stunted in size but long on performance.

Actually, the average capacitor in this new line measures less than the average cardboard type. But each is contained in an aluminum case. **AND** each is hermetically sealed. That means

double protection against moisture absorption and loss of electrolyte!

Single capacity units, common negative duals, separate section duals — you'll find them all among these diminutive newcomers.

Here are the successors to the "Universals" and the "Specials" — *quality* replacements, ideal for close quarters. See your Mallory distributor.

P. R. MALLORY & CO., Inc., INDIANAPOLIS 6, INDIANA



*More than ever—  
 ALWAYS  
 INSIST ON*

P. R. MALLORY & CO. Inc.  
**MALLORY**  
 APPROVED  
 PRECISION PRODUCTS

VIBRATORS • VIBRAPACKS\* • CONDENSERS  
 VOLUME CONTROLS • SWITCHES • RESISTORS  
 FILTERS • RECTIFIERS • POWER SUPPLIES

ALSO MALLORY "TROPICAL" DRY BATTERIES, ORIGINALLY DEVELOPED BY MALLORY FOR THE U. S. ARMY SIGNAL CORPS, NOT PRESENTLY AVAILABLE FOR CIVILIAN USE.

FIG. 1 • (1) • (2)

# *They'll Have Everything...*

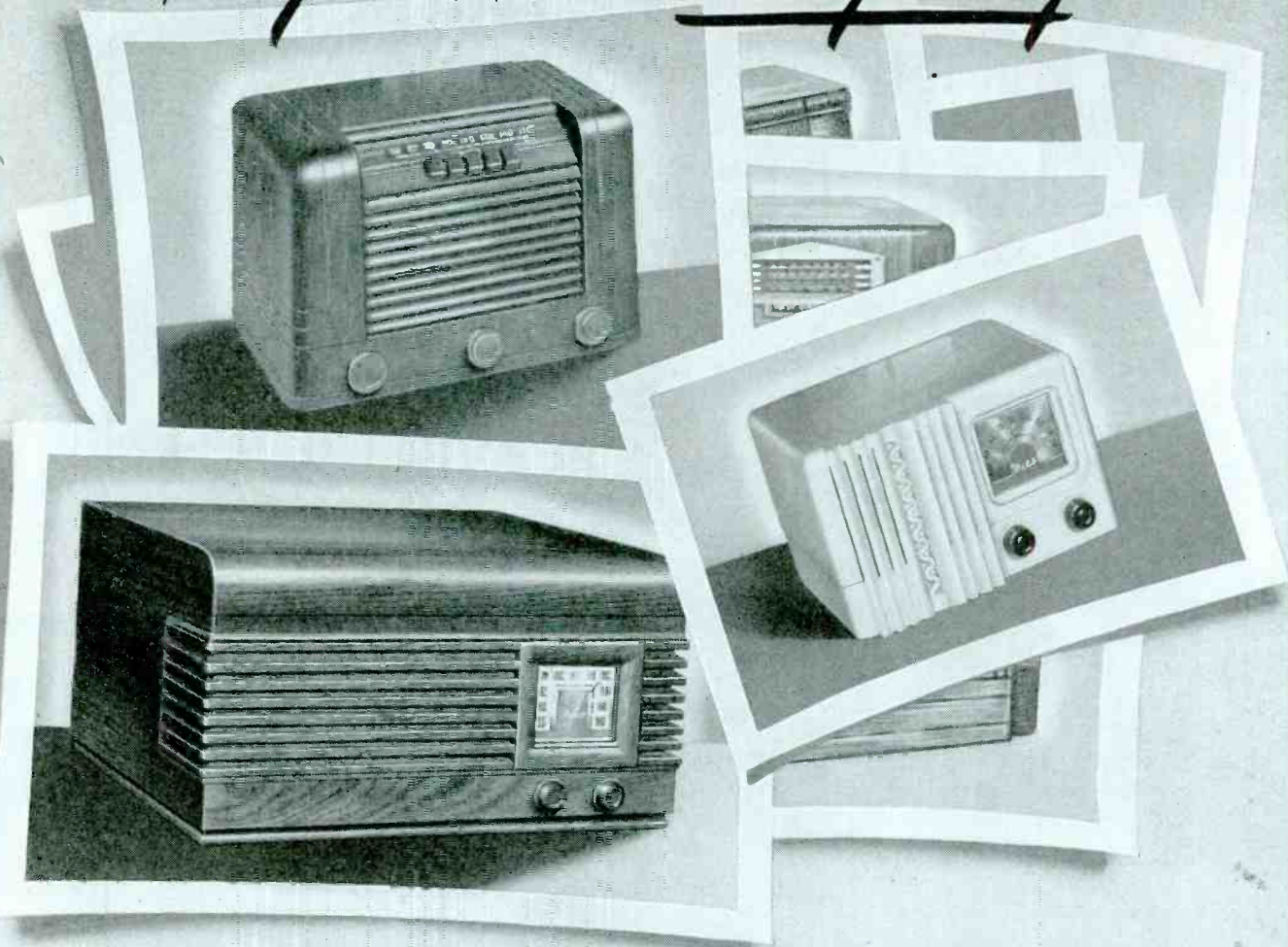

## The best of all that's new in radio

Delco home radios will be in production soon . . . table models, consoles and portables . . . in FM and AM combinations and with standard broadcast bands. They'll provide the best of all that's new in radio . . . sets that set the pace in styling and performance . . . a line that covers the entire range of customer demand. For engineering vision and manufacturing precision . . . backed by long experience in producing Delco auto radios and Delco home radios . . . intensified by wartime accomplishments in building military radios and electronic equipment . . . look to Delco Radio!

ENGINEERING VISION—  MANUFACTURING PRECISION

*They Finished Their Job—Let's Finish Ours*  
BUY VICTORY BONDS

DELCO RADIO  A UNITED MOTORS LINE

**Delco Radio**  
DIVISION OF  
**GENERAL MOTORS**

# PRECISION is a hobby in MT. CARMEL, ILL.

Yes, precision is the hobby of the men and women who make up Meissner's famed "*precision-el*." The high quality electronic equipment that their skilled fingers produce each day is proof enough that they enjoy the work as thoroughly as they enjoy their after-hours hobbies. You'll find more proof in the photographs on this page.



This "*precisioneer*" takes the same interest in his work at Meissner as he does in his home. He proves it with a smile that is typical of *precision-el*—as typical as the precision quality of Meissner products.



Here's a member of Meissner's *precision-el* whose smile is contagious. Delicate adjustments properly made are the reason. Higher quality in Meissner electronic equipment is the result!



It could be a new grandson or a 3-pound bass that brings a smile like this, but it's not! It's pride in a precision electronic job well done. It's a reason for higher quality in Meissner products.



Baseball broadcast? Not on your life. But it's a "homer" for this member of Meissner's laboratory staff. The satisfied smile means that the instrument he's testing is "on the Meissner quality beam."

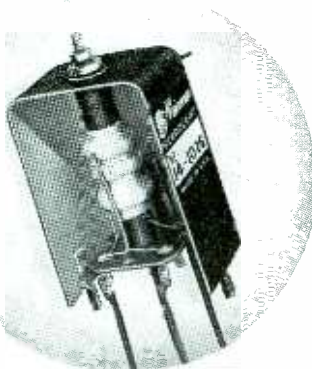

#### Replace Broadcast Band Coils Easily

These Adjustable-Inductance Ferrocart (iron core) coils will replace Antenna, RF or Oscillator coils without the trouble of locating "exact duplicates" because they are continuously variable in inductance over a wide range. The inductance of the old coil is easily matched by simple screwdriver adjustment. Ferrocart iron cores add gain and selectivity to the receiver. Available shielded or unshielded, shipped with complete instructions. Order by number. 14-1026 Univ. Ant. Coil; 14-1027 Univ. R.F. Coil; 14-1028 Univ. Osc. Coil. Price \$1.50 each.



# MEISSNER

MANUFACTURING COMPANY • MT. CARMEL, ILL.

ADVANCED ELECTRONIC RESEARCH AND MANUFACTURE  
Export Division: 25 Warren St., New York; Cable: Simontrice

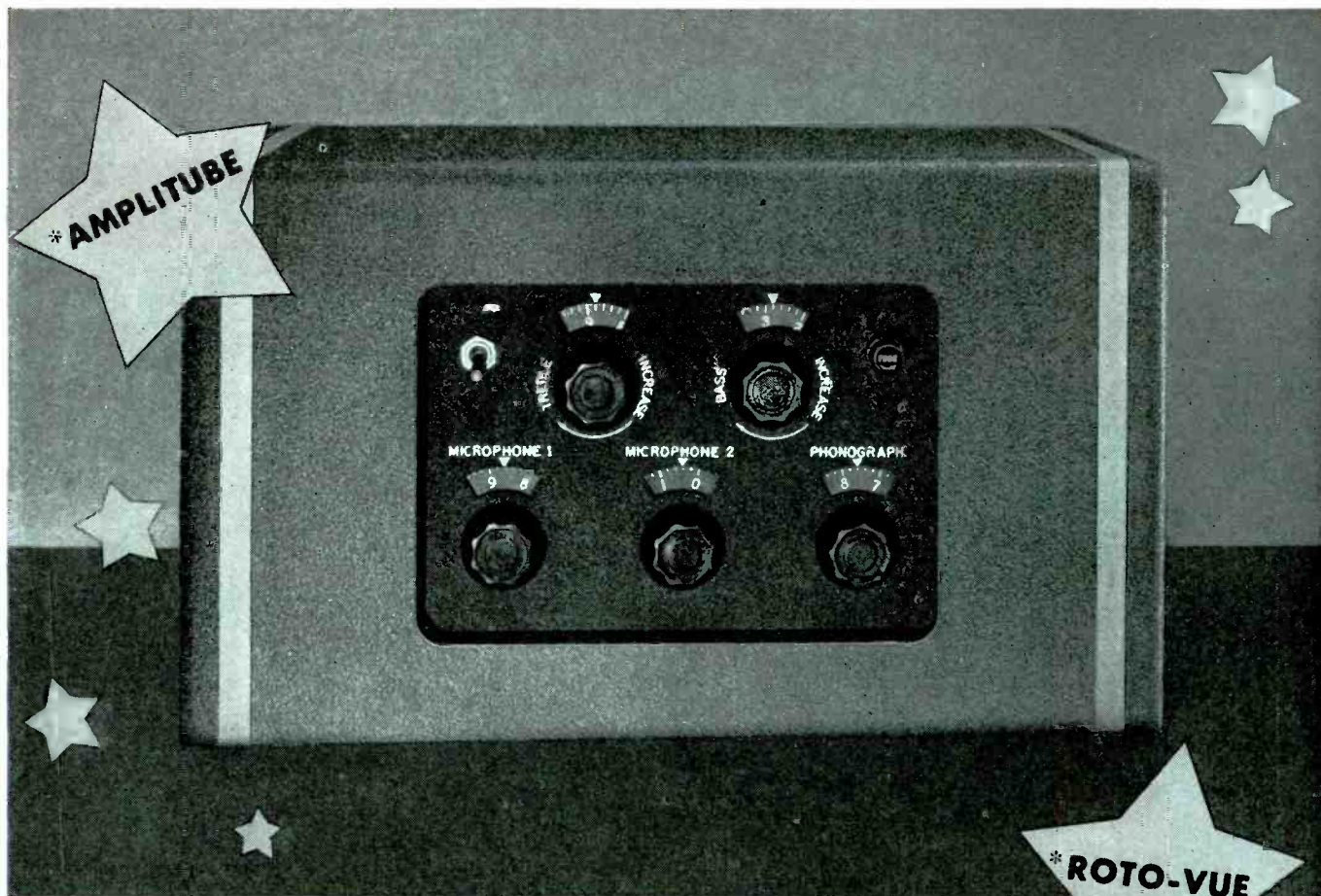

*Ethical Engineering* is the Basis of ★  
 Eastern's 21 STAR FEATURES

\*UNICABLE



Ethical engineering at Eastern is the history of many years in the service of sound amplification. The 21 Star Features are the result of intensive experience dating back to the early days of radio—the pioneer 20s! Today this engineering background accounts for the many innovations we have designed for the new 1946 Eastern Amplifiers—the 21 Star Features that produce Eastern's

famous *Quality Performance*. No other amplifiers, regardless of price, incorporate so many novel and useful features. . . . For complete information and price list—for the first edition of our 1946 Catalog—write today! . . . Eastern Amplifier Corporation, 794 East 140th Street, New York 54, N. Y. Dept. 12-A.

RECESSED CONTROLS

CODED CABLE

**EASTERN**   **AMPLIFIERS**

\*U.S. Reg'n Applied For



Now YOU

THIS IS TO CERTIFY THAT

Frank's Radio Service

has met the requirements to qualify as

**RAYTHEON BONDED ELECTRONIC TECHNICIANS**

*A Surety Bond Has Been Issued by the*

**WESTERN NATIONAL INDEMNITY COMPANY,**

*Expiring the \_\_\_\_\_ day of \_\_\_\_\_ 19\_\_\_\_, Bonding This Firm to:*

1. GUARANTEE ITS RADIO REPAIR WORK FOR 90 DAYS FROM DATE PERFORMED and REPLACEMENT PARTS FOR 90 DAYS FROM DATE INSTALLED.
2. Use only parts of recognized quality in its repair work.
3. Not charge more than list price for parts installed.
4. Test customers' tubes as accurately and reliably as possible.
5. Keep charges for labor at a fair and reasonable level.
6. Perform only such work as is authorized.
7. Maintain the high quality service indicated by the experience required of all Bonded Electronic Technicians.
8. Maintain and use test equipment essential to good repair work and reliable tube checking.

**Signed and Sealed**

By A. E. Anderson  
RAYTHEON MANUFACTURING COMPANY  
A. E. Anderson, District Sales Manager

By A. E. Valentin  
WESTERN NATIONAL INDEMNITY COMPANY  
A. E. Valentin, Secretary in Charge  
Dist. Office: 100 and 1/2 Jackson • 122 West Jackson Boulevard, Chicago 4, Illinois



*can become a*

# BONDED ELECTRONIC TECHNICIAN

If you can qualify for this new, revolutionary Raytheon merchandising program, you can be sure of greater sales and profits than ever before . . . and you can forget your worries about "security" in the peacetime years ahead.

This program is the perfect answer to those who have been suggesting licensing, government regulation and other impractical "remedies" to protect the public from unethical radio service dealers.

The bond certificate illustrated, showing the code of ethics and 90 day guarantee, and backed by one of the nation's largest surety firms, will be issued to *each* service dealer who can meet the necessary qualifications.

It is only one unit in a *complete* plan which includes the largest, most effective selection of displays and helps ever offered to the radio tube industry.

As a Bonded Electronic Technician, you will **STAND OUT** in your community as the **TOP** radio service dealer . . . the one to be trusted with all kinds of radio service, the one in whom the public can have complete confidence.

So for more service business, increased sales of tubes and other parts, apply to your Raytheon distributor to become a Bonded Electronic Technician. Remember, for your protection Raytheon tubes are distributed only by leading parts wholesalers.

*Raytheon*  
*Manufacturing Company*

RADIO RECEIVING TUBE DIVISION

NEWTON, MASS. • LOS ANGELES • NEW YORK • CHICAGO • ATLANTA

**RAYTHEON**  
*Radio Tubes*



DEVOTED TO RESEARCH AND THE MANUFACTURE OF TUBES FOR THE NEW ERA OF ELECTRONICS



more efficient  
...in miniature



ACTUAL SIZE

The cast iron pump was modern two or three generations ago. It was a big improvement over the old oaken bucket. But today we use a comparatively small faucet that supplies water at a twist of the wrist. It is another milestone on the road to greater efficiency in miniature.

This same tendency is evident in the development of the Electronic Tube. The Tung-Sol Miniature is the result of the trend to smaller component parts. It is used to great advantage in reducing the over-all size of equipment. But more important, Tung-Sol Miniatures do a more efficient job than the old style tube; especially in high frequency circuits. They have a low capacity and high mutual conductance. Shorter leads give them low inductance, Smaller elements weigh

less, making Miniatures more rigid. This helps to eliminate distortion from vibration.

As soon as new equipment using Miniatures is on the market, TUNG-SOL jobbers and dealers will be in a position to furnish the Miniatures as well as the G-Gt's metal and glass tubes for serving every type of equipment.

# TUNG-SOL

*vibration-tested*

**ELECTRONIC TUBES**



TUNG-SOL LAMP WORKS INC., NEWARK 4, NEW JERSEY  
Also Manufacturers of Miniature Incandescent Lamps, All-Glass Sealed Beam Headlight Lamps and Current Intermittors



TO SELL

ON

*Sight*  
AND *Sound*



**SIGHT...** Ansley Radio-Phonographs possess exceptional eye-appeal — result of the cabinet artistry unstintingly bestowed upon them by wood-working master craftsmen.

**SOUND...** Ansley Radio-Phonographs boast exceptional ear-appeal — the ultimate in tonal clarity and fidelity as created by flawless engineering techniques.

**SIGHT AND SOUND...** When your customers hear the Ansley Dynaphone, they will agree its "sound" lives up to its "sight." And that makes the Ansley Dynaphone doubly welcome.

**ANSLEY RADIO**

CORPORATION

*"Superb Tone from Records and Radio"*

41 St. Joes Avenue, Trenton 9, N. J.

LEAR DEALERS HAVE A  
★★★★★ RADIO SHOW

# ORSON WELLES ALMANAC



Every Sunday at 1:15 PM, E.S.T., Orson Welles goes on the air for Lear Radios. Seventy-eight ABC Network stations across the nation carry the Lear Radio story into the home areas of every Lear Dealer.

It's a strong opening wedge that is giving Lear Dealers quick, effective cooperation in telling people about Lear Radios that range in price from about \$500 to \$19.95.

If you have not yet investigated the Lear Franchise, get the interesting details now. Write to Lear, Incorporated, Home Radio Sales Division, 230 E. Ohio St., Chicago 11, Illinois.

## LEAR RADIO



**LISTENERS AND CRITICS  
AGREE THIS IS A  
POWERFUL PROGRAM**

★★★★

*"Congratulations on your radio commentary! You should be a great force for the public good."*

*"Your weekly radio commentary is in our judgment the finest on the air today."*

*"My only objection is the program isn't half long enough."*

*"Our most sincere appreciation of what you are doing. Keep it up."*

*"My wife and I find it stimulating and satisfying. Hope you continue for long."*

**Press, Pittsburgh, Pa.**  
*"Listen in and hold your hats!"*

**Hollywood Column**  
*"It seems to me this peaceful little scene has all the elements of an atomic bomb."*

**New Yorker, Poughkeepsie, N. Y.**  
*"He discusses books, ideas, bull fights and any other matter that happens to pop into his unpredictable mind."*

**Independent, Pasadena, Calif.**  
*"Welles is as much an individualist as was the late Alex Woolcott — the same feeling for prose and faculty of telling a story. We'd suggest you make it a point to tune in."*

**Variety**  
*"Welles is a variety of amazing talent."*

**News, N. Y. C.**  
*"Just as we knew all along, that Welles is a fine actor."*

**Enquirer, Cincinnati, Ohio**  
*"Commentary series, style and subjects unlimited."*

**Review, Rensselaer, N. Y.**  
*"Orson Welles Almanac is perhaps one of the most unusual programs on the air."*

**News, Mechanicsburg, Pa.**  
*"His talks on various subjects have proven mighty interesting, as shown by the high rating held by his program."*

*Finer in Performance AND NOW — Smarter in Appearance with*

# INTERCHANGEABLE COLORED FLANGES

**ROUND OR SQUARE... AT NO EXTRA CHARGE**



## ***Marion Glass-to-Metal Truly Hermetically Sealed 2½" and 3½" Electrical Indicating Instruments***

- 12 different iridescent colors—blue, red, green, silver, gold, etc.—in keeping with the modern trend of high-styling radio and electronic equipment. Supplied on special order at no extra charge.
- Interchangeable round or square shapes simplify instrument stocking problems; a minimum stock permits universal application of the two basic Marion "hermetic" instruments.
- The eye-appeal of these colored flanges will be especially welcomed among the ham and experimenter market. The bright colors will also lend themselves to attractive window and interior displays.

*Remember—Marion "hermetics" cost no more than most competitive unsealed instruments. And they're being delivered in ever-increasing quantities. For details of a Marion Franchise, write to our Jobber Sales Division.*



**MARION ELECTRICAL INSTRUMENT CO.**

MANCHESTER, NEW HAMPSHIRE

Jobber Sales Division: Electrical Instrument Distributing Co.  
458 BROADWAY NEW YORK, N. Y.

**"How can I get started *faster* during reconversion?"**

**"Easy! Consider these three advantages..."**

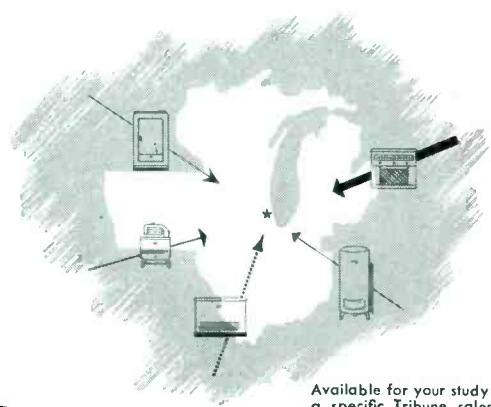
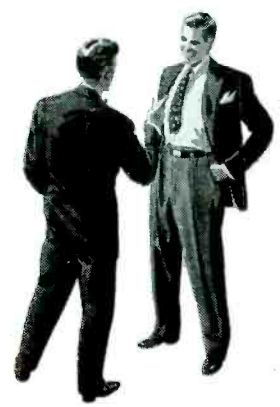

**"the market"**

Available for your study and use is a specific Tribune sales program based on the findings of an auto and household appliance investigation among dealers and consumers. To get these pertinent facts, address: C. S. Benham, Manager, National Advertising, Chicago Tribune, Tribune Tower, Chicago 11, Illinois.

"You can get quick distribution and consumer sales in the Chicago market. Sales potentials for autos, refrigerators, washing machines and 'big unit' products generally are tremendous. In one compact area—easily accessible to factory shipments and salesmen alike—is more business than in 13 states combined."



**"the medium"**

"You can get started quickly in this \$4,496,734,000 market with a single powerful advertising medium—the Chicago Tribune! One out of every three families in 756 cities and towns of 1,000 or more population in this market reads the Tribune on week days. On Sundays—almost every other family. Only the Tribune gives you a choice of monochrome, color, comic, newsprint color or black and white printing at milline rates among the lowest in the country."

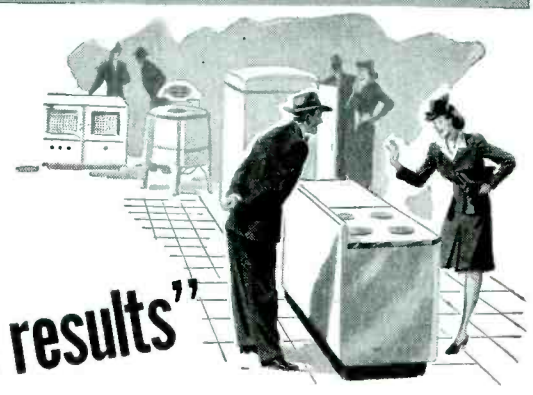

**"the results"**

"No matter whether your production is large or small, the rich Chicago market assures enough business to absorb all or the major part of your output. It offers quick sales—plus continued dealer and consumer preference when the competition starts to get tough. Why not call a Tribune representative for marketing facts and merchandising ideas?"



**CHICAGO TRIBUNE**  
THE WORLD'S GREATEST NEWSPAPER

October average net paid total circulation:  
Daily, over 1,025,000; Sunday, over 1,350,000.

GET BACK OF THE RADIO LINE  
THAT'S ON ITS WAY TO THE FRONT!

# *Sell General Electric*

**NO OTHER LINE HAS ALL THESE FEATURES!**

- ★ G-E Alnico 5 Loudspeakers
- ★ G-E Electronic Reproducer
- ★ G-E Self-Charging Portables
- ★ G-E Frequency Modulation
- ★ G-E Protected Record Changers
- ★ G-E Superior Quality
- ★ G-E Appearance Appeal
- ★ G-E Positive Performance

So many people want a G-E Radio right now that General Electric couldn't supply the present demands if it had twice as many plants.

NO OTHER LINE IS BACKED BY SUCH EXTENSIVE ADVERTISING CAMPAIGNS TO YOUR CUSTOMERS!

NO OTHER LINE HAS THE ADVANTAGES OF SUCH EXTENSIVE EXPERIENCE IN THE MANUFACTURE OF WARTIME ELECTRONIC PRODUCTS!

THE HOTTEST LINE IN RADIO TODAY... AND PLENTY MORE MONEY-MAKING MODELS COMING!

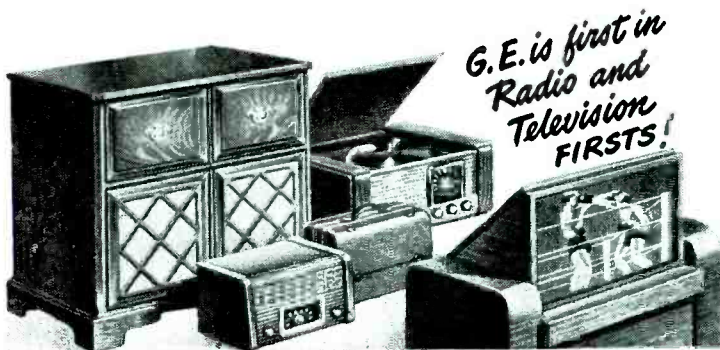

**SEE YOUR NEAREST G-E RADIO DISTRIBUTOR!** Find out all about the features, sales policies and promotion plans of the new G-E line. See your nearest G-E Radio Distributor or write:

*Electronics Department,  
General Electric Company,  
Bridgeport, Conn.*

**GENERAL  ELECTRIC**

178-D12

PORTABLES · TABLE MODELS · CONSOLES · FARM SETS · AUTOMATIC PHONOGRAPH COMBINATIONS · TELEVISION



**HALF THE SIZE!**  
*and twice as good!*

**R**EMEMBER back in pre-war days when anything less than an exact duplicate condenser replacement simply wouldn't do? Condensers were big as half a pound of butter and weighed almost as much. Today, you can replace any of those old "giants" with a Sprague Atom midget dry electrolytic less than half its size—and twice as dependable by any electrical standard of comparison you care to name. What's more, compare Atoms with any similar midgets and you will find they are smaller than most—and far and away the most dependable of the lot!

**Sprague Products Company, North Adams, Mass.**  
*(Jobbing Sales Organization for Products of the Sprague Electric Co.)*

**6 TIMES  
 HONORED FOR  
 DISTINGUISHED  
 SERVICE**

... by the Army-Navy "E" Flag Award, by four star awards, and by a special ordnance award for work on the famous VT fuze.



# SPRAGUE ATOMS



**THE IDEAL REPLACEMENTS FOR ALL DRY ELECTROLYTIC CAPACITOR TYPES**

No. 1 IN A SERIES OUTLINING FADA'S COMPLETE DEALER PROMOTION PLAN

# POINT OF SALE

*dealer helps*

**THAT SELL!  
AS THEY TELL!**



Our dealer help plan is so thorough and so extensive that it will gladden the heart of every Fada dealer. From national advertising to point-of-sale promotion, we haven't overlooked a thing.

For example, here are two beautiful neon-light signs available to our authorized dealers. These signs add drama to your display rooms; they attract crowds of new customers to your place. Yes, they build radio sales — Fada sales — because they emphasize the point that Fada radios have been "famous since the very beginnings of radio reception". Both are signs that "sell as they tell".

Write for detailed information on Fada dealer franchise.

YOU CAN ALWAYS DEPEND ON

# FADA Radio

OF THE FUTURE

*Famous Since Broadcasting Began!*



**FADA RADIO AND ELECTRIC COMPANY, INC., LONG ISLAND CITY, N. Y.**

# How a surgeon's hand slipped and made

# women lovelier...

It began in the operating room of a Cincinnati hospital, grew in a family kitchen, and ended up in America's medicine chests. Odorono, the trusted deodorant, was created because a surgeon was annoyed.

His hands perspired — sometimes so much that surgical instruments slipped out of his hands during operations, back there in the early 1900's. He couldn't take such risks.

So he started trying to find a remedy. One combination of chemicals seemed to work well. His friends tried it — they liked it, too. The surgeon was satisfied, and that's all he did about it.

But his daughter saw that her father had discovered something important to a lot of people, and decided it should be made available to them. In the family kitchen she began making and bottling his perspiration remedy. They named it Odorono and sold it from door to door. Sales increased, because people liked it. Pretty soon there was enough money for some Odorono advertising in national magazines.

That first Odorono brand advertising, somewhere around 1910, was big news for women. Now they didn't have to fool around any longer with home-made concoctions to check the perspiration nuisance. Now they

could buy a safe, easy-to-use deodorant that assured new daintiness. They'd wanted one, oh so long.

Ever since those days, as more and more deodorants have appeared nationally and made their brand names familiar, deodorant advertising has helped everybody. It has made cleanliness much easier, lasting charm much more convenient. It has shown women how to overcome one of charm's chief enemies. Deodorant brand advertising has educated us to new comfort.

Brand advertising always benefits us. It introduces us to products that *must* perform better. It makes life more convenient, more comfortable. It consistently saves us money.

Compare prices, to prove those savings. The mass production arising from the mass demand stimulated by brand advertising cut the per-horsepower cost of your automobile engine from \$31.50 in 1925 to \$9 in 1940. You paid \$167.50 for a radio in 1928 — could get a better one of the same make, for \$9.95 in 1941. In fourteen years, nationally advertised refrigerators dropped their price \$170!

You wouldn't enjoy America without brand advertising.



## It happened to **GOODYEAR**

\$35.60 in 1910 — but \$14.75 in 1941

A known name, like Goodyear, has been a guarantee of value on tires ever since the national advertising of Goodyear and the other tire makers taught us to demand quality. We trusted, bought, were satisfied — and the mass production of good tires that our buying created kept pushing tire prices down.



### FREE REPRINTS OF THESE STORIES OF "WHY AMERICA'S GREAT"

This series of newspaper and magazine advertisements is offered as a public service by Fawcett Publications, Inc., 295 Madison Avenue, New York 17, N. Y. Write for free proofs.

**FAWCETT PUBLICATIONS, INC.**  
WORLD'S LARGEST PUBLISHERS OF MONTHLY MAGAZINES



**"Head Start!"** America's millions everywhere — consumers, distributors, dealers — are set for the **BIG BUSINESS** of new, postwar

# Emerson Radio

With widespread demand firmly established for specific **NEW** models—featured in an unprecedented **CONTINUING** advertising and sales program—

With **THREE TIMES** pre-war capacity for producing as fast as materials are available—

With equitable merchandise allotments for all territories, and **SOUND POLICIES** that insure the **UTMOST RETAIL PROFIT**—

Emerson Radio dealers are going ahead—booking more and more orders, solidifying their position to capitalize the most valuable franchise in the radio industry—the **INDISPENSABLE** line!

## The **INDISPENSABLE** LINE

Regardless of other makes carried, Emerson Radio is the dealer's **INDISPENSABLE LINE** because—

1. It is the recognized **LEADER** in the largest "demand" division of the radio business;
2. It has **BETTER** Style, Tone, Performance and Value—with models for every purpose and every purse;
3. It has the greatest consumer attraction—in advertising, windows, radio departments—brings more people into stores for radio and other merchandise;
4. It enables dealers to stock more merchandise with less investment—satisfying more customers and insuring more rapid turnover;
5. It links the dealer with **PROGRESSIVE** electronic development—"great engineering ideas in small packages."

*For the complete story, call your Emerson Radio Distributor.*



*Rolling Off the Lines as Fast as Materials Roll in!*

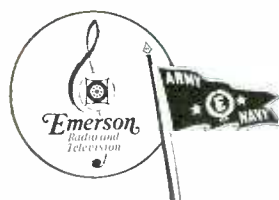

*World's Largest Maker of Small Radio*

**EMERSON RADIO AND PHONOGRAPH CORP. • NEW YORK 11, N. Y.**

Why authorized dealers make  
Stromberg-Carlsons the main  
radio in their showrooms



The **AUTOGRAPH**—Standard, two FM bands, two short wave bands with spread-band tuning. Carpinchoe speaker, Acoustical Labyrinth for utmost fidelity. Engineered for wire recording.



The **DYNATOMIC**—Ultra-modern in design! 3-gang condenser for "big radio" performance. Concealed hand-hold for portability.

One reason (among many) is:

they're



The **HEPPLEWHITE**—Standard, two FM bands, and short wave band with spread-band tuning. Engineered for wire recording.

new!



The **NEW WORLD**—Unique disappearing doors! Standard broadcast, two FM bands, short wave band with spread-band tuning. Engineered for wire recording.



The **BEAUX ARTS**—Compact automatic radio-phonograph. 3-gang condenser. Standard broadcast and spread-wave short wave band. 6 station push buttons.

**Y**ES, the new Stromberg-Carlsons are really new. New in advanced engineering. New in beauty. New in the far wider range of customers they serve. New and finer Stromberg-Carlson reception and reproduction.

And then just look at these features. All but one of the table radios have 3-gang condensers—a feature hitherto found only in radios selling at two or three times their price! "Big, expensive radio" performance, sharp tuning and a minimum of noise between stations.

All FM receivers employ the genuine Armstrong FM system for virtually staticless reception. All FM receivers are *engineered* and fitted for addition of wire recording units. All have two FM bands, for both present and newly approved FM frequencies. All have spread bands for accurate tuning of international short-wave programs.

The new phonographs are quieter—speedier—fitted with replaceable needles. The *Autograph* has the famous Stromberg-Carlson patented Acoustical Labyrinth and Carpinchoe speaker. Other FM receivers have "full floating" speakers, mounted in live rubber for clearer tone.

**STROMBERG-CARLSON**  
ROCHESTER 3, NEW YORK

*Radios, Radio Phonographs, Television,  
Sound Equipment and Industrial Systems, Telephones,  
Switchboards and Intercommunication Systems.*

# RADIO & Television RETAILING

Including Radio and Television Today

O. H. CALDWELL, Editor \* M. CLEMENTS, Publisher \* 480 LEXINGTON AVENUE, NEW YORK 17, N. Y.

## **FINANCIAL INDEPENDENCE FOR YOU!** **Independent Dealer Can Start Building an Estate in 1946**

In 1946 the "independent dealer" can start building an estate that should bring him financial independence during the next few years!

For all signals are set favoring the independent merchant's business success during 1946 and the years to come—if he displays business prudence.

Let's look over the factors that, despite current OPA headaches, give a green light to radio/electrical-appliance selling in 1946:

1. The public is prosperous as never before. All classes have money to spend. Prices may be expected to remain firm.
2. People are radio/appliance hungry. Old equipment needs replacing; several million new families are settling down to normal living and need complete equipment.
3. Already the pioneering has been done in radio-appliance selling. Already millions of established homes are "half-equipped." Selling the second half should be easier, less costly, than the back-breaking initial sales.
4. The utilities—formerly the independent dealers' worst competitors—have been forced by the public-service commissions to abandon or reduce activities in both merchandising and servicing, leaving these fields to the independent business man.
5. Chain-store competition with its careless indifferent personnel has proven no match for the alert friendly customer service of the independent dealer. The chain store boogey-man frightens no more!
6. New merchandise lines like FM, television, automatic washers, room coolers, dish washers, etc. beckon the independent dealer on to future volume now unguessed.
7. With his entry into the home—and into the confidence of his customers—assured by dependable maintenance and repair service, the independent radio/electrical merchant is in unassailable position to meet future competition from any quarter.

That is why we feel that the independent dealer—after going through the struggles and crushing disappointments of recent years—is at last coming out into the bright sunshine of prosperity.

In 1946 he will lay the foundations for financial independence. In the following years he will be able to build his nest-egg into an estate of comfortable proportions.

You—Mr. Independent Dealer—are most certainly on your way!

# RADIO, Electrical Appliances,

**RADIO SET DELAY** due in a great measure to shortages in steel, electric wire, aluminum containers as well as to short supplies of variable condensers and speakers. Another factor has been the pricing delay, and, believe it or not, some manufacturers are finding it difficult to obtain enough skilled help, complaining that workers are becoming more and more "temperamental."

**300,000 MORALE RECEIVERS** for the armed services, have been holding up such civilian radio production as has been possible. These "morale" sets get priority on materials and production before home radios which must wait until the armed-services' sets are off the production lines.

**NEW TELE XMITTERS 1947?**—Video licensees appearing before FCC testified they have recently sought to order television transmitters but best promise to get on air for low-frequency band (44-88 mc) was January, 1947. For the upper television band, no date whatever would be promised.

**RADIOMAN "SHOPPING"** A LARGE DEPT. STORE found they had a total of but three radio receivers on hand though they had used a large newspaper ad inviting customers to call and "take home" a set.

**ROOM COOLER SALES POSSIBILITIES** enhanced as a result of ability to make much lighter electric motors, quieter compressors. Industry sees a 500,000 unit market when production volume will allow retail price of about \$125 each.

**MODERNIZING COMBOS** to 1946 levels of fidelity and performance will be possible with new-method pick-up and pre-amplifier being developed in mid-west. With this novel pick-up, ready in January, servicemen and dealers should find profitable business in rebuilding pre-war phonograph units to latest tonal standards.

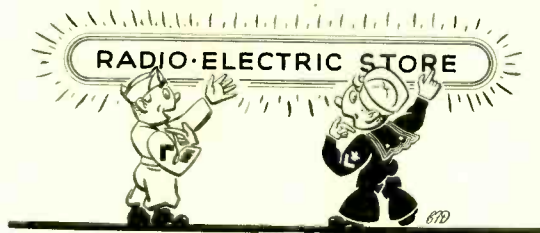

**RADIO/ELECTRIC SHOPS FIRST**, seems to be verdict among returning service men who want to start up their own businesses, according to U. S. Commerce Department which now gets 225 letters from vets daily. Questions about starting radio/electric shops are first in number; then come restaurants, filling stations, apparel stores, groceries, real estate and insurance offices.

**ABOUT A HALF-MILLION RADIOS** by Christmas instead of the 3,500,000 figure set as an estimate by WPB a few months ago seems to be approximately what the nation's dealers may expect. A cheerful aspect of this picture, though, is that the receiver-hungry public is not buying those "loft" sets having high OPA price tags—offered in various chain stores.

**BEWARE OF SPECIALIZATION** counsels Paul B. Zimmerman, master electrical sales manager who, as Vp, now monitors Monitor. Keep a balance of lines and a balance of stock advises "Zim." If the dealer tends to specialize on some part of the radio/electrical field, he will suffer seasonal peaks and will miss other household sales to customers who would have given him first call, had he had the stock on hand.



**DEMANDS KEEP PILING UP** for new radios and appliances. Consumers, manufacturers, wholesalers and retailers have had their hopes alternately sky-rocketed and depressed so many times recently that all are becoming dizzy. Some dealers are reporting headaches concerned with customer demands for return of deposits placed with them. Jobbers and manufacturers are being swamped with calls for information. "Undercover" selling of scarce items to "pet" customers is becoming more widespread.

**HOW WIMMEN BUY**—Only half of the traffic passing through a department store in any one day makes a purchase, statisticians report. And of those who do buy, only half purchase as much as they intended or could have been sold. In all, roughly 80 per cent of sales are directly accountable to in-store traffic, say department store execs.

**71% TURNED OFF HI-FIDELITY**—Frank Mansfield, Sylvania researcher, found that most persons interviewed, who have no FM, felt that FM's high fidelity would be its chief attraction and reason for buying. However, interviewers of actual FM owners who watched them tune their receivers, observed that 71% did not take advantage of high fidelity at all; 19% did; 10% said they didn't know how—nor care.

**APPLIANCE MODELS CUT**—GE electric clock models have been reduced from pre-war total of 78, to 38 for 1946; fans from 60 to 23, electric irons from 19 to 5; water heaters from 660 to 50.

# Records, and Television, TODAY

**PHILCO PLANS TO MAKE 4 MILLION SETS** in 1946, according to a statement made by John Ballantyne, president, at a showing of the company's line of 43 models. The figure is about twice as high as the firm's production in its last peace-time year. Philco-designed "Advanced FM circuit" is a feature of some of the receivers, and a new line of record players and changers was introduced.

**TELEVISION VIA COAXIAL** will be featured in New York-Philadelphia-Washington area during 1946, when AT & T starts exchanging video programs between three cities. Coaxial cable (which during day is used for 480 simultaneous phone messages) will be made available for video to NBC, CBS, and DuMont each two nights weekly, without charge. Tryout came December 1, when Army-Navy football game at Philadelphia was viewed by WNBT audience in New York courtesy SEPost.

**RADIO NEWSCASTS FOR STONE-DEAF**—A method of visible oscillograph recordings of speech, just demonstrated by Bell Telephone Laboratories, may some day result in a home radio attachment by which totally deaf persons can clearly understand any news broadcast. Method will first be developed to enable stone-deaf to "see speech" traces of telephone conversations and so interpret ordinary spoken words.

**TELEVISION PREDICTION** by Du Mont's Paul E. Carlson: "Barring unforeseen difficulties, the industry as a whole should be able to produce and sell upwards of 500,000 receivers in the first year or 18 months after reconversion is complete."

**THEY LIKE TV AS IS**—Gillette Razor, which along with Lever Bros., is a principal sponsor of television programs, recently asked 4252 teleaset owners about clarity of image on their sets. Replies received numbered 1070; 45.6% reported "very clear"; 44.9% "fairly clear". Of course all sets involved are pre-war.

**\$100 RADIO-RECORDER** is promised by mid-west manufacturer, for early announcement. This table-model outfit will employ iron-wire recording unit, in combination with radio set.

**JOHNNY-COME-LATELY MANUFACTURER** granted an "in-line" price of \$5.50, retail, for a hand iron—a new line with him—while a veteran maker of quality products was refused an increase of about 20 cents on his iron, a comparable model, which would have retailed for \$2.75.

**CHICAGO'S PRODUCTS OF TOMORROW** Exposition will open in the Coliseum April 27, to run 22 days. Consumer products in wide variety will be shown.

**DECCA EXPECTS TO SELL A MILLION** records of its new release which teams Bing Crosby and Bob Hope. The disc sells for \$1, and is being merchandised under the firm's "Special Series" label.

**1200 KW-HR PER YEAR** is present electricity user's consumption. In 1930 average home use was 550 kw-hr, up from 365 kw-hr or one kw-hr per day in 1925. Present electricity price averages one half of the price per kw-hr in 1913, although general living costs have since doubled.

**IT'S A WISE SERVICEMAN** who recognizes own stolen radio. Bill Balmer, East Orange, N. J., radio-man had a small set disappear from his home. A couple of days later a 10-year boy brought the same set into the Balmer radio repair shop, explaining "It doesn't work." The boy admitted his theft and police committed him to the local correctional institution.

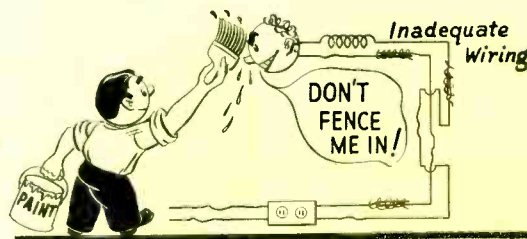

**REPAIRS, REMODELLING, REDECORATION** planned for thousands of existing homes may "seal up" innumerable old-fashioned, inadequate wiring systems, barring full use of electric service, and cutting retail sales of electrical appliances. Manufacturers, jobbers, dealers should interest themselves in all movements for adequate wiring. You can't add equipment to "can't-take-it" circuits.

**ELECTRICAL HOME HEATING** is on the production agenda at Westinghouse. Firm plans to make models ranging from 1250 to 4,000 watts. Major markets are expected in California, Washington and Oregon. Under ordinary conditions, a heater will be installed in each room. Sales will be routed through the company's already established distributor and dealer channels.

---

In This Issue—**THREE MAGAZINES IN ONE**, covering **RADIO; ELECTRICAL APPLIANCES; SERVICE**  
Latest Radio Merchandise, pages 44, 45, 46, 47, 48, 49  
Newest Electrical Appliances, pages 70, 71, 72, 73  
New Things for Service and Sound, pages 80, 85  
Listing of Radio Manufacturers, page 60  
Listing of Electrical Appliance Makers, page 76

# Spotlight

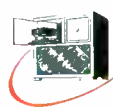

• More sales and greater profits for retailers, distributors and manufacturers of radios and electrical appliances is the exciting outlook heading the picture for 1946—the great New Year now right around the corner.

1946 will also be a banner year for the merchandise-starved consuming public which has been buying inferior war-time new things or re-built used ones or has been calling on dealers to patch up time-worn radios and appliances in order to make them "do" for the "duration".

In addition to supplying the familiar types of radios and appliances, the manufacturers will have many entirely *new* products before the New Year is out.

Another good and encouraging sign on the horizon of the New Year is the awareness on the part of manufacturers and merchan-

disers to the necessity for *better* and *more profitable* selling practices.

1946 will be a "clean" selling year. We're all starting off from scratch—starting off with a fresh viewpoint.

So long as merchandise continues to be scarce, dealers and distributors will be able to make money even under the reduced margins now in effect.



The price law is scheduled to end next July, but there is agitation afoot which may result in its continuance after July, 1946.

Since it does not seem possible that production can make sizable inroads into the existing demand within the next six months, "clean" selling should continue for some time.

The industry eyes entry into a year of ethical selling practices



through rose-colored glasses. Not only are the prospects for profitable merchandising better than they ever were before, but the prospects for large volume sales was never greater. With an estimated 20 million out of the 60 million sets now in consumers' hands out of order or obsolete, the potential market is of prodigious size.

In addition to the pent-up demand for home receivers the radio industry sees many other exciting and money-making angles to the sales picture. No one can accurately gauge the existing demand for record players, nor can anyone determine at this time how many "straight" record players will be purchased in *addition* to combinations by consumers. One industry



executive foresees investments in new FM stations and receivers totalling about two billion dollars within the next 5 years.

Television, which promises to begin rolling in 1946, will result in added income to the radio industry. It seems safe to predict that the makers will be able to sell *all* of the receivers they can produce in '46. Program coverage will expand greatly during the latter part of the coming year, and by the end of 1946 we should see this great public-accepted art ready to climb to unbelievable heights during the following years. Television broadcast revenue will be readily forthcoming from video-minded advertisers all over the world.

Facsimile, walkie-talkies, domestic and commercial aviation radio, radar, and scores of other electronic industries' products stand ready to go places in the coming modern market.

Within the next two or three months the FCC will approve rules and licensing methods for walkie-

## IN 1946, LOOK FOR —

- "Clean", profitable seller's market
- Unsatisfied demand for radios, appliances
- Possible extension OPA pricing laws after July 1
- Some "radically new" models in last quarter
- FM to boom with radio industry
- All television sets made will be sold
- Personal radios will be smaller—sales greater
- New developments in walkie-talkies, facsimile, plane radio
- Growing demand for electric ranges, food freezers
- Also room coolers, dishwashers, disposal units
- In last quarter, a few "different" refrigerators
- Records, record players, to sell like hot cakes
- Automatic washer competition to increase
- New interest in small appliances
- Return of necessity for aggressive selling

on

# 1946

talkie use. FCC plans to make rules and requirements as simple as possible. Commissioner E. K. Jett predicts that 25,000 of the portable 2-way sets will be in use by the summer of 1946. Unit prices of sets will probably range between \$50 and \$100.

Auto radio sets will be produced in great numbers to take care of the vast number of new cars scheduled for production and for the used-car market, growing by leaps and bounds now that restrictions on travel have been lifted.

Hams will buy heavily in 1946, and an increase in the number of amateurs seems definitely assured.

For the most part, 1946 receivers will not be of "revolutionary" design, as few manufacturers will take chances on attempting to offer "bizarre" equipment in such a strong seller's market.

However, if full production gets under way soon, it is quite likely that we shall see many new selling features, fairly approaching the "dream" model type, late in 1946.

Since multi-purpose tubes are being widely used, and since the public has been educated to gauge set values on the number of tubes, manufacturers are developing new selling technique which will also be employed by the retailer at the point of sale. For example, the buyer will be told that a set has "eight tube performance in a six-tube circuit through the employment of dual-purpose tubes." Then, too, prospective purchasers will be told more and more about "watt output."

"Sound" promises to make itself heard in a greater fashion than ever before. Public address systems, intercommunicators, etc., have truly gone places during the war, and improvements in them have been so phenomenal that most of the pre-war equipment is passe. The new market and the replace-

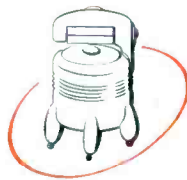

ment market for "sound" is practically virgin sales territory.

Factories, offices, amusement parks, churches, homes, schools, sports stadiums, farms, hotels, banks, restaurants, etc., will buy "sound" equipment in a big way and will also contribute to swell radio's gross business during the coming years.

Radio, which at the time of the Harding-Cox election return broadcast in 1920 had 50 listeners and which had a million times 50 listeners during the 1945 World's Series, has come a long way during the past quarter-century, and the promise it holds out for the near future bids its industry participants to agree that "we ain't seen nothing yet".

Sales of phonograph records and recording services will boom to new heights in 1946. Records have gone great guns all during the war, with millions who had no record players watching enviously along the sidelines as those fortunate enough to own their own players sought and bought discs vigorously in a short market.

Wire recording and other recording methods appear to be in for aggressive development and merchandising from now on and will contribute to the great and growing interest in records in general.

Like radio, electrical appliances do not seem to be in for any drastic design or performance change in 1946, and here too, a lot depends upon production quantities. If production commences catching up with the demand, then, without doubt, many makers will bring out "startlingly new" products to enhance their bids for business.

Right now nothing more than a trickle of appliance merchandise is coming into the market. Pricing squabbles, strikes and material shortages have all contributed to the picture, but one of these days—and soon, production lines

will be humming full blast, and jobbers and dealers will begin receiving merchandise in quantity.

Many new trends are noted in electrical appliance manufacture. Refrigerators are in great demand, and something new has been added to many of them in the form of food freezing compartments. Cabinet design seems likely to remain in its familiar pattern, but it is possible that a few "dream models" will commence appearing late in 1946.

Food freezers themselves are being actively merchandised now,

(Continued on page 124)

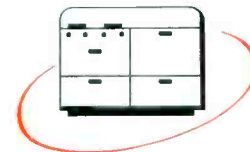

# Radio Store Within A

California Retailer "Goes Modern" in a Big

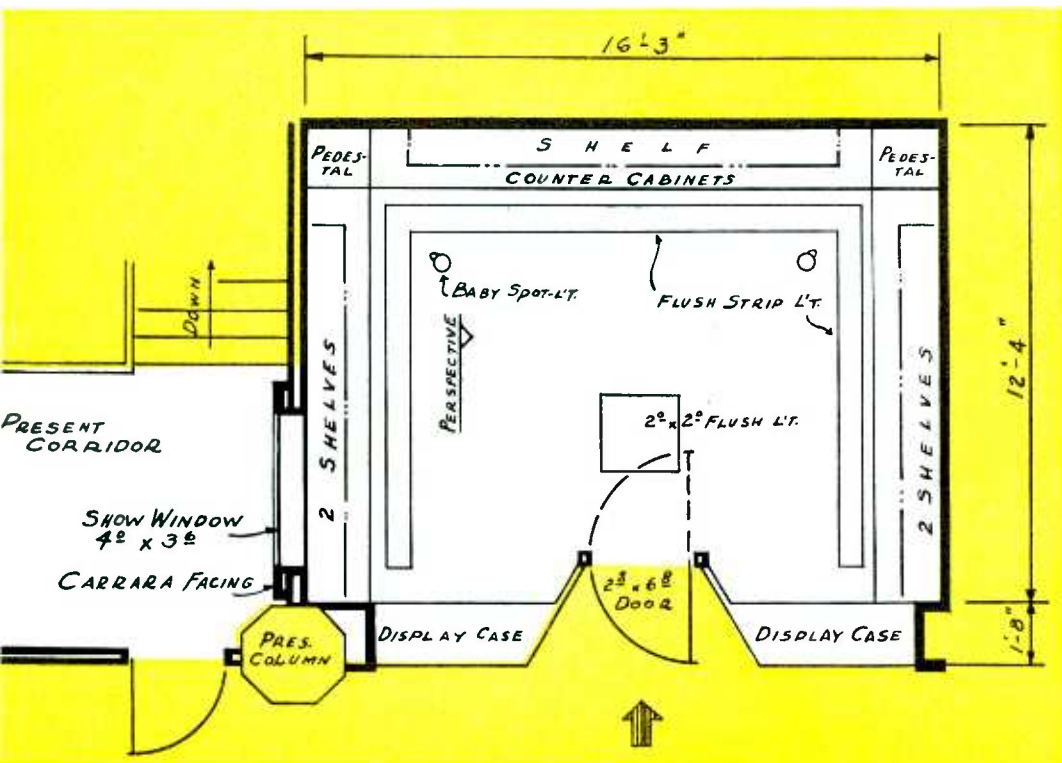

FLOOR PLAN  
SCALE: 1/4" = 1'-0"

Detailed layout of "inside store". This idea is expected to increase table model receiver sales.

• A "store within a store" is one of the features to be provided at the new Humphreys Music Co. establishment, Long Beach, Calif., to focus attention on the small radio department.

The firm, merchandisers of radios, electrical appliances, musical instruments and related goods, is convinced that this idea is unique—different—which will help it to get a large volume of business.

By making "two stores out of one," the establishment has already attracted considerable interest. The organization feels that it can get more turnover—and much more profits—by selling table model receivers in a "separate store."

The company, located at 130 Pine Ave., has purchased the entire three-story building where it has been located for many years, and will devote all three floors to the expanded, modernized Humphreys program.

Headed by J. I. Strom, the radio

department will form the keystone of the remodeling and expansion plans. Table model sets will be displayed and demonstrated on the main floor of the store, with combination sets and larger receivers on sale in the mezzanine. Radio service and rentals, an important phase of the department's business during the war-time period, will be continued as a sideline.

### Plan for More Profit

Small sets, however, will be shown in the attractive "store within a store" on the main floor, rear left, bearing the name "Humphreys Radio Shoppe." Eye appeal for the shop will be obtained by a combination of glass brick, plate glass, and well-lighted showcases set into the windows.

The "store front" of the "inside store" is designed to attract many new prospective customers. Strom has provided for a division of the "small radio store" into two sec-

tions, both of which will be assigned to displaying well-known makes of table model receivers.

The front half of the mezzanine floor, connected to the street floor by elevators, will be devoted to demonstration rooms for phonographs, and radio-phonograph combinations. These models will also be displayed on the street floor. The soundproofed demonstration rooms, similar to the smaller booths in the record department will assure the customer maximum listening comfort.

### Prepare for Large Volume

Front window display space for the entire building has been increased by the annexation of an adjoining camera store, now separated from Humphreys by a wall partition. This partition will be removed in the remodeling program and the window space of the new establishment will be available for radio and music display.

The camera business will be operated as a "concession", and floor space for display will be greatly enlarged by combining the two stores.

Display space will then extend across the width of two store fronts, half-way back from the main entrance toward the rear of the store. Desks of department heads, now placed on the left near the entrance will be shifted to a less prominent position midway on the right side.

The rear left half of the street floor, after modernization, will include the new "store within a store" for small sets, and the sheet music department. On the right will be the record department, a band instrument counter, and department desks.

The piano and radio service department, at the extreme rear of the street floor complete the arrangement.

The front mezzanine, divided into two sections above the street display window, will provide for the demonstration of phonographs and radio combination sets, while the rear section of the mezzanine, above the record and sheet music departments, will house piano and band salesrooms. Practice rooms, furnished with an electric organ and pianos, and which are rented



# Store to Double Sales

## Way to Boost Set Purchases, Create Interest

to teachers and pupils at 25c an hour, are also located here.

In order to sell customers who need electrical appliances which are now becoming available, Humphreys has provided a sales room for kitchen ranges, refrigerators, washing machines, etc., in the base-

ment of the store. The basement department, also connected to the street floor by elevators, will display used pianos and provide storage space.

The rental of radios, which grew to large proportions during the war, will be continued, inasmuch as the

area around Long Beach will continue to house large numbers of Naval personnel, who as temporary residents, furnish a large volume of rental trade.

Radios for rent on a monthly basis have been shown on a three-tier (Continued on page 120)

"Look-in" view of the "inner establishment". Customer's attention is focused on this department to speed turnover. This "store" is the chief feature of the company's expansion program, which is aimed at high profits.

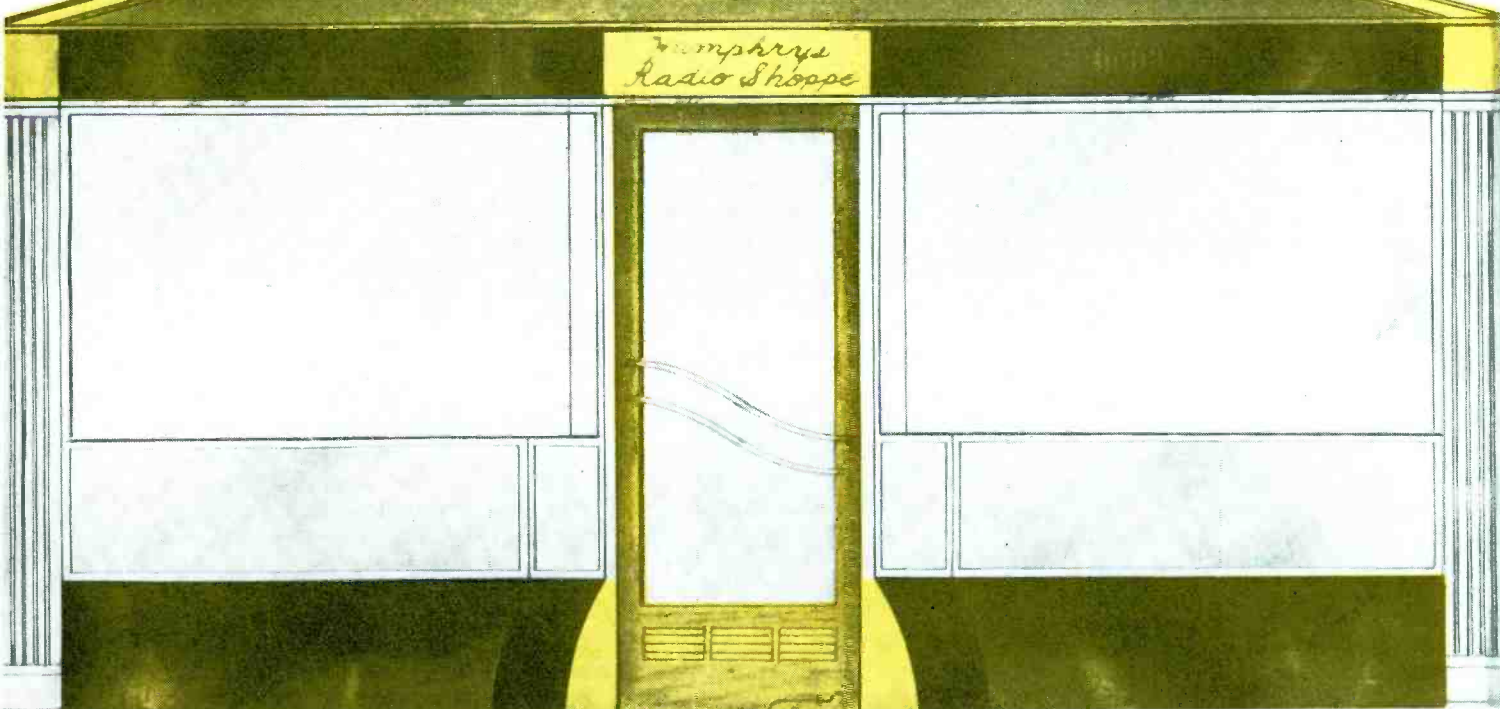
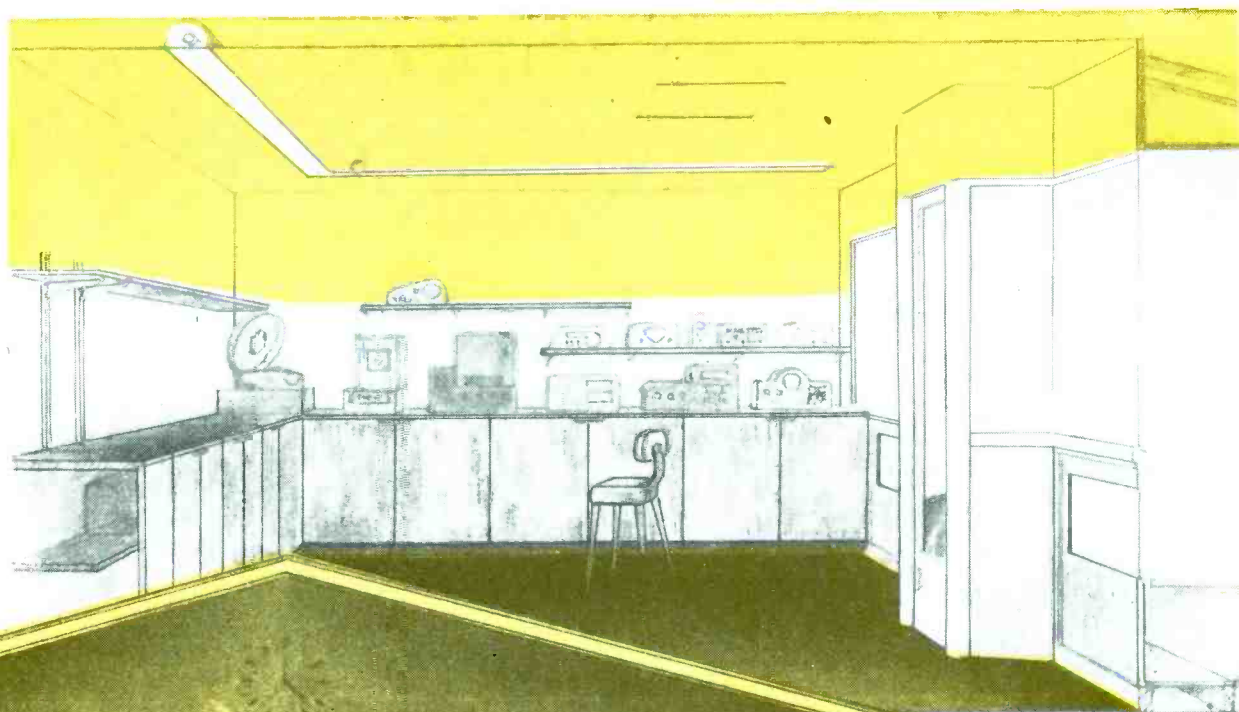

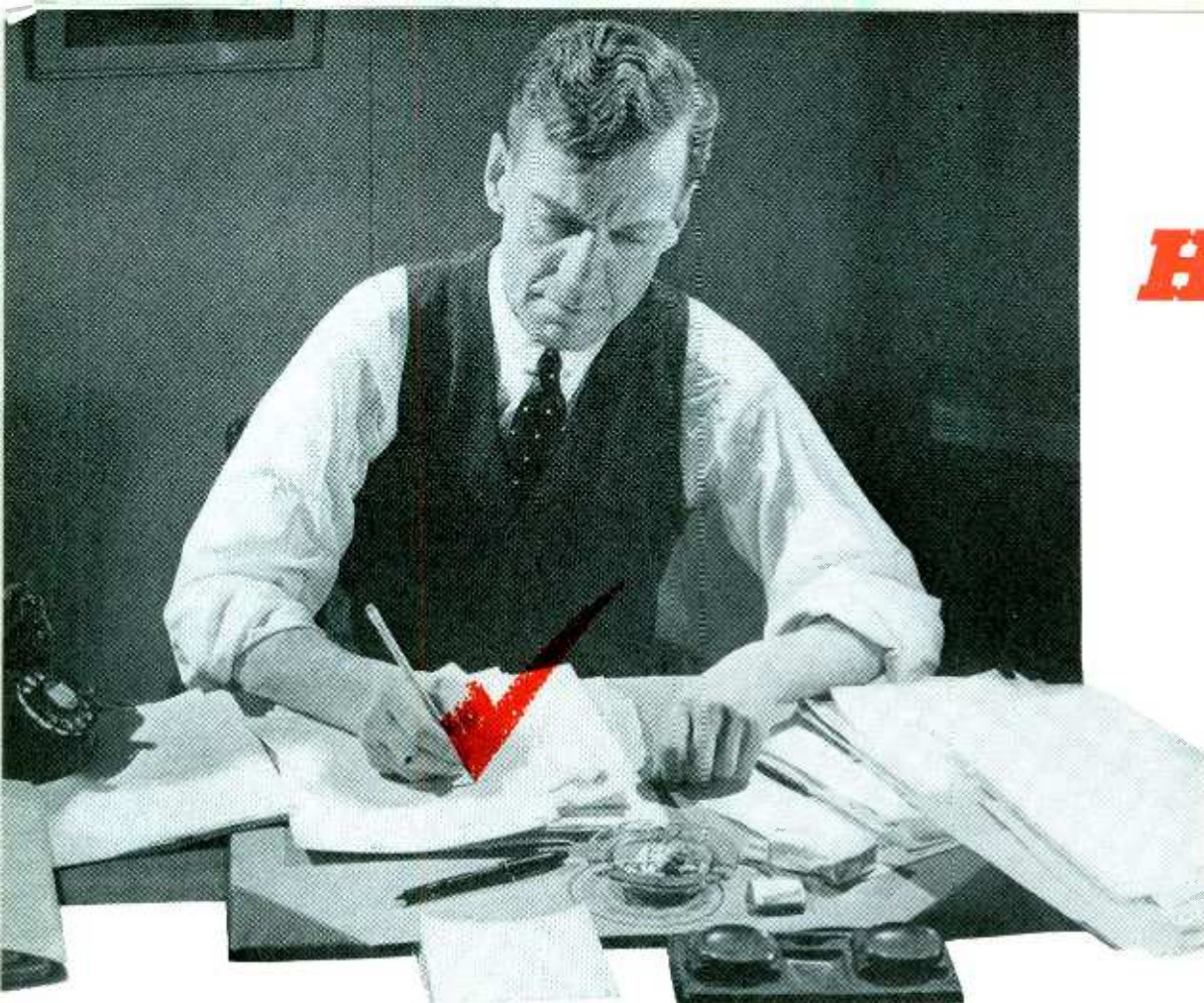

# HOW and

Merchants can avoid gray hairs and sleepless nights by paring top-heavy "fixed expenses." Income from new goods can be increased by weeding out the take-it-for-granted profit-eating costs.

## **With Less Margins, Upped Operating Costs, Dealer Must Reduce Expenses in All Departments of His Business**

● There are two profit-affecting conditions facing retailers today.

1. Margins have been reduced.

2. Selling expenses have increased.

So long as the present demand for merchandise exists, the dealer will doubtless make as much profit as he made in the past, since he will not have to handle unprofitable trade-ins or offer other inducements in order to obtain sales. However, when competitive selling returns, this picture will change.

If the OPA regulations reducing profit margins are still in effect when the days of "wrap-up" sales are over, the dealer will be hard put to operate under the reduced discount rates. Just when "competitive" selling will strike again cannot be accurately forecast, but one of the foremost merchandising authorities in the country asserts that he firmly believes such time will be "three months after manufacturers in this field have reached full-scale production."

Regardless of what the dealer's guess may be concerning competi-

tion's reappearance, he should project his planning now so that he will be able to cope with the situation when he finds himself faced with it.

In order to prepare to do a real selling job in this modern market, the retailer has found it necessary to increase his expenses. He has had to modernize his store, increase the number of employes, spend more for advertising and delivery service and conduct all other phases of his business on a more costly basis.

### **Sales Will Cut Service**

While it is true that many dealers see prospects of reducing costs of operating their service departments, this will only be brought about because of a decline in service work. The more new radios and appliances that are sold the smaller the repair volume will be.

On the other hand, the merchant has no cause to be discouraged. He is on the threshold of an era promising greatly increased sales vol-

ume, and despite the fact that it will cost him more to handle this business, and that his discounts will be lower, he can still make money—and lots of it—if he buys carefully, sells aggressively and cuts down all unnecessary expense.

### **Chop Unnecessary Costs**

The merchant cannot control the discount rates allowed him, nor can he side-step the necessity for spending more money to do more business, but he can scrutinize every department of his business so that he can figure out where and how to eliminate all needless expense.

The retailer's business, like a fruit tree, needs skilful pruning. The experienced orchardist knows that he must trim out all sections of the tree which he knows will not contribute to producing fruit, while obtaining nourishment from the roots. By the same token the merchant should cut out all unproductive expenses eating into the profit roots of his establishment.

# **WHERE** to Cut **Profit-Taking Overhead**

Since many of the unnecessary expenses are "hidden" expenses or are of the "take-it-for-granted" variety, the retailer needs to make a thorough examination of his costs so that he can do a thorough job of "cutting"—not merely one of eliminating a few of the most obvious profit-robbing expense items.

## **Money-Saving Tips**

Delivery expenses can be cut in most cases through insistence upon the part of the dealer that calls be routed so that there will be no time lost going over the same routes more than once daily, etc. "Aimless" delivery methods cost money in time and they cost money in gasoline, oil and wear and tear to the equipment.

Slipshod collection methods should be done away with. Collection calls should be arranged by neighborhoods in order to save money, and collectors should be compelled to call back again on dates and at times suggested by the customer. Amounts of the bills themselves should govern the amount of time which can be profitably devoted to them. It is better to write off a small bill than it is to spend more than the debt's value in trying to collect it.

Needlessly complex bookkeeping methods should be done away with and efficient, easy-to-operate ones installed in their place. Cumber-some accounting and record-keeping systems require too much valuable time. Moreover, unwieldy systems are usually understood by but one person in an organization, and when other employes need to "look things up" they are often confronted with a time-wasting, futile task.

## **Simplify Book Work**

It is often possible for the dealer to save real money in simplifying his accounting system, cutting out lost-motion, duplication, etc. Adequate records are vitally necessary — more-than-adequate ones are unnecessary overhead.

The merchant should never keep "drones" on his payroll. He must elect to be hard-boiled about this proposition because unproductive persons on his payroll are one of his most costly liabilities. Now is the time for the dealer to "clean house" along his personnel lines. He's had to put up with all kinds of help—good, bad and indifferent because of the severe manpower shortage, but conditions are changing rapidly, and it is now possible for him to select his staff members—not merely accept them as he was formerly forced to do.

## **Employes Must Produce**

In the coming market the dealer cannot afford to shadow-box with "problem-children" on his payroll. He must take a firm stand and get rid of all those who cannot or will not put themselves in "war's over" attitudes.

Inefficient, lazy employes, even at low wages, are worthless to the dealer in this market. Such people are parasitic elements and the dealer who permits them to stay once he is certain that they are incorrigible, is paying them his money to hurt his own business.

## **Use Care in Donating**

As suggested in a previous issue of this magazine, the dealer should scan all donation requests—study them carefully, before going into them. Many donation and "advertising" enterprises are for worthy causes, or hold out certain value prospects for the dealer. On the other hand, there are countless others which are schemes, pure and simple, and which offer no advantages.

Every dealer in the country knows what it is to be "pestered" by requests for donations to this and to that, and most are familiar with the "blackmail" angle often employed—veiled suggestions that certain groups may boycott the dealer who doesn't "kick in."

Since there are so many requests to advertise in various booklets,

programs, etc., and so many requests for merchandise donations, the retailer must watch his step or he will go "over-board" before he knows it. The best rule to follow is the one dictated by the dealer's own common sense. If the proposition offered has advertising merit, the dealer is justified in going along with it, upon a cost basis which he feels may be profitable to him. But all schemes in the form of donations should be analyzed. It costs money to advertise in legitimate media, but these are time-proven investments. It costs money to go into questionable "advertising" also, and the results one can expect are seldom promising.

"Useless" free service under guarantee periods needs to be scrutinized too, and the retailer who is out to operate a sound business will do all in his power to prevent allocating his valuable time explaining things to customers after sales have been made.

This "useless" free service cannot be eliminated entirely from the retail business, but thorough pre-sale demonstration and making sure the customer receives all the manufacturer's instruction material, will help reduce its rate.

Certain customers will, in spite of all precautions the dealer takes, call upon him for more service and instruction than is needed, but the merchant can, as before stated, keep this down by doing his utmost to see that the user understands operation of the radio or appliance at the time the sale is made.

## **Watch Overhead Expenses**

There are often ways open to the dealer whereby he can cut such expenses as heating and lighting. For example, a time-clock operating the window lights, saves money and eliminates the dependence upon human beings to put out the lights when the store is locked up. Automatic controls on store heating devices often more than pay for themselves.

Then, too, the dealer can chop  
(Continued on page 117)



Detroit Retailer Louis Winn, waiting on customer, has thrown "lazy" sales methods out.

# Sells in

"This policy is especially important at our store. Many of our customers are among the most prominent people in this city. Included in our clientele are such people as educators, manufacturers, and other professional folk in the higher income brackets. These customers deserve—and get—careful attention."

Close customer relations have also given the store the benefits of word-of-mouth advertising. Friend-tell-friend publicity has brought much business to the establishment—and at no extra cost, also.



The store sees many freezer sales ahead.

## Radio Dealer Uses Topflight Salesmanship Now to be Ready for Coming Buyers' Market

● Consumers want new merchandise—they need receivers, refrigerators, washers, etc., badly. But, in spite of this, many customers will be careful as to where to spend their money, believes Louis Winn, owner of the Economical Radio & Appliance Co., 3409 Cass Ave., Detroit, Mich.

"Many times I've asked myself the question—how to get the most profits from selling radios and other goods, and I think I have the answer," this retailer states.

First, the firm is carrying lines of merchandise which already have complete public acceptance. The firm feels sure that a selling job becomes much easier when the products sold are nationally advertised and whose names are well-known.

In view of this, the store will

carry such well-known brands as Stromberg-Carlson, RCA, Frigidaire, GE, Wilcox-Gay, Bendix, etc.

Secondly, the store's proprietor has made up his mind to go after sales with plenty of energy. Lackadaisical selling methods have been thrown out.

"Some dealers may feel that vigorous sales techniques may not be necessary because of the huge pent-up demand for merchandise. I believe that customers will have to be sold just as they were before the war," Dealer Winn asserted.

Thirdly, the store will conduct its business on a friendly and personal basis. Maintaining close customer contact is one of the best ways which a retailer can use to boost his sales volume and build more prestige, says this merchant.

The combination of the three points mentioned is the surest way of getting the most profits from selling. In addition, these policies are made-to-order to stave off chain store competition, according to Dealer Winn.

The firm has the double barreled advantage of being located on a busy thoroughfare with a large amount of pedestrian and auto traffic. Its excellent location draws customers into the establishment, and once inside, the proprietor sees to it that every effort is made to induce them to buy.

Winn has accomplished this by

# Sellers' Market

selling radios and higher priced radio-phonograph combinations in warm and attractive surroundings. His radio salon provides a home-like atmosphere and is arranged to put the buyer completely at ease.

Soft carpeting on the floor of the radio salon, attractive bouquets of flowers, and pictures on the walls, all help to make buying here very pleasant. For the customer's comfort, easy chairs and settees are at his disposal.

Catering to the comfort of customers has already paid off handsomely in profits. The Freed-Eisemann line of radio-phonograph combinations is carried by the store, and in the past these sets have been sold in large quantities. The firm has been one of the largest dealers of this line in its trading area, and frequently has sold more of these receivers than larger stores throughout the country.

## Store in Public Eye

Constant advertising combined with attractive displays of available radios and electrical appliances has brought, and is bringing, large volume business to the store. "Keep your store in the public eye all the time," advises Winn.

The store's proprietor feels that the coming year will give radio-electrical dealers the greatest op-

portunity in their history to make large volume profits.

"This is the chance we radio retailers have long been waiting for," he said. "But we are also certain that the business will go only to those who go after it—and we are going after it with a great deal of vigor."

## "Go-Getter" Selling

The store's program for large profits from merchandising calls first for an aggressive advertising and publicity campaign designed to get people well acquainted with the establishment. "We want our customers to know us—and know us well," Winn said.

After purchasers are brought into the store, the firm will concentrate on the point of sale. According to the store's proprietor: "Here is where the sale is made or lost; here is where the customer decides to make the establishment 'his' store or shop around for another place in which to buy.

"Many customers have not as yet recovered from the harsh treatment they may have received from some dealers during the war. To get into



Tact and courtesy get priority at the store.

the good graces of these purchasers, it will be necessary to handle them with kid gloves.

"We intend to win the confidence of our customers," Winn continued, "by using the utmost tact and courtesy in our dealings. We'll avoid high pressure sales; we'll exercise care in selling our patrons 'up'."

To continue giving customer sat-

(Continued on page 117)

"To sell your customer, make her comfortable," says Winn.



# New Things in Radio

## Admiral RADIO & COMBO

Table model radio is encased in smartly styled plastic cabinet, and offers reception on broadcast and short-wave.



Radio-phonograph has automatic record changer. Radio tunes to broadcast



and short-wave bands. Admiral Corp., 3800 W. Cortland St., Chicago 47, Ill.—RADIO & Television RETAILING

## Flush Wall RADIO

Flush wall receiver, designed for kitchen and bathroom use. May be used



in other rooms as well. 5 tubes. Easily installed. Flush Wall Radio Co., Newark, N. J.—RADIO & Television RETAILING

## Stromberg-Carlson RADIO

The Newscaster is an ac-dc table radio featuring standard broadcast reception, an easy to read lighted dial, dynamic speaker, automatic volume control and tone control. Built-in loop antenna is present. Provision is made



for connection of an outside antenna. Stromberg-Carlson Co., Rochester 3, N. Y.—RADIO & Television RETAILING

## Stewart-Warner RADIOS



Model 9014-E is a 6-tube, 2-band ac-dc set in a plastic cabinet. 9001-C



is a straight ac table model, with 6 tubes and 2 bands, five pushbuttons and a 3-position tone control. Stewart-Warner, 1826 Diversey Parkway, Chicago 14, Ill.—RADIO & Television RETAILING

## Sonora RADIO & COMBO

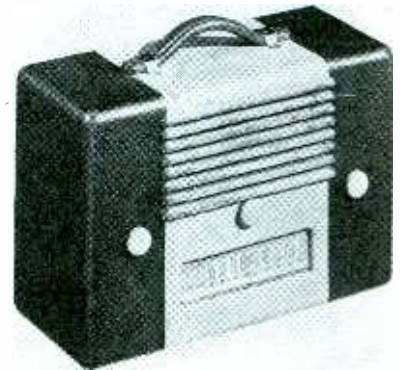

5-tube, 3-way portable radio, model RY-224. Works from self-contained batteries, 110 v ac, or 110 v dc. 5-in. dynamic speaker is used.

Model RHF-213 is a table-type combination. Has 5 tubes, works on ac. Radio tunes to 535-1,620 kc. Phonograph plays ten and twelve in. records with the lid closed. Latest type 78 rpm self-starting motor, with automatic



stop, is used. Sonora Radio & Television Corp., 325 North Hoyne Ave., Chicago 12, Ill.—RADIO & Television RETAILING

## Masco AMPLIFIER

De Luxe Hi-Fidelity Amplifier, designed for faithful reproduction of recorded music, FM and television. 25 watts output on all frequencies from 30 to 15,000 cps at less than 5% rms harmonic content. May also be used as a recording amplifier, matching low or high impedance cutting head. List price \$117.50. Mark Simpson Mfg. Co., 186-194 W. Fourth St., New York 14, N. Y.—RADIO & Television RETAILING

# Readied for Great Demand

## U. S. Television RADIO-PHONOGRAPHS

"Chambermusic" automatic phono-radio, model R3006. AC. Feather action automatic changer. Needle-book holder and used-needle cup are present.



Model R5002, "The Dumbarton," uses two double purpose tubes to offer 10-tube performance. Feather-action automatic record changer is used. Speaker is 12-in. For ac power supply. Modern

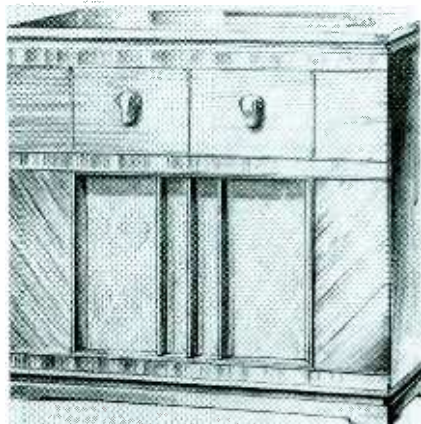

renaissance cabinet. U. S. Television Mfg. Corp., 106 Seventh Ave., New York City 11, N. Y.—RADIO & Television RETAILING

## Permo PHONO NEEDLES

Fidelitone Master has patented self-locking design, floating point construction, filtered record scratch, and horizontal and vertical shock absorption. Permo Inc., 6415 Ravenswood Ave., Chicago 26, Ill.—RADIO & Television RETAILING

## Arvin RADIO & COMBO

Model 541B is a 4-tube battery radio. Reception is on American band from 540 to 1,600 kc. Built-in loop antenna has connection for outdoor aerial. Speaker is 6-in. heavy-duty type. Dial has "off-on" indicator. 400-800 hour single pack 1½ v "A" and 90 v "B" battery is used. Set is adaptable for ac conversion unit.



558 is a 5-tube ac-dc radio, ac phonograph combination, table type. Two of the tubes are dual purpose. Broadcast coverage is American band, 540-1,600 kc. Phonograph plays 10 or 12-in.



records, changed manually. Speaker is 5-in. heavy-duty type. Noblitt-Sparks Industries, Inc., Columbus, Ind.—RADIO & Television RETAILING

## Sni-Dor Radioelectric EXTENSION SPEAKER



The Radiolink is an extension speaker which can be readily attached to any make of radio. It makes radio or phonograph reception possible in any room of the house. Volume control is present. A three-way switch arrangement makes it possible to operate the radio and Radiolink either simultaneously or independently of each other. Retailers for \$7.95. Sni-Dor Radioelectric Limited, 455 Craig St., West Montreal, Quebec—RADIO & Television RETAILING

## Crosley RADIO & COMBO

Table radio 66 TA receives on 2 complete bands, broadcast and overseas. 6 tubes give 4 watts undistorted output. Electrodynamic speaker, signal web an-



tenna and automatic sensitivity control are present.

56 TP is a table type combination



with a manual record player that plays ten or twelve in. records. 2-band reception: broadcast and overseas. 5 tubes, including beam power output. Cabinet is walnut veneer. The Crosley Corp., Cincinnati 25, Ohio—RADIO & Television RETAILING

(Continued on page 46)

# New Radio Merchandise

## Westinghouse RADIO & PHONO-RADIO

Camera type portable, 6 x 6 x 9 in. Has tuck-away handle for easy portability. Plastic sides and a metal center band. Available in pastel green and gold, and in gold and ivory.

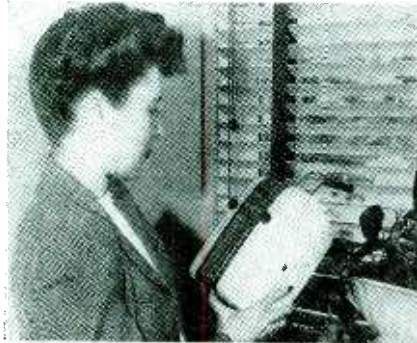

Table combination features "lift-out" radio, which can be removed at will for



use elsewhere as an independent radio set. Record player, under top-raising lid, will accommodate 12 10-in. or 10 12-in. records, and is fully automatic. Westinghouse Electric Corp., Home Radio Division, Sunbury, Pa.—RADIO & Television RETAILING

## Ansley RADIO-PHONOGRAPHS

The Salem is a combination in American Colonial style, made in pine with a mellow brown finish to match the finest American antiques. Model 53, 54 or 63 chassis has automatic record changing Dynaphone. Size of set is 34-in. high, 39-in. wide, and 19-in. deep.

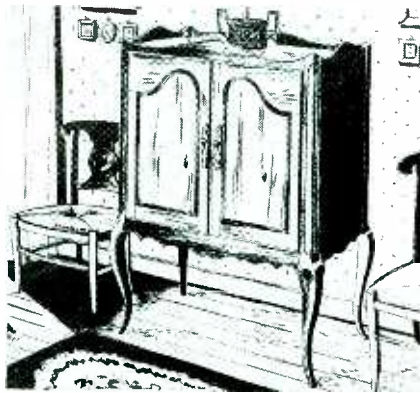
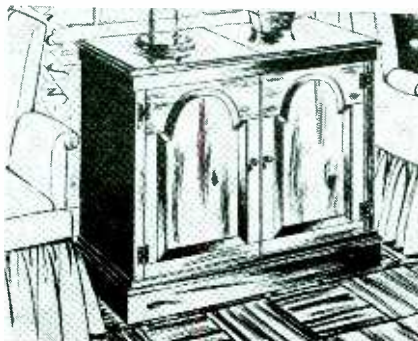

The Normandy is French Provincial in style. Proposed finish is a natural walnut color which shows off the beautiful grain of the wood to best advantage. Size is 50 in. high, 33 in. wide, and 20 in. deep. Model 53, 54 or 63 chassis has automatic record-changing Dynaphone. Ansley Radio Corporation, 41 St. Joes Ave., Trenton 9, N. J.—RADIO & Television RETAILING

## Northeastern Engineering RADIO

5-tube superhet with heavy duty speaker. Dial is of edge lighted plexiglas and the cabinet is unbreakable



steel. This steel case will be finished in a variety of colors and novelty effects, including hammered and wrinkle finishes. Northeastern Engineering, Inc., Manchester, New Hampshire—RADIO & Television RETAILING

## Regal RADIO

6-tube ac-dc superhet, with 6-color illuminated dial. Has sensitivity of 5 microvolts. OPA-approved list price is



\$32.95. Set is now in production. Regal Electronics Corp., 20 West 20th Street, New York City, N. Y.—RADIO & Television RETAILING

## Temple RADIO

Table model, E-512. One band, 535 to 1700 kc. Two watt output, permanent magnet speaker, 105-125 volt, ac-dc operation. Slide rule dial with pointer travel. Self-contained loop. High sensitivity. Lists at approximately \$30.



## Temple RADIO

Table model radio-phonograph, model E-511. Single band radio, 535 to 1700 kc. Manual record player. Two watt output, permanent magnet speaker. Long slide rule dial; self-contained loop; high sensitivity. Lists at approximately \$50. Templetone Radio Mfg. Corp., New London, Conn.—RADIO & Television RETAILING

## Elec-Toy ELECTRICAL TOYS

4 varieties available. The toy electric cannon propels wooden shells with pop-gun force by electrical contact made by pressing a small switch. The wooden shells project from the movable muzzle, which recoils like a real cannon.

The Black Light Kit enables users to paint with fluorescent paints under a black light. When the black light hits the surface of the drawings colored with fluorescent paints, the surfaces light up and glow brilliantly in whatever color has been used.

The two other toys consist of a 2-way inter-communication set called the Utiliphone, and an electronic ten-pin game called Buzz-Ball. Elec-Toy, Electronic Laboratories, Inc., 8 South Dearborn St., Chicago 3, Ill.—RADIO & Television RETAILING



# Exciting; Profit - Promising

## ECA RADIO & PHONO-RADIO

Model 101 is a 5-tube ac-dc table radio. Features include 5-in. speaker, built-in loop antenna, and Di-fusa-tone grill for equalized sound diffusion. Cabinet is hand-rubbed wood of functional design.



Model 104 is a 5-tube table combination. Operation of record-player is manual. Undistorted power output is one watt. Speaker is 5-in. Built-in loop

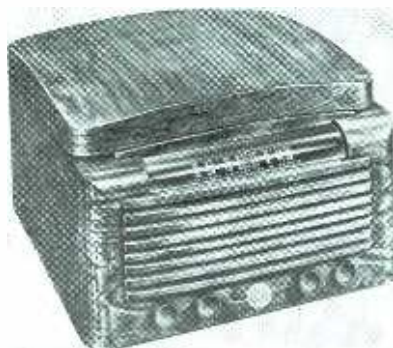

antenna is present. Electronic Corp. of America, 45 West 18th Street, New York City 11, N. Y.—RADIO & Television RETAILING

## Triplett TUBE TESTER

Model 2413 provides for emission test, short and open element test, and trans-conductance (mutual conductance)



comparison test for matching tubes. An additional element switch and spare socket are present, to provide for possible new-type tubes. Book-type tube chart is carried in lid of tester. Additional tube data can be easily added. Three position lever switching makes for great flexibility. Triplett Electrical Instrument Co., Bluffton, Ohio—RADIO & Television RETAILING

## Sentinel RADIOS

284-W is a 5-tube, ac-dc superhet. Broadcast band is 530-1,730 kc. Features include built-in loop aerial, 5-in. pm speaker, and iron core i.f. transformers. Cabinet is walnut bakelite, streamlined style.



284-I is similar, but has an ivory bakelite cabinet. Sentinel Radio Corp., 2020 Ridge Ave., Evanston, Ill.—RADIO & Television RETAILING

## Lake PHONOGRAPH CASE

For portable phonographs. Brown leatherette covering. Inside dimensions 17 in. long, 14 in. wide, 8½ in. high.



Has blank motor board and opening for speaker. Priced at \$8.95. Lake Radio Sales Co., 615 W. Randolph St., Chicago 6, Ill.—RADIO & Television RETAILING

## Teletone RADIOS

Model 103 is an ac-dc superhet featuring a built-in aerial, no. 5 Alnico pm speaker, and a full-vision slide rule



dial. Walnut veneer. Model 109 is similar, but comes in a 2-tone plastic case. Teletone Radio Co., 609 W. 51st Street, New York City, N. Y.—RADIO & Television RETAILING

## Garod RADIO

Farm console, model 6FS2. 1,000 hour farm battery pack included. 6 tubes. Receiver can be easily adapted for use on ac or dc current. Large auditorium speaker and concealed loop antenna are present. Garod Radio Corp., 70 Washington Street, Brooklyn 1, N. Y.—RADIO & Television RETAILING



(Continued on page 48)

# New Money-Making Radios

## Philco RADIO & COMBO

Model 420 Ivory is an ac-dc table radio featuring an illuminated radial dial for easy tuning, noise-reducing r.f. amplifier stage, and a large oval electrodynamic speaker.



Model 1201 is a table radio-phonograph. Record player is automatic. When record is placed in slot and door is closed, the record is played. Unit stops itself, and adjusts automatically to ten and twelve inch records. Single



accessible knob switches to radio or phono and controls volume on each. Remaining control is for radio tuning. Philco Corp., Tioga & C Sts., Phila. 34. Pa.—RADIO & Television RETAILING

## Sonata MICROPHONE

Intended for home entertainment, and attachable to any radio set without extra wiring. Constructed of metal. 4 1/4 in. high, 3 in. in diameter. Comes complete with cord and push button switch for cutting in and out. List price \$1. Sonata Products Co., 624 S. Michigan Ave., Chicago 5, Ill.—RADIO & Television RETAILING

## Motorola RADIOS

Model 75T31 is a 3-band table set with 6 push-buttons. FM, broadcast and short-wave reception. Cabinet is walnut veneer. Dimensions: 20 3/4-in. wide, 11-in. high, and 12 3/4-in. deep.



5A1, the "Playboy", is a battery-operated personal set. Aero-vane loop. Weighs 4 1/8 lbs. Dimensions are 6 1/4 x 4 5/8 x 3 1/2 inches. Galvin Mfg. Corp., 4545 Augusta Blvd., Chicago 51, Ill.—RADIO & Television RETAILING

## DeWald RADIOS

A504 Excel is an ac-dc superhet offering American and foreign reception.



Output is beam power. Large dynamic speaker is present. Available in mahogany or ivory finish.



Model A-500 is similar. Standard American broadcast and police reception. Dial is slide-rule, easy-vision tilt-top with high ratio Vernier tuning. Set is available in figured walnut or antique ivory. DeWald Radio Mfg. Corp., 440 Lafayette St., New York City 3, N. Y.—RADIO & Television RETAILING

## Symphonic RECORD-PLAYERS

Models 3TPC and 3TPW have 3-tube amplifiers. Power output is 3 1/2 watts.



# Designed for Modern Market

Scratch filter network is present. Speaker is 6½-in. pm type. 10 or 12-in. records may be played with the cover closed. Model 3TPC is portable. Both models now in production. Symphonic Radio & Electronic Corp., 258 Park Square Bldg., Boston, Mass.—RADIO & Television RETAILING

## GE RADIO & COMBO

Model 101 is a 5-tube superhet ac-dc table radio, offering reception on the standard broadcast band. Ivory finish with multi-weave grill. Dimensions are 12 x 7½ x 7¼ inches. Also available in brown finish (model 100).



106 is a 5-tube ac table model radio-phonograph. Standard broadcast reception. Speaker is 6½-in. Alnico 5. Placing tone arm on record starts phono motor; replacing arm on its rest stops the motor. Permanent sapphire needle is used. General Electric Co., Bridgeport, Conn.—RADIO & Television RETAILING

## Ultratone PHONOGRAPHS

Model TA-6 is a closed top automatic record player. Plays and changes twelve 10-in. or ten 12-in. records with the lid closed. Separate on-off switch for motor and amplifier is present. Over-

size pm speaker. Selected and matched walnut cabinet.

Model PA-6 is a carryabout portable automatic record changer. Speaker is

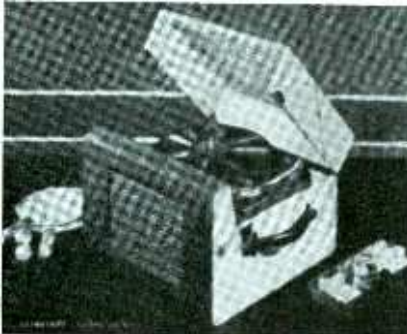

heavy-duty pm type. Cabinet size is 15 x 15 x 10 inches. Audio Industries, Michigan City, Ind.—RADIO & Television RETAILING

## DuMont TELESET

This deluxe model provides a large clear picture 18 x 13½ inches. Flame grain mahogany cabinet houses the television unit, as well as AM, FM, and



short wave radio, record player and changer, home recording facilities, and, in some models, album space. Allen B. DuMont Laboratories, Inc., 2 Main Ave., Passaic, N. J.—RADIO & Television RETAILING

## Garod RADIOS

Model 5D1 (standard) is a 5-tube portable radio, operating on battery, ac and dc. 5D2 is the de luxe model.



Garod Radio Corp., 70 Washington St., Brooklyn 1, N. Y.—RADIO & Television RETAILING

## Medco RADIO

6-tube ac-dc superhet. American band, including police calls. Speaker is pm type, Alnico no. 5. Plastic cabinet, in



black and walnut. Built-in loop antenna. Medco Mfg. Co., 5 West 45th Street, N. Y., N. Y.—RADIO & Television RETAILING

FOR LATEST ELECTRICAL

APPLIANCES

SEE PP. 70, 71, 72, 73

# Cashing in



Above, M. K. Lock, owner, at recording amplifier controls. This retailer designed much of the equipment used here. Broadcast station atmosphere appeals to customers. Upper right, patrons make a recording. At mike is Frank Grasso, music director of station WFLA. Lower right, operator Blanche Weston cuts a disc. There's money in the business, Lock finds.

## Florida Radio Dealer Finds Large Market for Discs; Tells How He Goes After Business

● Offering a wide range of recording services to the public is paying off in profits to M. K. Lock, proprietor of the Lock Radio Co., 506 Florida Ave., Tampa, Fla.

"We are offering the public not just another recording service, but a professional disc-cutting service complete in every detail. And, judging from our results, the public likes the idea," Dealer Lock said.

### Studio Draws Sales

The firm's recording studio is equipped with the latest apparatus, and bears a striking resemblance to a broadcasting studio. Not only does the company's studio look like a broadcasting station, but the procedure for making a record follows

very closely the technique of radio broadcasting.

Customers coming here to make transcriptions are immediately impressed with the professional appearance of the services which Lock is ready to offer. In addition to recording at the studio, the firm will also cut discs "on location," using its mobile equipment.

Lock's recording studio was opened in June of this year, and immediately made a hit with the residents of this community. "There was a need for the type of recording facilities which we offered which may account for the cordial reception we received from the public," this retailer stated.

"However," Lock continued "the idea of establishing a studio for

personal and professional recording did not come to us by accident."

"Early this year, we were threshing around wondering how to solve the problem of establishing a store in the busy downtown section which would prepare us for future radio merchandising activities. At that time, the prospects for receiving new radios in the near future did not look very good.

"A description of a recording studio launched by a dealer in the West, published in *RADIO & Television RETAILING*, was the germ which brought about the development of our recording studios. This article suggested the solution to our problem."

When the recording studio was first established, all that was ex-

# on DeLuxe Recording

pected from it was sufficient income to pay the overhead and carry the firm along until new radios were again available. Thus the company hoped to be all set up and ready to go when radio selling began. Lock's results are beginning to prove that he was more than on the right track in his decision.

Now that some new receivers and electrical appliances are being received by the firm, this dealer finds that recording is *more* than a sideline. The EXTRA PROFIT from transcribing is being counted upon to boost the firm's sales volume to new peaks.

## Customers Like Layout

The company's recording business is aimed to give customers a highly professional record cutting service. The attractive studio and efficient layout impresses patrons with the quality of work done here.

Customers coming to the store are directed to a specially designed, soundproofed room. When the patron is ready for recording, he faces a regular broadcast "mike." The operating technician's voice, giving last minute instructions, comes from a speaker built into the studio wall.

When a colored signal light blinks "On," the customer starts to record. A specially designed clock-like meter begins to mark off seconds as the recording proceeds. As the record nears its completion, the clock-like indicator warns the customer to speak faster. When the disc is completely cut, a red light flashes on, and the voice of the operator tells the patron that the record is finished.

A minute later, while the customer is still in the recording room, he hears his recorded voice as the disc is played for his approval.

## Many Sources of Profit

Prospective recording customers coming to the studio are told that only high quality records are made here. They are informed that the acoustically-designed studio, broadcast microphones, and high fidelity amplifiers assure patrons of professional quality, whether their requirements call for a record for

broadcasting purposes, or merely for private use.

The service offered by Lock is wide in scope. "Some radio-electrical appliance dealers who do recording are not aware of the many sources through which profits can be made from cutting records," declares this merchant.

"We go after transcription business in many different ways. We

Prospective purchasers are advised that instantaneous recordings are made for all purposes:

For children—A "voices of memory" record. To recall that childish treble when they are "grownups."

For those away from home—A "Voco-Message" record. The *personalized* way of sending greetings.

For students of music or elocution

(Continued on page 120)



get income from social organizations, civic groups, business and industrial organizations, students, and other individuals.

"Also the customers we have now, will prove to be hot prospects for radio and radio-phonograph combinations sales later on. Recording helps us to keep active contact with the public."

Newspaper advertising is used to tap the recording market. Direct mail is also employed to build sales volume. Leaflets describing the various services offered are sent through the mail to bring in new business.

Selling points used by the firm to attract customers are as follows.



# Store to Draw More Record

***That's What This Bay State Dealer Wanted—And Here's How***

● Radio, electrical appliance, and record stores will need lots of "elbow room" in which to display and sell the new merchandise now rolling off assembly lines, according to Carl Vineglass and Alexander Weiner, co-proprietors of Al's Radio & Furniture Co., 520 Essex St., Lawrence, Mass.

To cash in on the tremendous demand for new goods, these dealers have moved into new quarters which now occupies eight times more space than they had at their previous location.

With merchandise beginning to

move into the spacious store, the firm is "priming" its organization for high volume selling. Not only have these retailers moved into roomier surroundings, but they have also modernized their present establishment inside and outside.

The store's main floor and basement, each measuring 32 feet by 80 feet, have been streamlined for profit-making. In order to be "certain" that sales come to this establishment "in bunches," Dealers Vineglass and Weiner have split the store into "triple departments," for records, radio, and appliances.

To make sure that plenty of profits are "on tap," the three "triple feature departments" have been groomed for large volume business. This means smart styling, displays that pull, and an aggressive merchandising program.

With one eye on a "record" record business, and the other on large profits from radio-phonograph combination sales, the organization has given the record department lots of sales appeal.

Four modern disc-listening stations have been built in which customers can hear the latest record-

Owners of Lawrence, Mass., store believe there's magic in the word "Television" so they display it prominently in new "service bar" which cost \$1,000.



# Sales!

## He Got It

ings in comfort. Three of the booths are devoted to swing addicts, while the fourth is reserved exclusively for lovers of "long-haired" music.

Classical music fans are usually high profit customers, and the proprietors of the store feel that these customers deserve some extra attention. It was with this view in mind that a sign was placed on the "classical booth" reading, "Reserved for Classical Records."

For use during the time when the record booths are tied up, three additional listening posts are available. However, these record stations have earphone devices attached to each record player which permit customers to listen to discs without disturbing other purchasers.

This arrangement is working out very well, the store finds. Record salespeople feel it is easier to sell a customer an expensive album when they are not disturbed by patrons using record players which are not inside listening booths.

### 10,000 Albums Stocked

A large selection of records aimed at various musical tastes is available here. About 10,000 albums are in stock plus an abundant selection of single discs. One of the racks on display is capable of holding great numbers of records.

Four saleswomen are engaged in selling the leading brands of platters, which indicates the "whopping-size" business done in this department.

Children's albums are being actively pushed, and revenue from these discs is boosting the volume. Among the brands sold are such leading names as Decca, Victor, Majestic, Capitol, Columbia, etc.

Retailers Vineglass and Weiner are out to "squeeze" as much profits as possible from the sale of radios and radio-phonograph combina-



Four saleswomen keep busy in this modern record section. Special facilities are provided for customers of classic, popular and juvenile discs. Radio-Combinations will be actively merchandised.

tions. To spotlight the new receivers, the co-owners have placed the radio department well up towards the front of store near entrance.

An advantage in placing radio merchandise in this position is that the goods can be easily seen from the street through the attractive all glass doors. The firm has stated that it will buckle down to promot-

ing the sale of sets by using intelligent "displaymanship."

Near the front doors, an eye-appealing, sales-building circular display fixture has been placed which can "show off" from 110 to 125 table model radios.

Built at a cost of about \$400, the display is designed to be an active

*(Continued on page 117)*

Night and day, large signs attract new customers to Al's Radio & Furniture Co., on one of the city's main streets. Modern glass doors and ample show windows are of eye-catching design.





A courteous clerk means a satisfied customer.

# DISC SELLING

**Personnel Plays a Big Part in Successful Record Sales. Choose and Train Help Carefully. Get Ready Now for Fast-Moving Market**

• Every retailer knows that his store organization is no stronger than its weakest link. Alert record merchants are as thoughtful in employing disc salesmen and saleswomen as they are about their whole buying setup.

Even with the assistance of "self-service" methods, which helped many a retailer over the bad spots during the personnel shortage days of the war, records must be merchandised to the customer.

## **"Don'ts" on "Temperamentals"**

It is not at all necessary for a sales individual in the record department to be a musician, nor is it necessary that he or she have a "musical background".

Customers want what they want, not what an individually developed taste in someone else dictates. And, since the more highly educated

musicians and music lovers almost invariably are partial to certain composers, types of music, and types of instruments, there is always the danger that they may try to influence the customer unduly in his way of thinking.

Knowledge of stock is more important. And knowing stock takes time and patient application of the sales person's best efforts.

## **"Know How" on Stock**

The location of all stock and the reasons for its several allocations are vital for a selling individual to know. Various methods are followed by different merchants, and there are many good systems.

But taking the clerk carefully through the details of all stock arrangement, instructing him thoroughly on your set-up and the reasons behind the arrangements, will help him immeasurably toward de-

veloping into a top-flight worker.

If personnel is given the responsibility of their jobs, and understand them thoroughly, the result is usually a willing worker and a worker with his mind on his job, thinking definitely toward improvements and streamlined methods that result in more sales.

## **Pleasant Approach**

Persons happy in their work are usually those who have their jobs well in hand, know which way they are headed, and getting results. And persons happy in their daily routines are most likely to present a pleasant attitude toward your customers.

This pleasant attitude on the part of your clerks is one of the most important factors in your selling methods in any department of your establishment. But it is especially important in your record section because it is the one department in your store where sales can be unlimited.

## **That Elusive "Buying-Mood"!**

Record-buying on the part of your customers can be largely a matter of mood in many instances. The customer's buying mood in this department can be very easily destroyed by an unpleasant, disinterested approach on the part of a sales person.

On the other hand, a helpful attitude, attentive to the customer's desires and wishes in the field of recorded music, can do much to expand the imagination, and almost directly the volume of the sale.

## **Field Unlimited**

With all the excellent use of colorful album covers, display pieces, and other manufacturer's sales aids, record clerks should be made to realize the value of interrelated selling in discs. Give the customer half a chance, and he'll almost sell himself on buying more and more records, if he is properly handled by your sales person. But that sales person must be carefully led by you, originally, into the know-how of selling discs in your store.

Records, while not selling at "luxury" prices, are nevertheless a luxury item, inasmuch as the customer doesn't have to have them. They don't come under the heading of food, warmth, clothes or shelter. But they are something he would like to have. If properly led, he'll buy them!





It's going to be a  
Decca Christmas for all!

... and especially for you, Mr. Decca Dealer, when 30,000,000 people read this powerful, four color ad in their Sunday papers. The ad invites them to take their Christmas lists to your store—gives them a happy solution to their gift problems. They'll be in to see you soon. Be sure you have enough Decca Albums and Records in stock to meet the demand.

**Featured  
In December**

- BING CROSBY—Merry Christmas**  
No. A-403 . . . \$3.25
- A Christmas Carol—**  
with **RONALD COLMAN**  
No. DA-290 . . . \$3.50
- The Littlest Angel—**  
with **LORETTA YOUNG**  
No. DA-399 . . . \$2.75
- Mr. Pickwick's Christmas—**  
with **CHARLES LAUGHTON**  
No. DA-379 . . . \$2.50
- A Christmas Gift—**  
with **JOHN NESBITT**  
No. DA-357 . . . \$2.00
- The Selfish Giant—**  
Starring **FREDRIC MARCH**  
No. DA-389 . . . \$2.00
- 'Twas The Night Before Christmas**  
—with **FRED WARING**  
and his **Pennsylvanians**  
No. A-350 . . . \$2.50
- Snow White And The  
Seven Dwarfs—**  
No. A-368 . . . \$3.50
- The Snow Goose—**  
with **HERBERT MARSHALL**  
No. DA-386 . . . \$3.50
- Alice In Wonderland—**  
**GINGER ROGERS** as Alice  
No. DA-376 . . . \$3.50
- Cinderella—**with **EDNA BEST**  
No. DA-391 . . . \$2.75
- (Prices do not include federal, state or local taxes)

**"A Decca Christmas to all..."**

Give your friends the joyous voice of Christmas... on Decca records. Songs and stories you love... recorded the way you like... the Decca way that lets you hear every word clearly. Take your Christmas list to your record dealer's. Choose the right Decca album or record for every one on it. And don't forget yourself!

**Gift Record Suggestions**

<b>WHITE CHRISTMAS</b> A LA 14132 No. 25576 . . . \$1.00	<b>THE FIRST WINTER</b> <b>CHERRY BLOSSOM OF THE VAGABOND</b> Dinah Shore and Lang Canyon . . . \$0.50 No. 18629 . . . \$0.50	<b>THE HOLIDAY CHRISTMAS STORY</b> (12 SONGS) <b>THE STORY OF THE THREE WISE MEN</b> (12 SONGS) as told by Charles Laughton No. 25565 . . . \$1.00
<b>THE LITTLEST ANGEL</b> Delicate, modern Christmas story told by Loretta Young, with choir. 6 sides, 10 inch. No. DA-399 . . . \$2.75	<b>THE SNOW GOOSE</b> Paul Gallico's stirring epic of the men at Durdurk, with Herbert Marshall. 8 sides, 12 inch. No. DA-386 . . . \$3.50	<b>THE HOLIDAY WALK</b> The Royal Canadian Mounted Police . . . \$0.50 No. 18717 . . . \$0.50
<b>THE SELFISH GIANT</b> Fairy tale for all ages, starring Fredric March. 4 sides, 10 inch. No. DA-389 . . . \$2.00	<b>THE RICKLE BEFORE CHRISTMAS</b> The whole Waring gang in Christmas classic. 8 sides, 10 inch. No. A-350 . . . \$2.50	<b>THE DUTY OF THE YEAR</b> Dick Tracy's story with Kim Darby, George and Yvonne Young and Genevieve Stebbins . . . \$0.50 No. 18714 . . . \$0.50
<b>THE WITNESS</b> PAUL HENREID HEAD TO HEAD	<b>ALICE IN WONDERLAND</b> Ginger Rogers as Alice, takes you gaily through the beloved whimsy of Lewis Carroll. 12 inch. No. DA-376 . . . \$3.50	
<b>THE SNOW GOOSE</b> Paul Gallico's stirring epic of the men at Durdurk, with Herbert Marshall. 8 sides, 12 inch. No. DA-386 . . . \$3.50		
<b>THE SNOW GOOSE</b> Paul Gallico's stirring epic of the men at Durdurk, with Herbert Marshall. 8 sides, 12 inch. No. DA-386 . . . \$3.50		

**and to all a good night!**

**DECCA RECORDS**  
"Decca" Reg. U.S. Pat. Off.

Copyright 1945, Decca Records, Inc.



**DECCA DISTRIBUTING CORPORATION**  
Executive Offices—50 West 57th St., New York 19, N. Y.  
In Canada—The Compo Company, Ltd., 131-41 18th Ave., Lachine, Montreal

# Variety in Discs High

**Plenty of Sales Ahead for Record Merchandisers. Manufacturers Bring Color and Quality to Many New Waxings to Catch Your Customers' "Buying Fancy."**

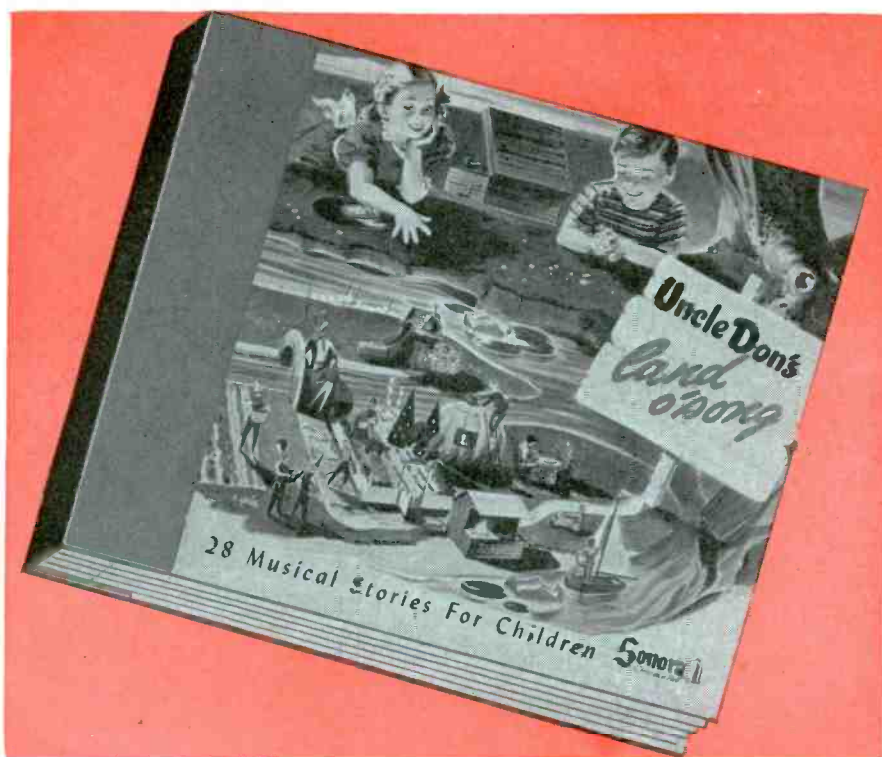

Sonora's new album for the children, "Land O' Song", a supplement to its very successful forerunner, the "Playland" album.

Disc manufacturers herald a bright New Year with plenty of fanfare in bright in-store sales aids, telling about the wide variety of new pressings.

Decca rings the bell with its platter combining those two top-ranking funsters, Bing Crosby and Bob Hope, in Put It There, Pal, backed by the Road to Morocco. Promotion features 8" x 10" easel-backed counter card in red, black and yellow, together with a 2-column newspaper mat duplicating the counter card picture. Nationwide in their appeal, Bing and Bob once again

Willis Music Co. in Cincinnati goes all-out in a window display for Decca's "Porgy & Bess" and "Oklahoma" albums.

are ranked with the "tops" in various cross-country radio popularity polls. Decca's second installment of Oklahoma will also be available this month.

Sonora's All Around the Christmas Tree, played by Mark Warnow and sung by Dick Todd, new Hit Parade headliner, will be delivered to dealers in a carton designed for counter display.

Majestic Records has signed Joe E. Lewis, who has been appearing at a New York famous nightery, Copacabana. One of his first numbers: Please, Mr. Truman, Play Piano For Me. Popular Louis Prima has just signed a new, long-term contract to record exclusively for Majestic.

Columbia stars Pearl Bailey in Tired and Fifteen Years, with orchestra under the direction of Mitchell Ayres. Les Brown is a favorite on The Last Time I Saw You and Gene Autry sings Don't Live A Lie. Woody Herman gives with the sentimental on his Gee, It's Good to Hold You disc.



# lights the New Year



Columbia's Frankie Carle continues as one of its best selling artists. This display is in the window of Francis Music Shop, Lakewood, Ohio. His personal appearances pack 'em in and make the cash register ring.

Asch offers a new album, *Jazz at the Philharmonic*, featuring many colorful artists including Willie Smith, alto-sax, and Chicago Flash on the drums! Albums *Struggle* (wild westerns), and *The Private Life of Adam and Eve* (drama with musical accompaniment) suggest wide variety.

Musicraft's new expansion brings Georgie Auld and his band to its platters in such numbers as *Sittin' and Rockin'* and *Air Mail Special*. It will also offer the Phil Moore Four on an exclusive basis.

Unique in children's discs is Cosmo Records' *Tubby the Tuba*, 2-platter album, which is musical instruction in instruments for kid-

One of the colorful series of Victor's new albums for children. There are many in its new line.

dies. Don't overlook this really new approach to children's listening on records! Cosmo also has Susan Reed, sweet southern folksong singer. And, Cosmo's Barry Wood has cut his version of *Tomorrow Is Forever*, title tune of the new International film. Cosmo will tie-in for a promotional campaign.

Victor's new line of records for children of all ages is extensive and a really important series for more sales. For youngsters from infancy to 12 years and over, these sets are designed to entertain through colorful pictures and text accompanying discs. Exceptionally beautiful in both sight and sound, these new albums comprise a children's library in themselves. Don't miss them!

Betty Hutton (*The Incendiary Blonde!*) does a new one for *Capitol*, *Doctor, Lawyer, Indian Chief*, from her new picture *The Stork Club*, scheduled for Christmas play-dates.

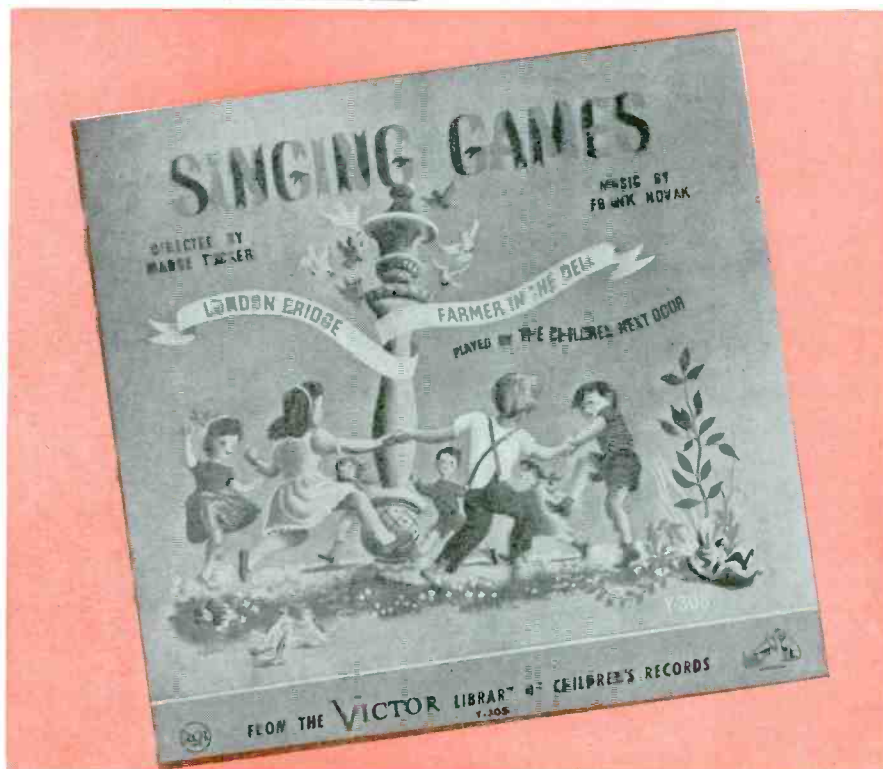

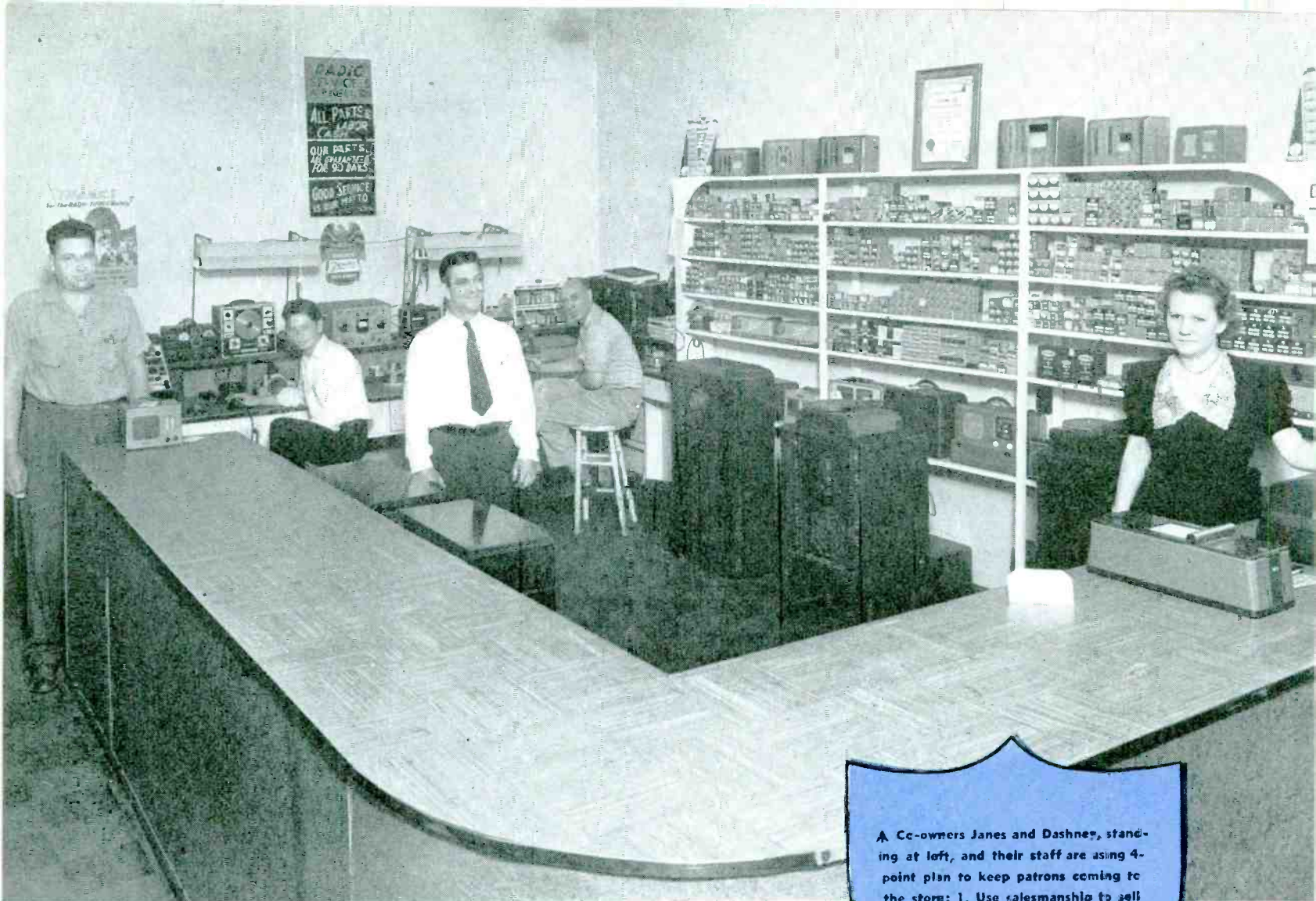

A Co-owners Janes and Dashner, standing at left, and their staff are using 4-point plan to keep patrons coming to the store: 1. Use salesmanship to sell service; 2. Give speedy and expert maintenance; 3. Have aggressive advertising policy; 4. Dealers are active in community; ▼ Staff stands for "Inspection".



# Service Builds Profits

## Missouri Sales and Maintenance Dealers Use Business-Like Selling Techniques to Guarantee Present and Future Income

● Don Janes and Henry Dashney, co-owners of a modern radio sales and service store at 402 Elm St., Springfield, Mo., are men who believe in the future of their business. Expansions during the war, expansions which are now being continued, reflect the aggressive spirit of these service dealers.

"The radio technician who treats his work as an art, who works on sets skilfully, has well-equipped service benches, capable assistants, and publicizes his business intelligently, will get constant profit, and find that expansion will take care of itself," said Henry Dashney.

An example of the business-like methods these technicians follow is the separate drive-in station for auto radio customers.

Home and car receivers were flooding into the neat service establishment some time ago at such a high rate, that it became necessary to arrange new facilities to take care of car sets only.

### Departments Speed Work

Dividing the maintenance work into two departments, home sets and auto receivers, has speeded repairs on both types of radios. At the present time, Janes is in charge of auto radio while Dashney specializes in home sets.

Service work in quantity is done at the store but at no sacrifice to quality. Despite the wartime boom in maintenance, which at the season's peak reached about 350 sets a month, there has been no slackening in the quality of work offered.

A two-day service is still furnished, and the store continues to clean and polish radio cabinets until they shine, before they are returned to customers; a pick-up and delivery service is being maintained for the convenience of patrons.

Rural dwellers furnish the establishment with a substantial number of receivers in need of service. To accommodate farmers living in outlying counties, who are often too busy with crops to come into town, a special service by mail is supplied. Special mailing boxes are provided

for the country folk sending in radios.

Farmers are going to be large volume purchasers of new sets, and the co-owners are doing everything possible to get into the good graces of the farming population.

Ingenuity provided the solution when the co-owners were faced with a serious shortage of skilled technicians. In cooperation with the local school authorities, the firm "recruited" the youth of this community for assistance.

The benefits derived from hiring these part time workers have been two-fold. First, the dealers have helped to relieve the shortage of servicemen. Secondly, the firm has developed some skilled radio service technicians to care for the community's receivers.

In the city's forward-looking school system, these youngsters receive technical and laboratory instruction in radio, and those showing promise are given apprentice positions in the Janes-Dashney store. A chance to earn a permanent position with the firm is offered the youths.

These young men are assets to the radio service field, according to the co-proprietors. The dealers devote a considerable portion of their time to answering the apprentices' questions and giving them lessons in correctly diagnosing and servicing receiver troubles.

### Veterans Come First

Business has been booming at the store, but Janes and Dashney give first preference on radio maintenance to World War II veterans who are patients at Springfield's O'Reilly General Hospital.

"Emergency" one-day service is given to receivers belonging to hospitalized war vets, and the store's technicians have strict orders to drop all work and give these sets priority. Veterans first, say these dealers.

A Hobby Shop is maintained at the hospital for making minor radio repairs. Operated by the vet-

erans themselves, the Hobby Shop is part of the prescribed treatment for some patients. Vets servicing sets at the hospital are assisted by Don Janes and Henry Dashney.

The classified section of the telephone directory is valued highly by the owners of the store as an advertising medium. An ad in the last edition of the book brought three new customers to the establishment on the day the directory was published. Each customer said that the ad was the thing that brought him in.

### Build Prospect List

Direct mail is also used. Every customer who brings in a set for servicing has his name filed. This list will be used as a mailing list to build more business.

To get sufficient room in which to sell new merchandise, the store next door has already been leased. Servicing will be continued "on a big scale" at the present establishment, according to Janes and Dashney.

Until sufficient stocks of merchandise arrive, however, the firm is continuing to rely on maintenance, record merchandising, and the sale of used sets for profits.

The sale of second-hand radios has been lucrative for these dealers. Each month about 25 receivers are completely reconditioned and resold. This additional source of income is helping to keep the firm's sales volume high.

A record section has been installed in the store and business from this department has been brisk. A short distance from the establishment is a high school teeming with record prospects, which accounts for the success of the disc section.

Record sales have been so good that this branch of the business will be expanded in the near future. Plans call for the construction of modern listening booths, attractive displays, and the use of profit-building sales methods.

"We've been laying the ground-

(Continued on page 112)

# Products of RADIO & TELEVISION Manufacturers

Listing the companies whose lines cover one or more of the six groups of greatest importance to retailers and distributors.

The following manufacturers of radio receivers have returned our editorial questionnaire giving the information needed for these listings:

	Home AM-FM	Combinations	Television	Auto Radio	Amateur	Commercial*
Admiral Corp., 3800 W. Cortland St., Chicago, Ill.	•	•	•	•	•	•
Air Communications Co., 2233 Grand Ave., Kansas City, Mo.	•	•	•	•	•	•
Aircon Corp., Fairfax & Funston Rds., Kansas City, Kan.	•	•	•	•	•	•
Air King Prod. Co., Inc., 1523 63rd St., Brooklyn, N. Y.	•	•	•	•	•	•
Airplane & Marine Instruments, Clearfield, Pa.	•	•	•	•	•	•
American Communications Co., 306 Broadway, New York, N. Y.	•	•	•	•	•	•
Andras Radio Corp., 43-20 34th St., Long Island City, N. Y.	•	•	•	•	•	•
Anslay Radio Corp., 21-10 49th Ave., Long Island City, N. Y.	•	•	•	•	•	•
ARF Products, 7713 Lake St., River Forest, Ill.	•	•	•	•	•	•
Autoerat Radio Co., 3855 N. Hamilton Ave., Chicago	•	•	•	•	•	•
Automatic Radio Mfg. Co., Inc., 122 Brookline Ave., Boston	•	•	•	•	•	•
Aviola Radio Corp., 703 Ivy St., Glendale, Calif.	•	•	•	•	•	•
Bell Radio Co., 125 E. 46th St., New York, N. Y.	•	•	•	•	•	•
Belmont Radio Corp., 5921 W. Dickens Ave., Chicago, Ill.	•	•	•	•	•	•
Bendix Radio, Div. of Bendix Aviation Corp., Baltimore, Md.	•	•	•	•	•	•
Browning Laboratories, Inc., 750 Main St., Winchester, Mass.	•	•	•	•	•	•
Collins Radio Co., 2920 First Ave., Cedar Rapids, Iowa	•	•	•	•	•	•
Colonial Radio Corp., 254 Rano St., Buffalo, N. Y.	•	•	•	•	•	•
Columbia Electronic, Inc., 185 E. 122nd St., New York, N. Y.	•	•	•	•	•	•
Communications Co., Inc., 300 Groco Ave., Coral Gables, Fla.	•	•	•	•	•	•
Communications Equip. Co., 523 W. 6th St., Los Angeles	•	•	•	•	•	•
Concert Master Rad. & Tel. Co., 1800 Winneamac Ave., Chicago	•	•	•	•	•	•
Concord Radio Corp., 901 W. Jackson Blvd., Chicago	•	•	•	•	•	•
Coronet Radio & Television Corp., Front St., Hempstead, L. I.	•	•	•	•	•	•
Crosley Corp., 1329 Arlington St., Cincinnati, Ohio	•	•	•	•	•	•
Crystal Products Co., 1519 McGee Trafficway, Kansas City, Mo.	•	•	•	•	•	•
Delco Radio, Div. of General Motors Corp., Kokomo, Ind.	•	•	•	•	•	•
DeWald Radio Mfg. Corp., 440 Lafayette St., New York, N. Y.	•	•	•	•	•	•
Allen B. DuMont Laboratories, 515 Madison Ave., New York, N. Y.	•	•	•	•	•	•
Dynavox Corp., 40-35 21st St., Long Island City, N. Y.	•	•	•	•	•	•
Ekstein Radio & Television Co., 1400 Harmon Pl., Minneapolis	•	•	•	•	•	•
Echophone Radio Co., 2611 So. Indiana Ave., Chicago, Ill.	•	•	•	•	•	•
Electrical Research & Mfg. Co., 3001 E. Pico Blvd., Los Angeles	•	•	•	•	•	•
Electromatic Mfg. Co., 88 University Pl., New York, N. Y.	•	•	•	•	•	•
Electronic Corp. of America, 45 W. 18th St., New York, N. Y.	•	•	•	•	•	•
Electronic Devices Co., 601 W. 26th St., New York, N. Y.	•	•	•	•	•	•
Emerson Radio & Phono. Corp., 111 8th Ave., New York, N. Y.	•	•	•	•	•	•
Espoy Mfg. Co., Inc., 33 W. 46th St., New York, N. Y.	•	•	•	•	•	•
Fada Radio & Electric Co., Inc., Long Island City, N. Y.	•	•	•	•	•	•
Farnsworth Television & Radio Corp., Ft. Wayne, Ind.	•	•	•	•	•	•
Federal Telephone & Radio Corp., 591 Broad St., Newark, N. J.	•	•	•	•	•	•
Fisher Radio Co., 41 E. 47th St., New York, N. Y.	•	•	•	•	•	•
Flush Wall Radio Co., 15 Washington St., Newark, N. J.	•	•	•	•	•	•
Franklin Photographic Industries, 223 W. Erie St., Chicago	•	•	•	•	•	•
Freed Radio Corp., 200 Hudson St., New York, N. Y.	•	•	•	•	•	•
Galvin Mfg. Corp., 4545 Augusta Blvd., Chicago, Ill.	•	•	•	•	•	•
Garod Radio Corp., 70 Washington St., Brooklyn, N. Y.	•	•	•	•	•	•
General Electric Co., Bridgeport, Conn.	•	•	•	•	•	•
General Television & Radio Corp., 2701 Lehmann Ct., Chicago	•	•	•	•	•	•
Giffill Bros., 1815 Venice Blvd., Los Angeles, Calif.	•	•	•	•	•	•
Globe Electronics, Inc., 225 W. 17th St., New York, N. Y.	•	•	•	•	•	•
Gray Radio Co., W. Palm Beach, Fla.	•	•	•	•	•	•
Hallcrafters Co., 2611 S. Indiana Ave., Chicago, Ill.	•	•	•	•	•	•
Hamilton Radio Corp., 510 6th Ave., New York, N. Y.	•	•	•	•	•	•
Hammarlund Mfg. Co., 460 W. 34th St., New York, N. Y.	•	•	•	•	•	•
Harris Mfg. Co., 2422 W. 7th St., Los Angeles	•	•	•	•	•	•
Harvey Machine Co., Inc., 6200 Avalon Blvd., Los Angeles	•	•	•	•	•	•
Harvey-Wells Electronics, Inc., Southbridge, Mass.	•	•	•	•	•	•
Herbach & Rademann Co., 522 Market St., Philadelphia, Pa.	•	•	•	•	•	•
Hoffman Radio Corp., 3430 So. Hill St., Los Angeles, Calif.	•	•	•	•	•	•
Howard Radio Co., 1735 Belmont Ave., Chicago, Ill.	•	•	•	•	•	•
Industrial Tool & Die Works, Inc., Minneapolis, Minn.	•	•	•	•	•	•
International Detrola Corp., Beard Ave., Detroit, Mich.	•	•	•	•	•	•
Jefferson-Travis Radio Mfg. Corp., 245 E. 23rd St., New York	•	•	•	•	•	•
Jay Jefferson, Inc., 40 E. Merrick Rd., Freeport, L. I., N. Y.	•	•	•	•	•	•
Kaar Engineering Co., 619 Emerson St., Palo Alto, Calif.	•	•	•	•	•	•
Keith Radio Products, Bedford, Ind.	•	•	•	•	•	•
Kingston Radio Co., Inc., Kokomo, Ind.	•	•	•	•	•	•
Laurehk Radio Mfg. Co., 3931 Monroe Ave., Wayne, Mich.	•	•	•	•	•	•
Lear, Inc., 230 E. Ohio St., Chicago, Ill.	•	•	•	•	•	•
Lincoln Electronics Corp., 653 11th Ave., New York, N. Y.	•	•	•	•	•	•
Fred M. Link, 125 W. 17th St., New York, N. Y.	•	•	•	•	•	•
Magnavox Co., 2131 Bueter Rd., Ft. Wayne 4, Ind.	•	•	•	•	•	•

Manufacturers not listed may furnish data for the next issue. No advertising obligation. Additions or revisions will be made monthly.

	Home AM-FM	Combinations	Television	Auto Radio	Amateur	Commercial*
Maguire Industries, Inc., W. Putnam Ave., Greenwich, Conn.	•	•	•	•	•	•
Majestic Radio & Television Corp., St. Charles, Ill.	•	•	•	•	•	•
Marco Industries, 245-A So. Beverly Dr., Beverly Hills, Calif.	•	•	•	•	•	•
Maritime Radio Co., 24 Whitehall St., New York, N. Y.	•	•	•	•	•	•
Mason Radio Products Co., Kingston, N. Y.	•	•	•	•	•	•
E. W. McGrade Mfg. Co., 406 W. 34th St., Kansas City, Mo.	•	•	•	•	•	•
John Meek Industries, Plymouth, Ind.	•	•	•	•	•	•
Medco Mfg. Co., 5 W. 45th St., New York, N. Y.	•	•	•	•	•	•
Megard Corp., 1601 S. Burlington Ave., Los Angeles, Calif.	•	•	•	•	•	•
Meissner Mfg. Co., 936 N. Michigan Ave., Chicago, Ill.	•	•	•	•	•	•
Midland Mfg. Co., Decorah, Iowa	•	•	•	•	•	•
Midwest Radio Corp., 909 Broadway, Cincinnati, Ohio	•	•	•	•	•	•
James Millen Mfg. Co., 150 Exchange St., Malden, Mass.	•	•	•	•	•	•
Minerva Corp. of America, 238 William St., New York, N. Y.	•	•	•	•	•	•
Music Master Radio Corp., 750 Main St., Hartford, Conn.	•	•	•	•	•	•
National Co., Inc., 61 Sherman St., Malden, Mass.	•	•	•	•	•	•
Noblitt-Sparks Industries, Inc., Columbus, Ind.	•	•	•	•	•	•
Northern Radio Co., 2208 4th Ave., Seattle, Wash.	•	•	•	•	•	•
Packard-Bell Co., 3443 Wilshire Blvd., Los Angeles, Calif.	•	•	•	•	•	•
Packard Mfg. Corp., 2900 Columbia Ave., Indianapolis, Ind.	•	•	•	•	•	•
Pan American Electric Co., Inc., 132 Front St., New York, N. Y.	•	•	•	•	•	•
Phileo Corp., Tioga & C Sts., Philadelphia, Pa.	•	•	•	•	•	•
Philharmonic Radio Corp., 528 E. 72nd St., New York, N. Y.	•	•	•	•	•	•
Pilot Radio Corp., 37-06 36th St., Long Island City, N. Y.	•	•	•	•	•	•
Precision Specialties, 210 N. Western Ave., Los Angeles, Calif.	•	•	•	•	•	•
Premier Crystal Laboratories, Inc., 63 Park Row, New York	•	•	•	•	•	•
Radio Craftmen, Inc., 1341 S. Michigan Ave., Chicago, Ill.	•	•	•	•	•	•
Radio Devel. & Research Corp., 233 W. 54th St., New York, N. Y.	•	•	•	•	•	•
Radio Engineering Laboratories, Inc., 36th St., L. I. City, N. Y.	•	•	•	•	•	•
Radio Mfg. Engineers, Inc., Peoria 6, Ill.	•	•	•	•	•	•
Radio Process Co., 7618 Melrose Ave., Los Angeles, Calif.	•	•	•	•	•	•
Radio & Television, Inc., 244 Madison Ave., New York, N. Y.	•	•	•	•	•	•
RayEnergy Radio & Television Corp., 32 W. 22nd St., New York	•	•	•	•	•	•
RCA Victor Div., Radio Corp. of America, Camden, N. J.	•	•	•	•	•	•
Record-O-Vox, Inc., 721 N. Martel Ave., Hollywood 46, Calif.	•	•	•	•	•	•
Regal Electronics Corp., 20 W. 20th St., New York, N. Y.	•	•	•	•	•	•
Remler Co., Ltd., 2101 Bryant St., San Francisco, Calif.	•	•	•	•	•	•
Rex Products Co., 1315 W. Randolph St., Chicago, Ill.	•	•	•	•	•	•
RH Mfg. Corp., 214 E. 41st St., New York, N. Y.	•	•	•	•	•	•
E. M. Sargent Co., 219 9th St., Oakland, Cal.	•	•	•	•	•	•
Schuttig & Co., 9th & Kearny Sts., N.E., Washington, D. C.	•	•	•	•	•	•
Scophony Corp. of America, 527 5th Ave., New York, N. Y.	•	•	•	•	•	•
Scott Radio Labs, Inc., 4450 Ravenwood Ave., Chicago, Ill.	•	•	•	•	•	•
Sentinel Radio Corp., 2020 Ridge Ave., Evanston, Ill.	•	•	•	•	•	•
Setchell-Carlson, Inc., 2233 University Ave., St. Paul, Minn.	•	•	•	•	•	•
Sheridan Electronics Corp., 2850 S. Michigan Ave., Chicago	•	•	•	•	•	•
Signal Electronics, Inc., 114 E. 16th St., New York, N. Y.	•	•	•	•	•	•
Sonora Radio & Television Corp., 325 N. Hoyne Ave., Chicago	•	•	•	•	•	•
Sonotone Corp., 570 5th Ave., New York	•	•	•	•	•	•
Sparks-Withington Co., Jackson, Mich.	•	•	•	•	•	•
Stewart-Warner Corp., 1826 Diversey Pkwy., Chicago, Ill.	•	•	•	•	•	•
Sromberg-Carlson Co., 100 Carlson Rd., Rochester, N. Y.	•	•	•	•	•	•
Symphonic Radio & Electronic Corp., Main St., Cambridge, Mass.	•	•	•	•	•	•
Syberm Equipment Co., 120 Greenwich St., New York, N. Y.	•	•	•	•	•	•
Tech-Master Products Co., 123 Prince St., New York, N. Y.	•	•	•	•	•	•
Teletone Radio Co., 609 W. 51st St., New York, N. Y.	•	•	•	•	•	•
Telicon Corp., 851 Madison Ave., New York, N. Y.	•	•	•	•	•	•
Templeton Radio Mfg. Corp., New London, Conn.	•	•	•	•	•	•
Trav-Ler Karonola Radio & Tel. Corp., 571 W. Jackson, Chicago	•	•	•	•	•	•
Trebor Radio Co., Box 497, Pasadena, Calif.	•	•	•	•	•	•
United Cinephone Co., Torrington, Conn.	•	•	•	•	•	•
United States Television Mfg. Co., 106 7th Ave., New York, N. Y.	•	•	•	•	•	•
Viewtone Co., 203 E. 18th St., New York, N. Y.	•	•	•	•	•	•
V-lectrical Engineering Co., 828 N. Highland Ave., Los Angeles	•	•	•	•	•	•
Walker, Inc., 403 W. 8th St., Los Angeles, Calif.	•	•	•	•	•	•
Warwick Mfg. Corp., 4640 W. Harrison St., Chicago, Ill.	•	•	•	•	•	•
Waterson Radio Mfg. Co., 2700 Swiss Ave., Dallas, Texas	•	•	•	•	•	•
Wells-Gardner & Co., 2701 N. Kildare Ave., Chicago, Ill.	•	•	•	•	•	•
Western Electric Co., 120 Broadway, New York	•	•	•	•	•	•
Westinghouse Electric Corp., Receiver Div., Sunbury, Pa.	•	•	•	•	•	•
Whiting & Davis, Inc., 23 W. Bacon St., Plainville, Mass.	•	•	•	•	•	•
Wilcox Electric Co., Inc., 1400 Chestnut St., Kansas City, Mo.	•	•	•	•	•	•
Zenith Radio Corp., 6001 Dickens Ave., Chicago, Ill.	•	•	•	•	•	•

\* Commercial or Special.

Republication prohibited. See copyright notice, page 1.

For "Where to Buy Electrical Appliances," see page 76.

## THE NEW FCC ASSIGNMENTS FOR FM AND TELEVISION IN 1946

New	T						NON-GOVT FIXED MOBILE	T			ED. FM		FM		FAC
	44	50	54	60	66	72		76	82	88	92	106	108		
PRESENT	FM		T		Am		T		G		T		G		T
	42	43	50	56	60	66	72	78	84	90	93.3	94.5	96	102	108

Compared with assignments which have been in use during 1945. Changeover had been ordered for January 1, 1946, but recent statements from FCC indicate low FM band (44-50 mc) will be continued in operation in 1946 or until FM service is generally available in the new band (88-108 mc).

Section of **RADIO *& Television* RETAILING**

# **ELECTRICAL APPLIANCES**

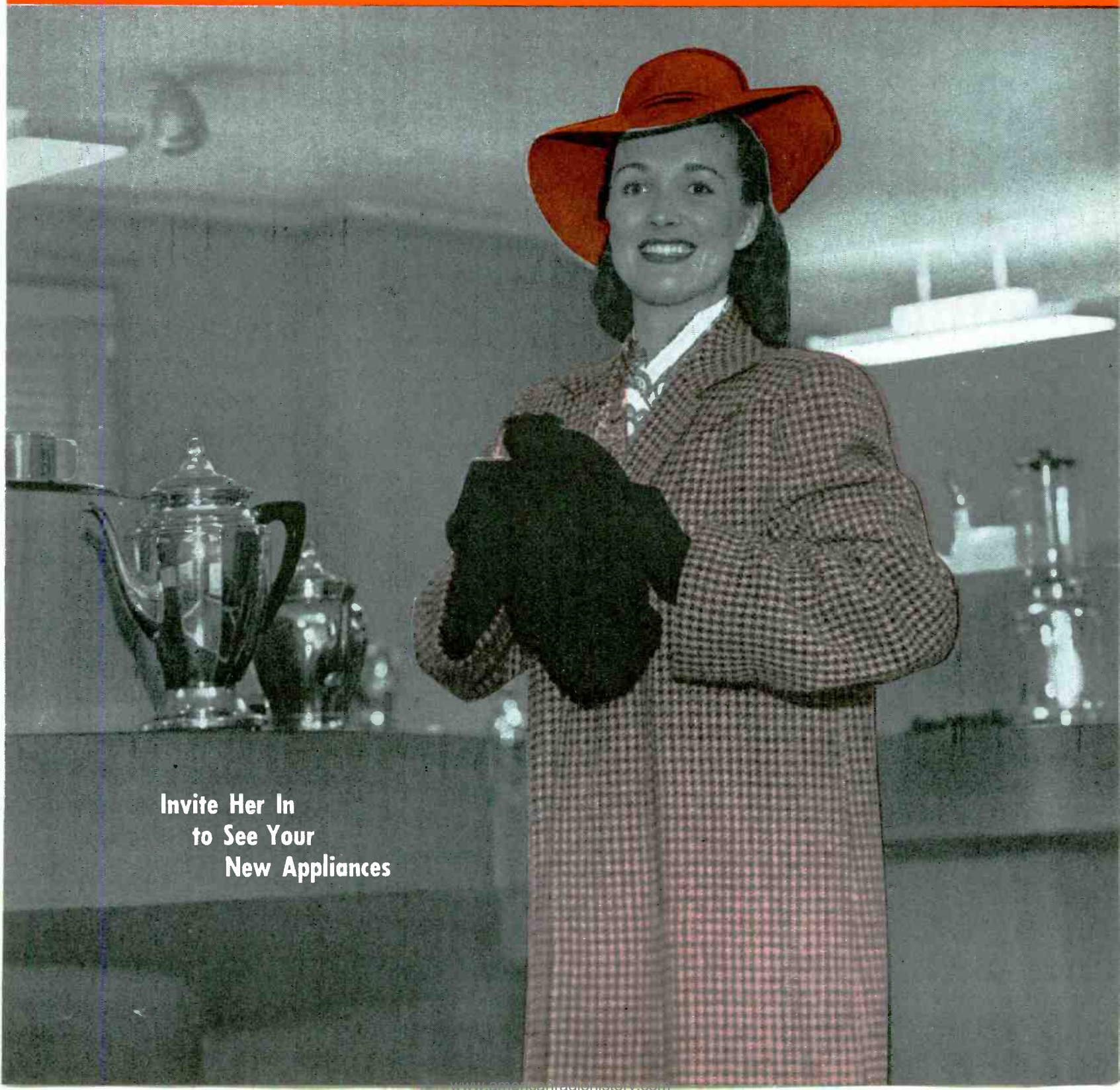

Invite Her In  
to See Your  
New Appliances

**IN PRODUCTION**



**the safer  
no-burn heater  
most people  
prefer**



**NATIONALLY ADVERTISED IN**



**Y**OU'VE never seen a heater like this! Wittie Portable Electric Heater provides *real STEAM heat* . . . quickly and economically. Not just "fire-place" heat . . . but uniform warmth that's air-circulated to every corner of the room. Wittie is safer and cleaner, because it has no exposed glowing coils to cause fire or burn. In light-weight luggage design—handsome as a piece of furniture.

*SPECIFICATIONS: 21½ x 17 x 7¾ inches; automatic safety shut-off; 2-stage heat regulator; operates on AC current; three attractive colors; in "Fan-Blow" or Convection models to suit individual needs.*

Established 1932. Wittie's War Role—designing, engineering, and building ventilating equipment used in tanks, planes, and ambulances.

**WITTIE MFG. & SALES CO.** General Offices and Plant: 1414 S. Wabash Ave., Chicago 5, Ill.

Branch Offices and Representatives in New York, Kansas City, Los Angeles, and Detroit.



# Modernize Your Selling

**Make More Money—Cut Down Percentage of “Lost Sales”  
—Save Time. New Methods for a Great New Market**

● Salesmanship in this great new market calls for highly imaginative, resourceful and modern-minded people.

The day of the “order-taker”, the “order-faker” and the “order-forcer” has gone out with the mustache cup, the buggy whip and the little red schoolhouse.

Modern salesmanship must be bold enough to toss out many moss-covered selling theories — smart enough to retain the sound ones—keen enough to think up sales techniques of its own.

Whether we happen to be the boss, the salesmanager or the salesman, in practicing modern salesmanship, we must strive to accomplish these three things: 1. Make more money. 2. Cut down the percentage of “lost” sales. 3. Save time and shoe leather by using our brains.

We cannot accomplish such a three-fold purpose today unless we are willing to revamp former “notions” of salesmanship before using them in these modern times of television and atomic energy.

The editors of this magazine are firmly convinced that many of yesterday’s selling theories badly need overhauling and more intelligent interpretation—specifically these:

1. “The man who makes the most calls makes the most sales.”
2. “Ask for the order early and often.”
3. “Don’t let the customer interrupt your sales talk.”
4. “Get the order and get out.”
5. “Use a ‘devious’ approach on ‘outside’ calls.”

The editors believe that the salesman who takes all of the foregoing advice literally and follows it to the letter will waste his time, increase his percentage of “lost” sales and antagonize customers.

Let’s take as much interest in

## Salesmanship Is —

- The only profession in the world offering **UNLIMITED** earning possibilities.
- The only **DEPRESSION-PROOF** vocation.
- The only business offering prospects for **UNLIMITED** earnings where a person may, without benefit of academic achievement, **START** at the **TOP**.
- The only profession in the world which consistently pays its followers no more or **LESS** than they actually earn.
- The only career having no age-discrimination angles.
- Salesmanship depends **LESS** upon “pull” in placing its people in jobs than any other business.

modernizing our salesmanship as we take in **modernizing** our stores. Let’s make modern salesmanship more interesting, more ethical and more profitable. As a starter, suppose we take a stab at re-vamping the five old “favorites” to gear them to fit into the present-day selling picture:

1. The man who makes the most sales makes the most money; saves the most shoe-leather. **Don’t** strive to make the **most** calls. Strive to make the **most** sales.

2. **Don’t** ask for the order **prematurely**. It’s easier to deal with a customer’s “yes” than to overcome a customer’s “no.” But—don’t be timid.

3. It’s the customer’s privilege to interrupt your sales talk. Don’t use a routine that’s boring or palpably

“canned.” Be able to “pick up” conversation after any interruption. Be courteous.

4. Don’t grab the order and run, leaving the customer bewildered and offended. Make a calm, gracious exit.

5. Never use a “devious” approach on outside calls. Trickery is disliked by customers. “I’m Mr. Jones of the Doakes Company, and I’m calling to try to interest you in buying a new washing machine” is direct—time-saving.

All of the old “saws” relating to selling have certain merit—certain fundamental truths for our own use, but in these days and times we must exercise more originality, waste less time and “pour on” more personality in our sales efforts. We must modernize our selling techniques.

# Sell Health and Comfort

## Profitable Business in Heat Pads, Sunlamps, Hair Dryers, Vibrators, etc., for Dealer Who Knows How to Merchandise Products

• The merchant in this field who makes a genuine effort to push the sale of health and comfort electrical appliances will add extra profits to his business.

He will also enhance his prestige and build customer good-will since most of such devices are purchased for the prevention of disease, the relief of ills, or for enhancing the appearance of the user.

Therapeutic equipment is personal equipment and with the exception of the electric razor represents the only appliance the dealer sells which is used on the person of the purchaser.

For this reason the dealer selling heat pads, electric blankets, sunlamps, infra-red lamps, vibrators and hair dryers, is doing business upon an extremely intimate basis with the customer who values his opinions and advice on the choice and operation of these "personal" items.

### More Profit for Dealers

In addition to gaining profits and prestige, the independent retailer who goes all out for selling and servicing these appliances, is securing business which belongs to him—not to the "chain" competitor of the type handling inferior and often dangerous junk, and having no service facilities.

Because he handles standard brands and because he knows all about the equipment, the independent retailer should be able to sell any intelligent purchaser when competing with stores handling cheap, inferior makes.

Heat pads, electric blankets, sun and infra-red lamps, vibrators and hair dryers are good all year 'round sellers. While the sunlamp enjoys its greatest sales volume during the winter months, many such devices are sold for the treatment of disease or for use by indoor workers every month in the year.

The electric heating pad has been in use for many years, and to the consumer, is the most familiar of the therapeutic appliances. Prac-

tically every home in the dealer's territory is a source of sales, and quality heat pads can be sold to buyers in all income brackets.

The difference in price between a well-made, approved pad and a "built-down" cheap one is not great, but the difference in safety and durability of the two is so large that it is inconceivable that any independent merchant could find difficulty in selling his standard-brand pad "against" the gyp make.

### Sell Heating Pads

The heating pad produced by the reputable manufacturer represents one of the great values in the appliance product roster. It is extremely doubtful if any other electrical appliance the consumer purchases gives him more for his money.

One has but to look at the conditions under which a heating pad is used to realize that the safety factor needs to be high, and the smart retailer will stress this need to the customer. However, care and judgment must be exercised in selling against inferior makes in order to prevent the timid purchaser from becoming afraid of all such devices.

Electric heating pads are used for the relief of muscular and neuritic pains; to induce sleep in certain types of insomnia, for treatment of circulatory diseases, and the "water-proof" type is frequently used over wet compresses under direction of the physician.

### Cash from Servicing

While it is the opinion of almost all dealers and manufacturers that the retailer's service department should not attempt to handle repairs to the heating element (repairs should be made at the factory) such authorities are united in believing that any well-equipped dealer's service department can handle repairs to any other part of the pad. New line cords may be installed and thermostats can be replaced or repaired. Friction tape

or splicing compound tape should never be used on repairs inside the pad, or near the elements.

In addition to selling service and exterior electrical parts, the dealer can offer new covers to his customers from time to time.

The heating pad is an attractive piece of merchandise for display purposes, lending itself well to colorful packaging. Some makes fea-



In Summer, shut-ins buy sunlamps, heat pads, blankets, etc.

# Appliances Year 'Round

## Easy to Steer Customers Away from Chain Store Purchasing of "Personal" Items by Stressing Need for Safety, Quality Factors

ture removable zipper - fastened covers.

The electric blanket has been on the market for a number of years, and certain merchandising authorities look for it to gain greatly in popularity and sales in the near future. The electric blanket is a luxury-utility item. It is highly recommended in the sick room, where its value has already been

proven, and it provides luxurious rest for the healthy as well. In selling the blanket, the dealer does not have to fear competition with inferior makes, since, at this time there are no "junk" brands on the market.

The dealer who pushes the sale of sunlamps and infra-red producing units stands excellent chance for high monetary profits, and the more he advertises himself as an "expert" on these appliances the more "recommended" sales he'll get from such sources as doctors, nurses, satisfied users, etc.

The sunlamp ties in well with the remarkable current interest in vitamins, since it provides Vitamin D. Some experts claim that the sunlamp's "D" is utilized more rapidly by the system than the ingestion method, and that it is indeed a safe substitute for sunshine—and easier to "control."

### Appeals to Customers

The fact that the sunlamp's ultra violet rays produce tan makes this appliance one of double appeal to the customer who can use it for health and for the improvement of his appearance.

Another "sunlamp" item is the sterilizing lamp, becoming more and more popular as a germ killer.

There are many efficient sunlamp types on the market. Some use a "cold" mercury tube, while others use mercury quartz "hot" lamps, such as the S-4. Still others such as the S1, employ a pool of mercury in the glass envelope which vaporizes when in use.

There are a number of "carbon-arc" type violet ray devices on the market, too. Roughly, these are divided into two groups; the large ones used by physicians and hospitals, and the smaller types designed for use in the home. Goggles must be worn during exposure.

Some sunlamps are also equipped with infra-red, selection being made through a switch. Broadly speaking, "cold" type sunlamps produce little, if any, infra-red rays. The

"hot" types emit varying quantities.

Infra-red lamps do not produce tan or sunburn. They are used as "baking" lamps in treating muscular and neuritic afflictions and under direction of physicians for many other uses. An infra-red bulb, usually 250 watts, is sold by many outlets, but because of the intense heat it generates it cannot be used safely in the ordinary lamp socket. For this reason, the dealer sells the lamp with a fixture. The infra-red lamp with and without flexible necks, come in table models, and in simple reflectors having a clamp for fastening to a piece of furniture.

Electric vibrators are profitable and trouble-free appliances. The merchant must "push" the sale of these items since many customers are unfamiliar with them. Vibrators come in a number of different types, with various sorts of applicators, including those which fit over the hand. They are valuable for use in general massage of the skin and scalp.

Electric hair dryers, providing hot and cold air, are becoming more and more popular, and in addition to the use their name suggests, they are employed for the application of warm and cold air to various parts of the body, for drying freshly-applied nail polish, etc.

### Large Hair Dryer Sales

Just before the war, dealers were doing a big business in hair-dryers, and these devices will certainly increase in public favor from now on.

High grade health and comfort electrical appliances belong in the hands of the independent retailer who becomes sufficiently interested in their many uses so that he can sell them intelligently and profitably.

The independent merchant who points out to the customer the necessity for extreme caution in buying such personal equipment as electrical therapeutical appliances, will be performing a genuine service to the customer, to himself, and to the reputable manufacturer.



Winter, Spring and Fall—sick and healthy buy therapeutic devices

# Electrical Appliance

## Forceful Salesmanship and Traffic Building Key to High Profits; "Double Sales Appeal" Draws Customers

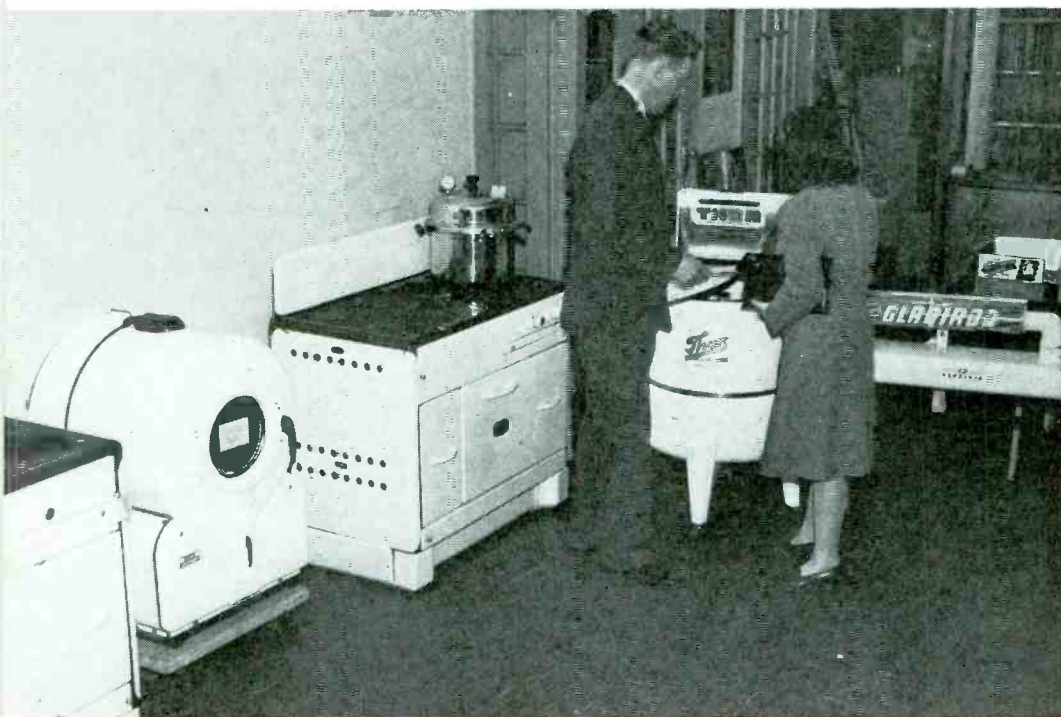

Above, Sven Carlson, general manager, tells customer about superior features of new electrical appliances. Sales not closed on floor are carefully followed up. Dealer Gauthier gives his sales staff weekly talks on up-to-date selling techniques. Below, appliance technician George Meise, formerly in the Army, gets part for washer service job. Large volume maintenance in sets and appliances is done here. Modern filing system helps in keeping close track of all service work.

• "We're out to do a quarter-million dollars volume of business in radios and electrical appliances after merchandise arrives in quantity!" declares Hector Gauthier, proprietor of Gauthier's Good Housekeeping Shop, 230 Main St., Worcester, Mass.

"Our estimate may seem optimistic to some, but we are sure we can reach our goal," this dealer states. Gauthier's aim is not based on wishful thinking. Aggressive merchandising with plenty of push behind its sales efforts is how the firm plans to get its share of the coming profits, "ready for the taking."

"All out selling" for the store means using every possible means with which to make a sale. This includes in-store selling, house-to-house, following up every lead, and going after sales which could not be closed in the store.

"Salesmanship will be more important than ever before," Gauthier asserted. "It's amazing to find many people who did not purchase appliances in the past—even though they wanted to—simply because they were never asked to buy!"

### How to Sell New Goods

To get his sales organization smoothly oiled for profitable selling, this retailer holds sales meetings at his store every Monday morning. Gauthier coaches his six salespeople on such specific points as selling techniques, display, customer policies, etc.

For example, at a recent meeting the establishment's owner discussed with his employees: "New Goods and How to Sell Them." At this meeting, a three-point program on how to make more profits from sets and appliances was outlined. The sales staff was advised to:

1. Become familiar with the new merchandise—know how it oper-



# Selling Methods

ates—read labels and instruction manuals—know the costs of operating various sets and appliances—learn what an appliance will do and what it will not do.

2. Tell customers how to get the most value from what they buy—advise purchasers how to operate appliances correctly, thereby avoiding unnecessary trips to the store for more information.

3. Give customers suggestions on how to buy radios or appliances most suited for their individual needs. Frequently, purchasers do not know the type or size of refrigerator, washer, or ironer which will give them the best performance for the particular work they want done.

## Gives Buyers Advice

For instance, a customer may want a certain lightweight ironer which may not give the buyer the best performance for heavy volume or semi-commercial ironing. Selecting the correct appliance for the job builds much good-will for the retailer as well as putting more cash into his pockets.

Store traffic plays an important part in upping the firm's sales volume. "We do everything possible to get people into our establishment," Gauthier stated. "One of the reasons why some radio-electrical appliance stores do not do as much business as they should is because they do not get enough in-store traffic.

"We believe that you can't sell a shopper until you get him inside the store. Our first step in this direction was to remodel the store completely. Giving the customer an attractive place in which to buy goods is one method we are using to increase traffic."

Many establishments, this dealer believes, are designed to have "women appeal" only. As a result, most of the store traffic consists of women shoppers. "What we have done," Gauthier said, "is to give our store a 'double sales appeal,' thereby increasing store traffic."

The firm feels that in order to sell a radio or electrical appliance—especially on higher priced mer-

*(Continued on page 112)*

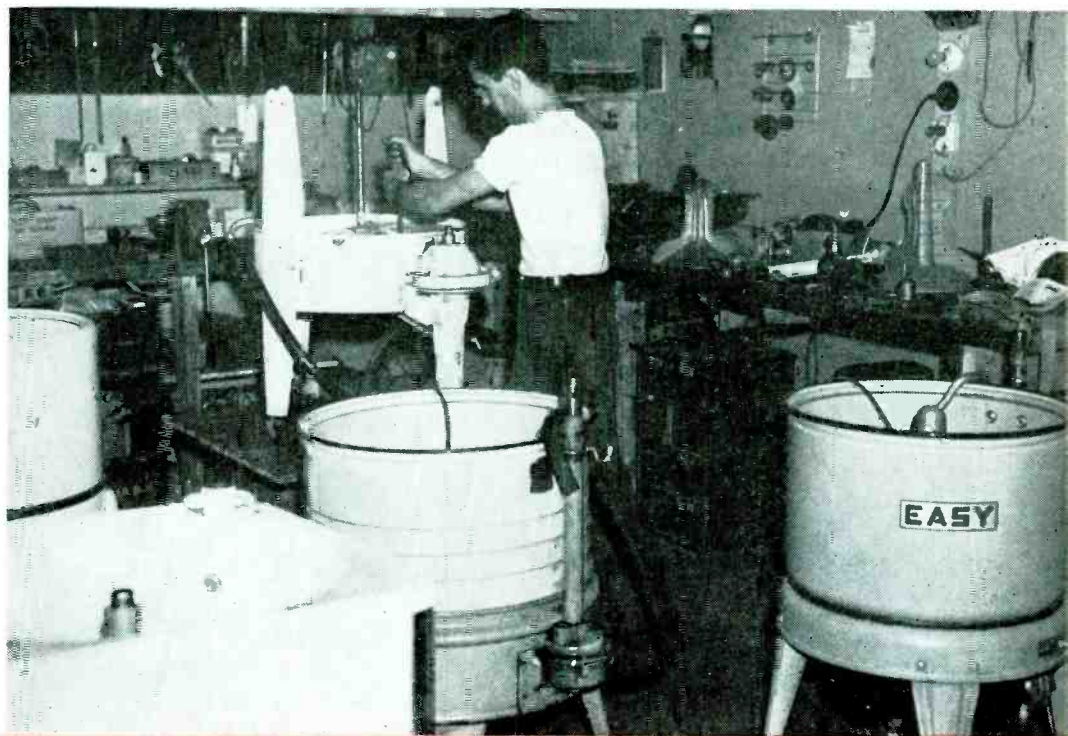

Above, complete overhauls are made on many electrical appliances. Here, appliance specialist Frank Morelli installs gear case in washer. Service shop is large and well equipped. To speed work, intercommunication system connects sales and service departments. Below, General Manager Carlson puts customer at ease while explaining merits of latest washer and ironers. Sales staff is familiar with operation and costs of running new goods. Salesmen are also ready to help buyers select correct appliance for each job. A large record department is maintained here.



**Each Radio Customer Is a Prospect for Electrical Appliances**

America has 36,783,000 families—with 33,100,000 radio homes.

There are:

- 16% more Radio Homes than wired homes
- 27% more Radio Homes than homes with electric irons
- 67% more Radio Homes than homes with electric refrigerators
- 92% more Radio Homes than homes with electric washers
- 100% more Radio Homes than

homes with electric toasters  
138% more Radio Homes than homes with electric cleaners

**And Now the Electric RFD Mailbox**

Farmer O. H. Caldwell of Cat Rock Road, Cos Cob, Conn., has his rural mailbox all wired up with sound effects "so as to notify Ma Caldwell when the postman comes."

The mailbox is located quite a spell from the farmhouse, and the rural mail carrier formerly came and departed without making his presence known. But now let Mr. Hannegan's man slide even so much

as a postcard into the box and chimes are set ringing in the farmhouse.



Joan Caldwell, associate editor "Country Gentleman", rings remote Edwards chimes as she gets mail.

Farmer Caldwell, whose mailbox alarm, "automobile door bell" and electric-eye novelties are additions to his electrical farmhouse in the Greenwich back country, is editor of "Radio & Television Retailing."

—N. Y. Herald-Tribune

**FIND THE "BEST ADVICE" ON THIS PAGE**

"You get a COAL Heater and you won't have any trouble."

"You'll be making a big mistake if you don't get an OIL Heater."

"You wouldn't buy anything but a GAS range, would you?"

"Of course you're going to buy an ELECTRIC range."

**BEST ADVICE:**

Why get into fuelish arguments? ... Get the sale! With the Estate Heatrola "Fuel-Proof" line you have what they want... they want what you have.

Don't lose sales because of fuelish arguments  
LINE UP WITH THE "FUEL-PROOF" LINE"

**ESTATE**  
*Heatrola*  
**RANGES & HEATERS**

RANGES FOR CITY GAS, LP-GAS, ELECTRICITY  
SPACE HEATERS FOR COAL, WOOD, OIL

\*Estate Heatrola is the ONE line of cooking and heating appliances for ALL FUELS... all sold under one famous, nationally-advertised trade name. (Want the name of your Estate Heatrola distributor? Write or wire.) THE ESTATE STOVE CO., HAMILTON, O. • House founded 1842

**APPLIANCE DISTRIBUTORS**

HERE is the line of frozen food cabinets you have been looking for: Smart, distinctive, beautifully designed — soundly engineered . . . including a 3 cu. ft. home storage cabinet—farm freezers—and a visual display self-service retail cabinet for frozen foods and packaged ice cream . . . deliveries begin in January.

WE are now screening distributor applications for our clients . . . a nationally prominent manufacturer who will soon announce this unusual line.

FOR immediate information—and early deliveries—write or wire:

**Bob White**  
ORGANIZATION

Food Industry Consultants  
56 E. WALTON PLACE  
CHICAGO 11, ILLINOIS



## SALES PROBLEMS WON'T PERPLEX YOU IF YOU SELECT SETS *via* GRAYBAR

**RADIO, RADIO-PHONO,  
AND TELEVISION SETS**

**MAJOR APPLIANCES**

**SMALL APPLIANCES**

Selling the sets you get from us is simple. That's because all Graybar-distributed radios and appliances are products of responsible manufacturers — have features of universal buy-appeal — and are backed by effective consumer advertising. Besides, you get the expert aid of Graybar's Merchandising Specialists in training salesmen, arranging displays, and programming promotion.

You're sure of adequate stocks, too. Graybar's nation-wide distribution network makes radios and appliances locally available in just the quantities you desire.

If you want to avoid perplexing sales problems, get in touch with us right away. *Graybar Electric Company . . . in over 80 principal cities. Executive offices: Graybar Building, New York 17, New York.*

4595



### DISTRIBUTION IS MERCHANDISE *and Men*



Meet C. E. Tracewell, one of the merchandising specialists throughout the nation who are guiding Graybar dealers toward new highs in radio and appliance sales.

Following valuable experience with a power company, a refrigeration concern, and a department store, Tracewell joined Graybar in 1934 — selling radios, appliances, and hearing aids in the Cleveland-Toledo-Akron area. Today, as Graybar's District Merchandising Manager at Cleveland, he's one of the leaders in helping dealers apply modern merchandising methods. The Electrical League of Cleveland claims him as a member.

**Merchandising Department**

Refrigerators ★  
 ★ Washers  
 ★ Ironers  
 ★ Ranges  
 ★ Vacuum Cleaners  
 ★ Food Freezers

# Latest in New Ele

### Norge WASHER

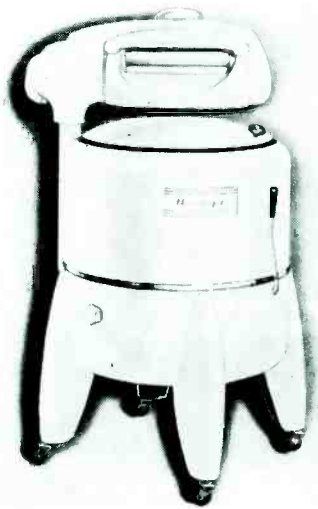

Extra large size tub, porcelain-lined, holds nine pounds of clothes, more than 20 gallons water. Splash-proof top. Plastic "rotator" agitates water. Pressure-cleaner wringer is adjustable to different fabrics. Norge Div., Borg-Warner Corp., Detroit, Mich.—RADIO & Television RETAILING

### Crosley REFRIGERATOR

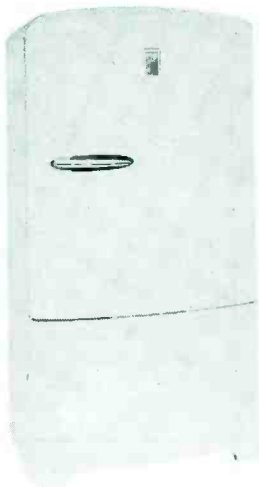

1945 model SS-746 Shelvador refrigerator has a net food storage capacity of 7.3 cubic feet. New improved her-

metically-sealed Electrosaver unit. Large freezer with frozen food storage space. Crosley Corp., Manufacturing Division, Cincinnati 25, Ohio.—RADIO & Television RETAILING

### Frigidaire HOME FREEZER

Four cubic foot home freezer is operated by the Frigidaire 1/9th horsepower Meter-Miser and has the following dimensions: 36" high x 34" long



x 24" wide. Officials of Frigidaire believe that this and other freezers planned for future production will be available shortly after January 1, 1946. Frigidaire Div., General Motors Corp., Dayton 1, Ohio.—RADIO & Television RETAILING

### GE ELECTRIC SINK

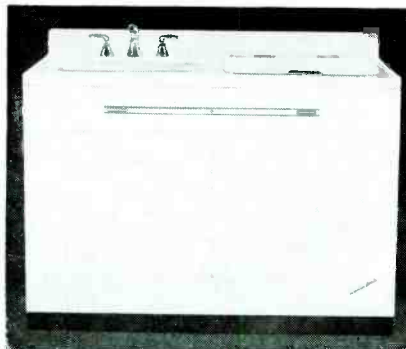

Two General Electric appliances—dishwasher and disposal—are now combined into one unit, the electric sink. Dishwasher portion of unit is operated by two control handles for washing and rinsing. Dishes dry in their own heat. Disposal is attached to drain. Turn of drain stopper starts motor. General Electric Co., Bridgeport, Conn.—RADIO & Television RETAILING

### E-Z Flip TOASTER

First of a new line of automatic toasters, designed for the quality appliance field, features the principle of oven



toasting by retaining the heat within the shell. Touch of the button opens the doors and automatically turns the toast. Merit-Made, Inc., 39 Franklin St., Buffalo, N. Y.—RADIO & Television RETAILING

### Manning-Bowman GRILL

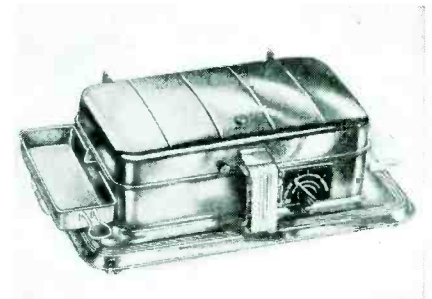

Toasts two full-size sandwiches; grills meat. Interchangeable waffle grids and frying pan attachments avail-



# Electrical Appliances

able for use with this unit. Has signal light in cover to show when automatic device shuts current off. Model shown is the Jubilee. Alternating current. Manning, Bowman & Co., Meriden, Conn.—RADIO & Television RETAILING

## Everhot ROASTER

The Everhot 900 incorporates look-in lid, moisture control, temperature control, cover lifter, deep roaster pocket



and timer clock. New postwar model. Production underway. Deliveries to commence about the first of the year. Swartzbaugh Manufacturing Co., Toledo 6, Ohio—RADIO & Television RETAILING

## Sperti ELECTRIC IRON

New automatic electric iron features heat control located on handle with indications for linen, wool, prints, silk and rayon ironing. Aluminum sole



plate. Fire safety unit. Open handle. Alternating current. Sperti, Inc., Norwood Station, Cincinnati 12, Ohio.—RADIO & Television RETAILING

## Samson HEATING PAD

Has patented Safe-T Selective Heat Circuit with three fixed heats, each controlled by precision thermostats; per-

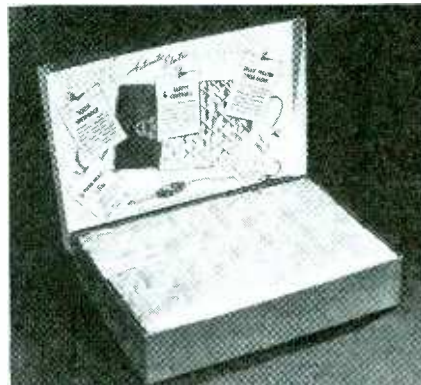

manently sealed wet-proof cover plus an additional water-repellent and stain-resistant cover; "Touch-Tells" indicator for night use, and an 8-foot cord. Samson United Corp., 1700 University Ave., Rochester, N. Y.—RADIO & Television RETAILING

## Philco FREEZER

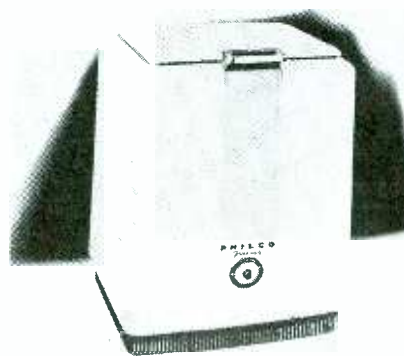

Temperature control permits any desired setting for sub-zero storage, sharp freeze, or use as a second refrigerator in the home. Philco Corp., Tioga & C Sts., Philadelphia, Pa.—RADIO & Television RETAILING

## Kelvinator REFRIGERATOR

One of the new 1946 models, this nine cubic foot Moist-Master is a com-

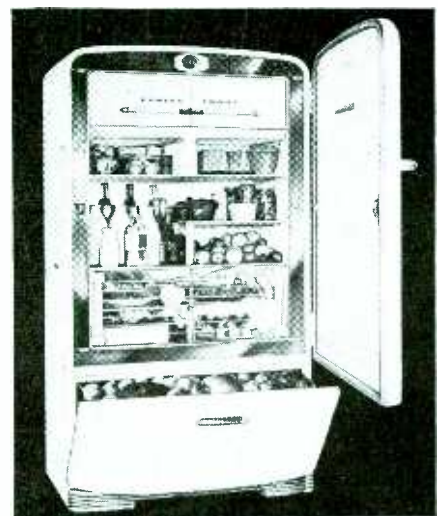

bination refrigerator and frozen food chest. Freezer capacity of 35 pounds of packaged frozen foods and nine pounds of ice cubes. In addition to general storage it has a special compartment for protection of high-moisture foods. Kelvinator Div., Nash-Kelvinator Corp., Detroit 32, Mich.—RADIO & Television RETAILING

## Horton IRONER

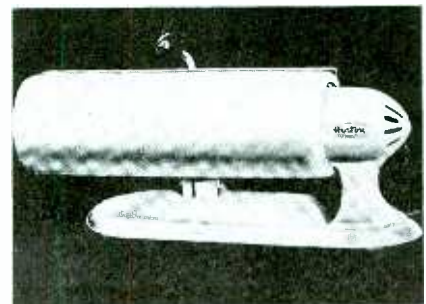

Table model ironer, Model 640A, now in production. Horton Mfg. Co., 731 Osage St., Fort Wayne, Ind.—RADIO & Television RETAILING

(Continued on page 72)

# Many Brand New Models

## Hotpoint DRYER

New automatic tumbler electric dryer readies clothes for ironing in 20 minutes. Control at upper right-hand corner of dryer determines exact degree



of dampness wanted for easy ironing. Edison General Electric Appl. Co., Inc., 5600 W. Taylor St., Chicago 44, Ill.—RADIO & Television RETAILING

## Thermador GRIDDLE

Dimensions 5 $\frac{7}{8}$ " high, 15" deep, 22 $\frac{1}{2}$ " long. Six foot heavy duty cord. Has removable grease tray. Alternate heats from 500 watts to 1500 watts. Its



aluminum alloy grid has a cooking surface of 171 sq. inches. Thermador Electrical Mfg. Co., 5119 S. Riverside Dr., Los Angeles, Calif.—RADIO & Television RETAILING

## Camfield TOASTER

New automatic toaster has a thermostatic device ("equa-therm") which insures even toasting regardless of voltage variations, and a "finger-trip" release which when manually operated



provides inspection of the toast at any time desired. Camfield Mfg. Co., Grand Haven, Mich.—RADIO & Television RETAILING

## Harderfreez FARM & HOME LOCKER

New upright farm and home locker is available in two models: HU-18F frozen food refrigerator 18 cu. ft. frozen food storage, with processing compartment;

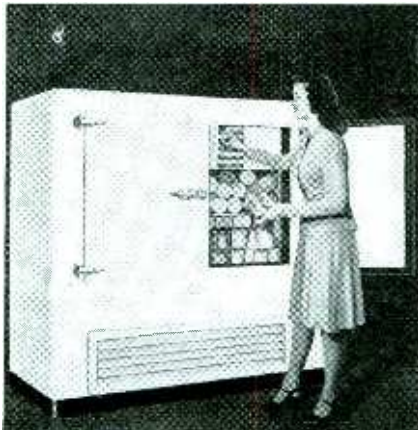

and HU-18D, dual purpose refrigerator, 9 cu. ft. frozen food storage, with processing compartment, and 9 cu. ft. normal temperature storage compartment. Tyler Fixture Corp., Niles, Mich.—RADIO & Television RETAILING

## GE ELECTRIC BLANKET

The company's new improved automatic blanket warms entire bed and maintains degree of heat selected on



thermostatic control. Available in 6 shades. Washable. General Electric Co., Bridgeport, Conn.—RADIO & Television RETAILING

## Dominion ELECTRIC IRON

Lite-O-Matic model, chromium plated, has thermostatic control for rayon, silk, wool, cotton, linen. Weight 4 $\frac{1}{2}$  lbs. Alternating current, 110-115 volts. Handle mounted on air-vents to keep it cool.



Dominion Electrical Mfg., Inc., Mansfield, Ohio—RADIO & Television RETAILING

## Electrestem STERILIZER

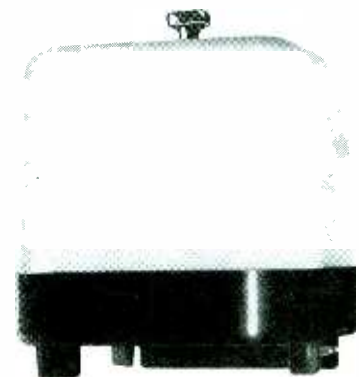

Eight baby bottle sterilizer. Black plastic base with aluminum cover. Heating element is not damaged when unit is immersed in hot water. Now on the market. Electric Steam Products Corp., 5736 12th St., Detroit, Mich.—RADIO & Television RETAILING

## Ilg VENTILATORS

Built-in models in three sizes: Ilgvent for small, Ilgette for medium, and Ilgair



for large kitchens. Available now. Ilg Ventilating Co., 2874 No. Crawford Ave., Chicago, Ill.—RADIO & Television RETAILING

# in Electrical Appliances

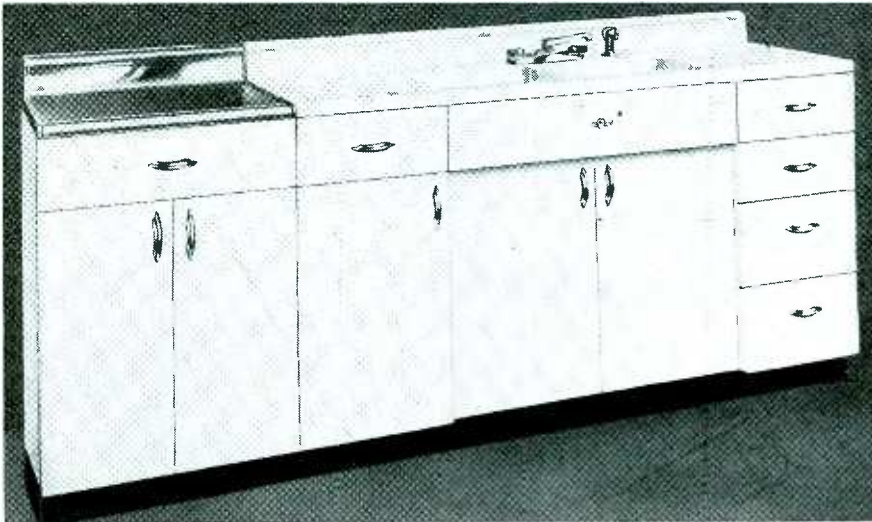

## Youngstown CABINET SINK

First of this firm's kitchen units to come off the production lines, the cabinet sink shown is the largest of the Youngstown standard models. Base cabinet at left features one-piece top. Curving back-splash and front edge are of stainless steel and work area is inlaid linoleum. Mullins Manufacturing Corp., Warren, Ohio—RADIO & Television RETAILING

## American Beauty ELECTRIC IRON

Has adjustable thermostat for temperature changes and thermoscope dial indicating temperatures for rayon, silk, wool, cotton, linen. Model shown is



No. 77-AB. American Electrical Heater Co., 6100 Cass Ave., Detroit 2, Mich.—RADIO & Television RETAILING

## Simplex IRONERS

Simplex Portable Ironette, Model S-463, has two open ends, capacitor

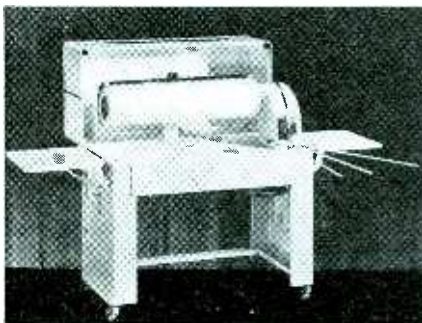

type motor, adjustable thermostat, foot press control, pilot light.

Simplex Royal DeLuxe, Model S-469, complete with end shelves, lapboard, and clothes rods has 2-speed motor, two open ends, dual thermostat controls, both finger-tip and knee control, pilot light.

The company resumed production of portable ironers middle of last October and expects to have started on cabinet

## American KITCHENS

Units available for kitchen design include cabinets, door and drawer fronts, sinks and various combinations of these units can be arranged to give kitchens that "custom-built" look. All-steel construction. American Central Mfg. Corp., Connersville, Ind.—RADIO & Television RETAILING

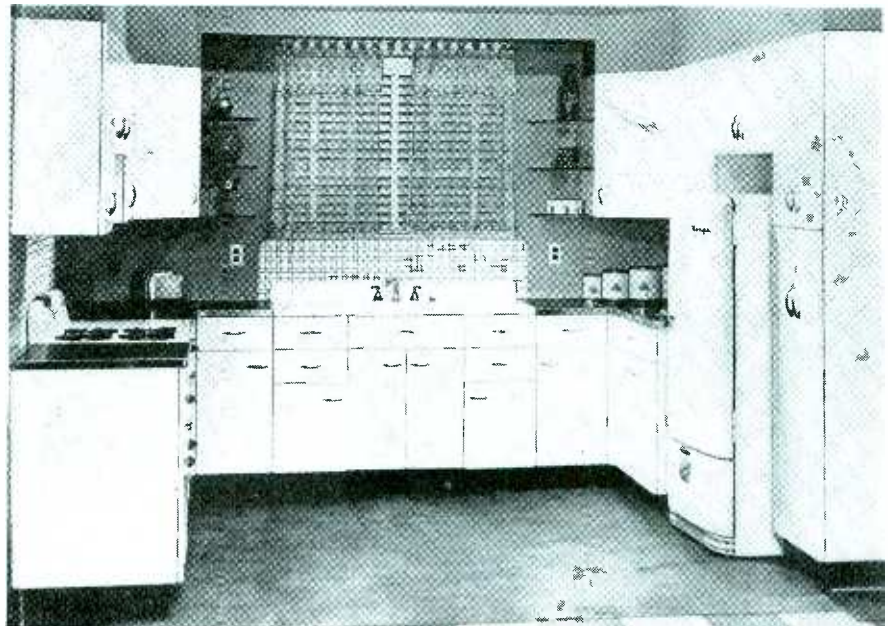

models by December 1st. American Ironing Machine Co., Algonquin, Ill.—RADIO & Television RETAILING

## Mell-O-Chime DOOR CHIMES



Two popularly priced lines of electric door chimes are offered: "Populaire" and "Symphonic." They are designed to give two notes for the front door, one note for the rear door. All models operate on standard home wiring, or any 8 to 10 v transformer. Mell-O-Chime & Signal Corp., Chicago, Ill.—RADIO & Television RETAILING

NEW RADIO MERCHANDISE ON PAGES 44, 45, 46, 47, 48, 49.

# "Sound and Competitive..."

A long-time user of Commercial Credit service, this Detroit dealer is ready for the rising tide of sales.

"Your records will show that my account dates back to 1934. Since then, discounting our contracts and taking advantage of all financial help which Commercial Credit made available has been extremely satisfactory to all our customers and to our own establishment.

"In view of the large volume of financing we anticipate in the near future, it is indeed a great relief and a source of satisfaction to know Commercial Credit is still offering financing services which are fundamentally *Sound and Competitive.*"



*Jack O'Connor* Pres.  
JACK O'CONNOR, Inc.  
Detroit, Mich.  
RADIO and HOME APPLIANCES

## COMMERCIAL CREDIT COMPANY

BALTIMORE 2, MARYLAND

Capital and Surplus more than \$80,000,000



# "It's the Missing Hissing that gets 'em!"



When they find their ears aren't a-clutter with that surface sputter, you've got a sale. Here's the way it works for me:



1. Mr. Jones and his wife want a radio-phonograph. Okay. I simply lead them to the Crosley, put on the big Demonstration Record and step back. They probably say, "You've forgotten to turn it on." You see, they don't hear that familiar needle hiss.



2. Their eyes pop when I tell them it is turned on. I show them the chart pointing up the big difference between the Floating Jewel\* and old-fashioned needles. "Goodbye needle scratch. No more needles to buy, change or listen to—and records last up to ten times longer."

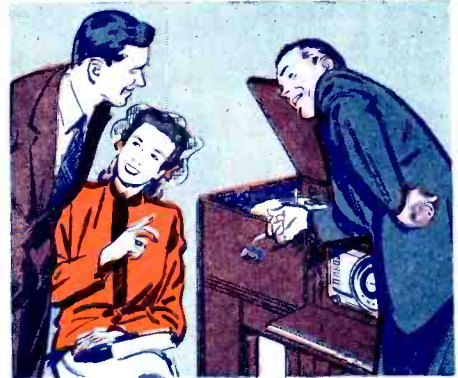

3. Then I play the music. Show them how the Master Tone Control offers 64 different tone combinations—a real Rainbow of Sound. They hear recorded music as they've never heard it before. Sure they're sold. But that's not the end of the story.

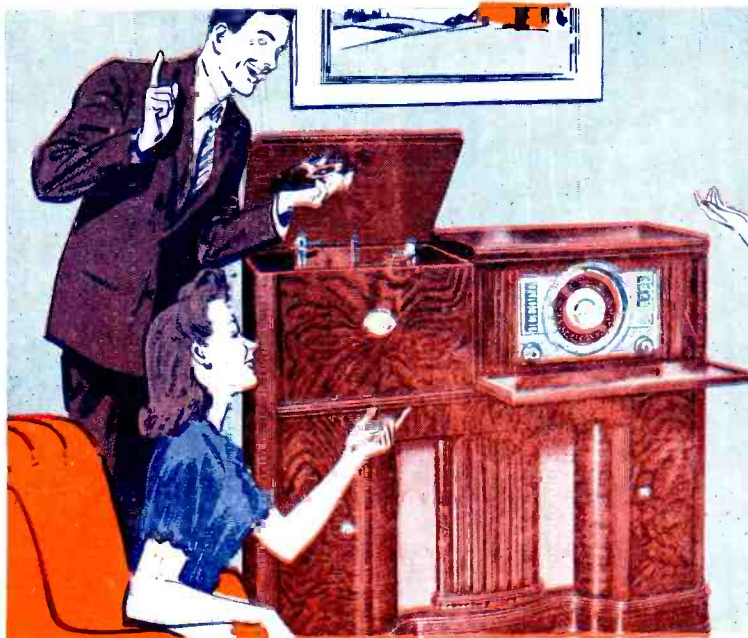

Visit Out Chicago Exhibit—Jan., 7-19  
AMERICAN FURNITURE MART—SPACE 525—FIFTH FLOOR



4. You know the pride people take in a purchase as important as a new radio-phonograph. They show their friends and they sell their friends—more customers for me!

**HEARING IS BELIEVING!** You bet it is. That's what sells any musical instrument—that's what sells the Crosley every time. You'll sell plenty of Crosley Radio-Phonographs and Radios yourself if you follow the simple sales plan outlined above. Expect from Crosley every modern development and improvement in radio-electronic engineering—plus the exclusive Floating Jewel\* and Master Tone Control. Handsome cabinets. Perfect mechanical performance, too! Expect from every Crosley home appliance stand-out features that you can see, or feel, or hear. It's that Crosley *plus* that spells profits for you!



Old-fashioned sharp needles—"Sora-a-tyh! Hi-i-sss! Chatter!!"

Crosley Floating Jewel\* plays the untouched sides of the groove.

\*PATENTED



# CROSLEY

THE CROSLEY CORPORATION, CINCINNATI 25, OHIO

RADIOS • RADIO-PHONOGRAPHS • FM • TELEVISION • SHORT WAVE • ELECTRONICS • RADAR • REFRIGERATORS • HOME FREEZERS  
HOUSEHOLD APPLIANCES • HOME OF WLW, "THE NATION'S STATION"



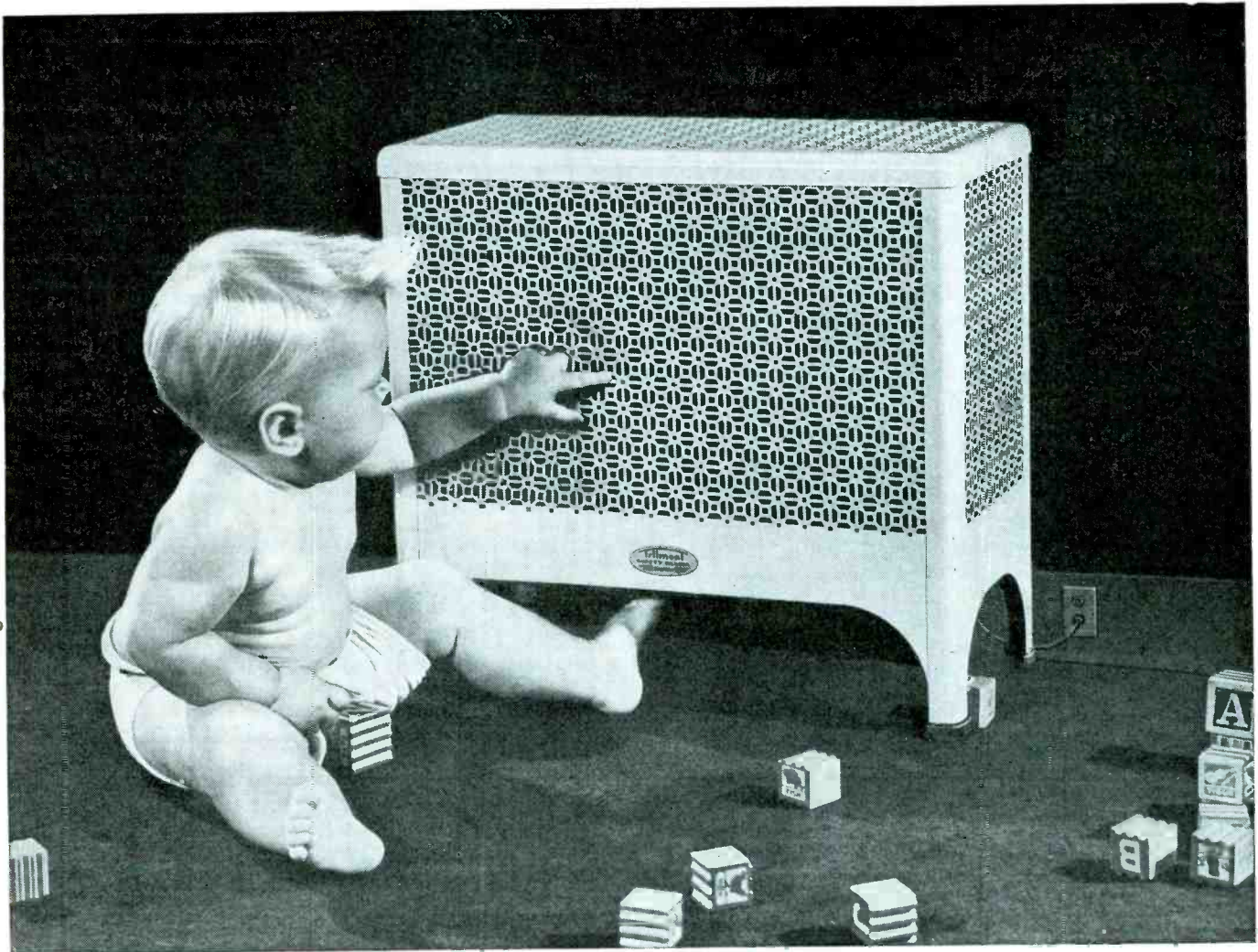

# You're Gettin' Warm, Fella, ... *but not burned!*

**T**HAT'S why mothers favor the TRILMONT Safety Heater above all others. There's no need to tell the children "not to touch," because the sides are always cool... no danger to youngsters, pets or property!

And, unlike other portable electric heaters, TRILMONT raises the temperature of the entire room—not just a spot. Non-glowing coils radiate "black heat" and will last indefinitely without servicing. It needs no fan, no moving parts to circulate healthful warmth wherever auxiliary heat is wanted—bathroom, nursery, sick room, damp basements, etc.

Now is the time to tell your customers that TRILMONT is the ideal gift. Write or wire today for complete data and name of nearest distributor.

#### SPECIFICATIONS...

Width 19½", Height 18¼", Depth 9¼", 120 Volts, 1200 Watts, AC or DC current. Weight 19 lbs. Carries Underwriters' approval.

**\$33<sup>00</sup>** OPA LIST PRICE  
Including Cord Set  
95c EXTRA AT AND WEST OF THE MISSISSIPPI

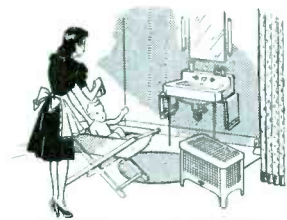

*Provides a cozy warmth for the Baby's Bath.*

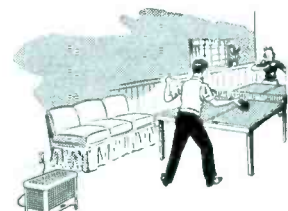

*Takes off the damp chill from Basement Rooms.*

**TRILMONT PRODUCTS COMPANY**  
**PHILADELPHIA 3, PENNA.**

# For Faster Servicing

## How to Use Audio Oscillator and Signal Generator to Simplify Tests of Sets

By R. F. WALLACE and E. D. JACKSON

• In this article, we have outlined our servicing procedure. It may prove helpful to radiomen in systematizing and streamlining their own techniques.

Let us assume that the radio serviceman has a set on his bench, with the complaint clearly and fully noted on the tag, and a notation telling whether the tubes have checked, and what condition they are in. Let us further assume that the set is dead.

Before plugging the radio in, the repairman looks at the cord plug, watching for shorts or opens. This saves fuse replacement if a short is present. Then the set is plugged in and turned on, and tubes and pilot lamps are observed to see whether they light up.

### Removing Parts

While the set is warming up, the chassis bolts are taken out, and the knobs removed, and placed in a tin can on the work bench. If the completion of the job is held up for lack of a part, or because a more urgent repair has to be attended to, these parts are put in a small muslin sack, and tied to the line cord near the chassis. They are always at hand, thus, when the radioman returns to the set, and no time need be wasted hunting for lost screws or knobs.

Defective small parts that are re-

placed during servicing are similarly placed in a sack and attached to the line cord, so that they may be shown to the customer when the set is delivered.

We'll suppose that by now the set has had time to warm up. We listen for hum in the speaker. If no hum appears, the chances are that the output tube or speaker is defective, or else no B voltage is present.

The voltage from plate to cathode of the output tube is noted, and also that between screen and cathode. If voltage is present between screen and cathode, and absent between plate and cathode, there is either an open in the output transformer primary or lead,

or a shorted plate by-pass capacitor. In this case, we immediately switch from volts to ohms, and check for 300 to 500 ohms from screen to plate of the output tube.

In case the primary of the transformer winding shows normal resistance, the ohms reading from plate to ground should be noted, and if a short reading is obtained, the plate by-pass capacitor is unsoldered at one end and checked. This usually clears up the problem, but there is still the chance of a shorted tube, or a grounded lead being present. These possibilities should be investigated if the capacitor tests ok.

In case the voltages were normal on the output tube, the audio oscillator test probe is put into action. There is a .01 mfd capacitor in the lead to prevent shorting out the power supply, so it can safely be jabbed on the plate pin of the output tube.

### Chasing the Signal

If we get the signal through the speaker, we put the probe on the grid of the output tube, from there to the grid of the preceding audio tube, until we get no response, and then we look for the trouble in the area just following the point from which no signal is heard in the speaker. If we don't get signal through the speaker with the probe on the plate of the output tube, the audio oscillator output is put

## How to Speed Repairs

Use audio oscillator to produce substitute signal for testing audio stages.

I.F. modulated signal may be injected to test i.f. stages.

Test suspect tubes by substituting new ones.

Use vtvm for testing oscillator stage voltages.

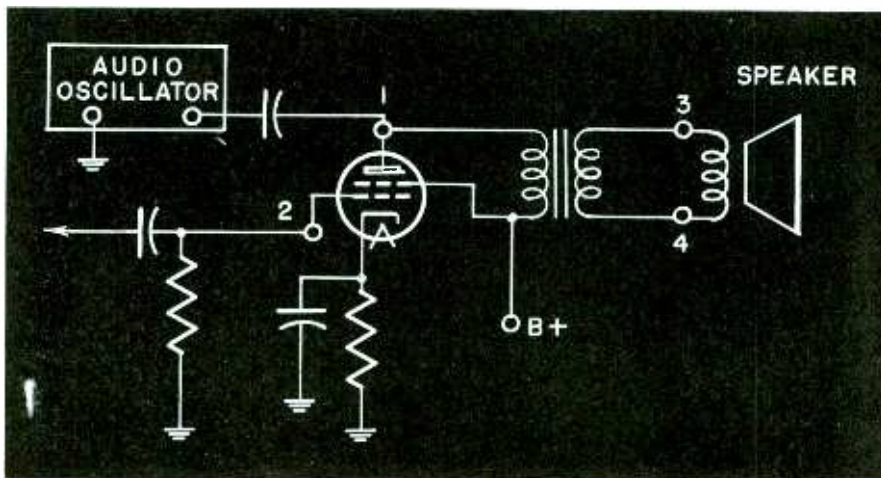

Using audio oscillator to test audio stages. The "high" lead is injected at points 1, 2 and preceding points. To test voice coil, oscillator is attached to points 3 and 4.



across the voice coil leads. If the signal comes through the speaker here, we look for a plate by-pass capacitor that returns to B plus rather than ground, that is shorted, before searching for trouble in the output transformer secondary.

The winding of the secondary is of such heavy wire that it seldom gives trouble, and it generally comes out to the junction panel, so there is no joint to produce defects. The same holds for a hum-bucking coil. If the signal fails to come through when it is applied to the voice coil leads, it is probable that the voice coil is open. To check this, it is necessary to disconnect one of the leads from the voice coil to the output transformer, when it should show one to twenty ohms dc resistance.

If, instead of a no-hum condition, a loud hum is received, most likely there is low capacitance in filter system. When application of a 16 mfd capacitor between screen and ground on an ac set, or 30 mfd on an ac-dc set, fails to take out the hum, it is time to look up the schematic in Rider's Manuals, and get a picture of how the radio is hooked up.

By checking the diagram we may find that the filter system works with the negative side of the capacitors below ground. By identifying some prominent below-ground point in the circuit, we can try our substitutions from that point.

### Hum Test

If the hum seems to come from the filter system (by-passing the output tube grid or grids to ground with a 2 mfd paper capacitor will take out all but filter hum), and if there are several filter capacitors, we check them all for decreased capacitance by bridging them with equivalent units.

Testing for hum source. A 2 mfd capacitor by-passes successively earlier grids to ground.

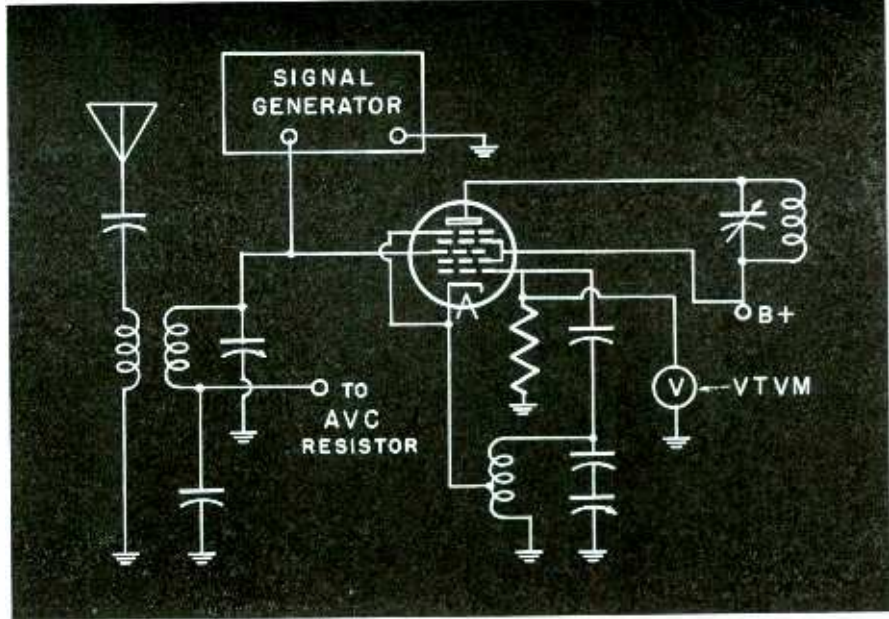
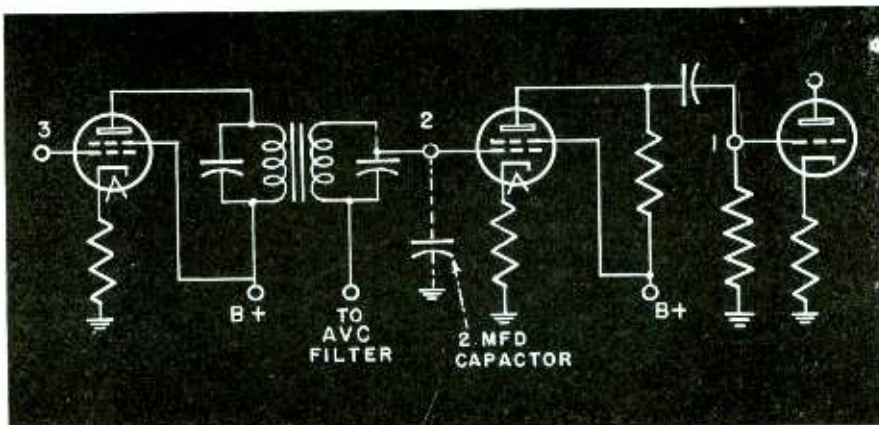

Testing i.f. stages. Signal generator output is applied between mixer grid and ground.

If the hum proves to be of different origin than the filter system, the stage-by-stage method of elimination is tried. The 2 mfd capacitor is used to by-pass successively earlier grids to ground, until the stage that picks up the hum is located.

### Tube Test

At that stage, the associated tube is checked, with a special lookout made for cathode leakage. Resistance is checked in different parts of the circuit, by-pass and coupling capacitors are tested for leakage, and roughly for capacity by bridging with a good capacitor of the right value.

Our tube testing consists of substituting a new tube, or one known to be good in that particular service. For instance, it wouldn't do to substitute a 6J7, that has been removed from an amplifier in which it was serving as a triode, in an

autodyne mixer-oscillator circuit, because it could have a short between the grids which might not show up in triode service, but would render the autodyne circuit inoperative.

Suppose that a set does not pass a broadcast signal at all, but does respond to an audio signal from the oscillator at any point back to the high side of the volume control (in a duo-diode triode detector circuit). Our next test is to see if an audio modulated i.f. signal of the proper frequency will come on through and operate the loudspeaker.

### Testing I.F. Stages

We apply the signal, with the signal generator wide open, to the grid of the mixer-oscillator, and if no signal is forthcoming, the frequency of the signal generator is varied over a wide band to see if reception at any frequency may occur. If none comes through, we return the frequency to that called for in the Manuals, and feed it to the grid of the i.f. tube, changing frequency if necessary to bring in a signal.

Of course, we would notice at once if the stage were completely dead, and would check the tube and the voltages on the pins immediately.

If no reception can be picked up with the test oscillator feeding into the grid of the i.f. tube, signal is fed directly to the diodes of the detector tube. If this fails to bring in a signal, the diodes are tested, resistance of the i.f. transformer

(Continued on page 86)

# Technical New Products

## Kwikheat SOLDERING IRON

Has a self-contained thermostat, maintaining constant heat at all times, and preventing overheating. Elimination of excessively high temperature acquired by conventional soldering iron in "idle" conditions means unusually

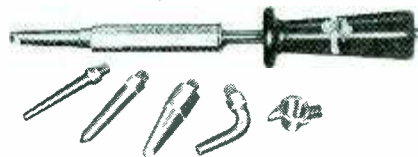

long life expectancy. Tips, too, last longer because they are never overheated, and consequently need less re-tinning. Iron is ready to use 90 seconds after plugging in. This is made possible by a 225 w quick-heating element, which is held in check by the thermostat. Sound Equipment Corp. of California, 3901 San Fernando Road, Glendale 4, Calif.—RADIO & Television RETAILING

## Mallory VOLUME CONTROL

Tapped units provided with plug-in shafts. There are 27 plug-in shafts for use with the TM control illustrated.



Thirteen are replicas of shafts now in wide use—the remaining fourteen need only be cut to length. P. R. Mallory & Co., Inc., Indianapolis 6, Ind.—RADIO & Television RETAILING

## Gits FLASHLIGHT

Plastic, unbreakable, molded flashlight. Features 3-way switch with off-on and signaling positions, shatter-proof plastic lens, and pre-focused light which is thrown in concentrated beam. Available in opaque or transparent plastic case. The transparent case model provides clear vision of batteries for early

checking of corrosive action. Plastic Eye model retails for \$1; Super Right Angle lists at \$1.75, with two bulbs. Gits Molding Corp., 4600 West Huron St., Chicago 44, Ill.—RADIO & Television RETAILING

## Universal BINOCULARS

Magnesium fluoride coating increases light transmission 50%. Waterproof, moisture-proof, dustproof. Individual eyepiece focusing permits accommodation to owner's eyesight. Hinged body, with varying interpupillary adjustment for eye distance. List price, complete with carrying case and shoulder strap,



is \$85. Universal Camera Co., 28 W. 23 Street, New York 10, N. Y.—RADIO & Television RETAILING

## Walsco STAPLE DRIVER

Intended to simplify wiring of inter-communication and p.a. systems, radio antenna and ground lead-ins, etc. Wires can be stapled on in corners, behind pipes, into moldings and other places never before accessible with hammer and ordinary staples. Wires can also



be attached to hard surfaces such as plaster, mortar and even soft concrete. Walter L. Schott Co., Beverly Hills, Calif.—RADIO & Television RETAILING

## Weston INSULATION TESTER

Model 799 is an extremely sensitive direct-reading insulation measuring device for applications where high testing potentials are not desired. It pro-



vides a single range for reading from 0.1 megohms to 10,000 megohms, with the 10,000 mark at 8% of the scale length. Circuit has a test potential of less than 50 volts dc. An electrical guard circuit is provided for elimination of surface leakages when testing cables. Instrument may be used for checking leakage between windings in transformers, cable resistance, leakage of low voltage paper and mica capacitors, etc. Weston Electrical Instrument Corp., 617 Frelinghuysen Ave., Newark 5, N. J.—RADIO & Television RETAILING

## Bruno HOLE CUTTER KIT

For cutting holes of various diameters in wood, metal or plastics. Kit No. 790 is available with straight shanks for use in drill presses, pneumatic and portable electric drills. It contains one



Model 100 Adjustable Hole Cutter (with 1/4 in. shank) for cutting holes 3/8 in. to 1 1/4 in. and one Model 101 (3/8 in. shank) that cuts holes 1 in. to 2 1/2 in. Tools are equipped with high-speed grind for cutting efficiently in wood, metal, transite, masonite and other "problem" materials. Bruno Tools, Beverly Hills, Calif.—RADIO & Television RETAILING

(Continued on page 85)

SEE PP. 70 TO 73 FOR NEW ELECTRICAL APPLIANCES; AND PAGES 44 TO 49 FOR NEW RADIOS

# The Best-Known Name in Tubes



offers you the best  
chance to build  
your service  
business

Now RCA Offers a Complete Line  
of Dry Batteries, Too

Listen to  
"The RCA Victor Show,"  
Sundays, 4:30 P.M.,  
EST, NBC Network

In Metal, Miniature, or Glass—

THE FOUNTAINHEAD OF

MODERN TUBE DEVELOPMENT IS RCA



62-6638-99

**RADIO CORPORATION OF AMERICA**

TUBE DIVISION • HARRISON, N. J.

LEADS THE WAY . . . In Radio . . . Television . . . Tubes . . .  
Phonographs . . . Records . . . Electronics

# Get set for Profits with the

“Golden Throat”



RCA-VICTOR "Golden Throat"

THIS announcement introduces one of the most exciting radio achievements in years...the RCA Victor "Golden Throat," exclusive 3-Way Acoustical System assuring quality of tone that means added prestige and profits for every RCA Victor dealer.

To dramatize the tonal excellence of the new RCA Victor instruments, we have created the "Golden Throat" merchandising symbol reproduced above... an emblem which has all the dignity, splendor and impressiveness of the leadership it represents.

**FEATURED** AS THE HALL-MARK OF QUALITY ON ALL INSTRUMENTS MADE BY RCA VICTOR



To capitalize on the exclusive merchandising power of this symbol of leadership, there will be three "Golden Throat" marks of identification... (1) A handsome replica of the "Golden Throat" design on the volume control knob; (2) An attractive folder explaining the "Golden Throat" in non-technical language and (3) A permanent metallic certificate guaranteeing the instrument as an authentic "Golden Throat" design.

**FEATURED** IN ALL RCA VICTOR SALES PROMOTION AND STORE IDENTIFICATION MATERIAL

Wall charts, catalogue sheets, line folders, brochures and all types of literature will keep up the continuity of the "Golden Throat." Spectacular store backgrounds, illuminated signs, details, streamers, displays for floors, windows and tables will prove focal points of interest wherever potential customers look in your store. All of the material is beautifully designed and built to last.

# New RCA VICTOR

## "Golden Throat"

**Symbol of  
Supremacy in Tone**

One of the biggest advertising and sales promotion programs in the history of RCA Victor is all set to roll to give this merchandising feature quick and thorough identification. Meanwhile we are full-bent on the job of securing materials to build as many RCA Victor Radios and "Victrolas"\*

as possible—at the earliest possible date. As you receive the new instruments you will realize that the "Golden Throat" does more than symbolize thrilling tone—the RCA Victor "Golden Throat" symbolizes a new spirit of leadership with which you will want to be associated in the future.



\*"Victrola"—  
T. M. Reg. U.S. Pat. Off.

# RCA VICTOR

RADIO CORPORATION OF AMERICA

**FEATURED** IN ALL RCA VICTOR MAGAZINE  
AND RADIO ADVERTISING

Throughout RCA Victor advertising the striking "Golden Throat" symbol will occupy a position of prominence. Powerful advertisements in the large-circulation general magazines, outdoor posters and other media will carry the "Golden Throat" story nationwide to millions. In addition, radio commercials every week on "The RCA Victor Show" will pound home the "Golden Throat" Theme, adding still more power and concentration to a campaign already impressively strong.

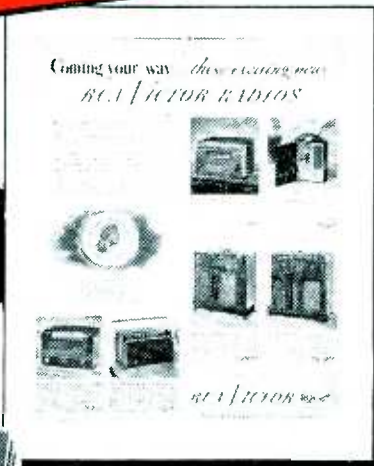

*A complete, compact test-bench  
in a single unit!*



*...the new* **RCA 170-A AUDIO CHANALYST**  
that tests everything—from microphone to multiple speakers

● With the 170-A you can systematically test any sound system completely for failure to operate, weak output, interrupted operation, and distorted or noisy output.

● You can check the presence, absence, or character of a signal throughout its path—from source to load.

● You can check gains or losses, measure component values, and test the voltages of any item supporting or controlling the signal.

● You can narrow down poor performance to its cause, and locate the defective part in an amazingly short time.

● You can use it to solve signal-interruption problems by multi-channel monitoring.

● In an emergency, you can use the RCA Audio Chanalyst to substitute for defective amplifiers by bridging the signal through it, and thus around the defect.

BUY MORE WAR BONDS



**RADIO CORPORATION OF AMERICA**

RCA VICTOR DIVISION • CAMDEN, N. J.

In Canada, RCA VICTOR COMPANY LIMITED, Montreal

# Technical New Products

## Weller SOLDERING GUN

Comes to temperature in 5 seconds. Operates on transformer principle. Trig-



ger switch must be held closed to provide heat. Intermittent heat only when needed keeps the "Speed Iron" in good condition, preventing burning and frequent re-tinning of the tip. Small tip permits easy access to tight corners. Model B shown is 100 w. Weller Mfg. Co., Easton, Pa.—RADIO & Television RETAILING

## Speco SIGNAL TRACER

The Speco Signal Tracer Probe will give audible or visual indication of any signal at any point in a receiver from



the antenna post to voice coil. Unit comprises a detector and sensitive rf and af amplifier, with a low capacity input and a variable gain control. Can be used not only for signal as tracing, but an audio amplifier for testing phono pick-ups, microphones, and audio devices. Special Products Co., Silver Spring, Md.—RADIO & Television RETAILING

## Radio Craftsmen DIAL LOCKS

These dial locks are precision pieces of equipment, formerly used on Signal Corps tuning units, and on other radio units requiring an accurate, fast acting dial lock and tuning indicator. Applic-

able wherever a positive tuning adjustment must be maintained. A wide range of dial thicknesses can be accommodated by these locks. They are made of 21-gauge spring brass, nickel plated. Radio Craftsmen, 1341-3 South Michigan Avenue, Chicago 5, Ill.—RADIO & Television RETAILING

## Hickok CHARGICATOR

Indicates electrically the equivalent gravity of any lead-acid storage battery, regardless of size or voltage.



Places no load on the battery, and at the time of reading, the battery need not be disturbed. The probe type unit illustrated gives instantaneous measurement of battery condition. It shows what charging rate to use, either for trickle charging or for an efficient, safe high-rate charge. It indicates the percentage of charge and charging danger, and warns instantly of destructive overcharging. Weak or defective cells are readily spotted before actual failure occurs. Hickok Electrical Instrument Co., 10523 Dupont Ave., Cleveland 8, Ohio—RADIO & Television RETAILING

## Speco PLASTIC PLIERS

For specialized jobs on radios and electric appliances. Shock-proof, and non-magnetic, these pliers will withstand 6,000 volts breakdown potential. They are heat resistant from 240 to 300 degrees F. Special Products Co., Silver Spring, Md.—RADIO & Television RETAILING

## Superior INSULATION TESTER

Exact leakage of all insulation from zero up to 200 megohms is measured by this Model 610-B Megometer, at a



test potential of 500 v dc. Test voltage is supplied by a built-in battery and vibrator power supply. Resistances from 0 to 200 megohms may also be measured. No hand cranking is necessary—the 500 v potential is made instantly available by simply throwing a front panel toggle switch. Complete with cover, \$62.50. Superior Instruments Co., Dept. U, 227 Fulton Street, New York 7, N. Y.—RADIO & Television RETAILING

## JO TORQUE WRENCHES

Suited to the needs of manufacturers reconverting to the production of washing machines, refrigerators, stoves, radio, and electric appliances. The Jotee,

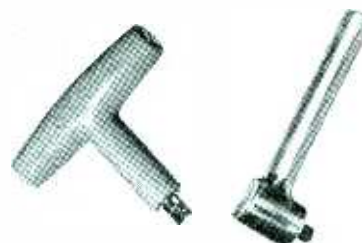

shown at left of picture, is a ratchet type torque wrench, constructed of solid aluminum. Pre-set at factory to any torque within a range of 5 to 40 in./lbs., it may be reset in the plant tool room whenever assembly specifications change. The Joel, shown at the right of picture, has the same range as the Jotee, and is particularly adaptable to close assembly work. It is made in both the ratcheting and non-ratcheting type of tool. Both tools provide positive releasing when the predetermined torque is reached, making errors in judgment impossible. JO Mfg Co., South Gate, Calif.—RADIO & Television RETAILING

SEE PP. 70 TO 73 FOR NEW ELECTRICAL APPLIANCES; AND PAGES 44 TO 49 FOR NEW RADIOS

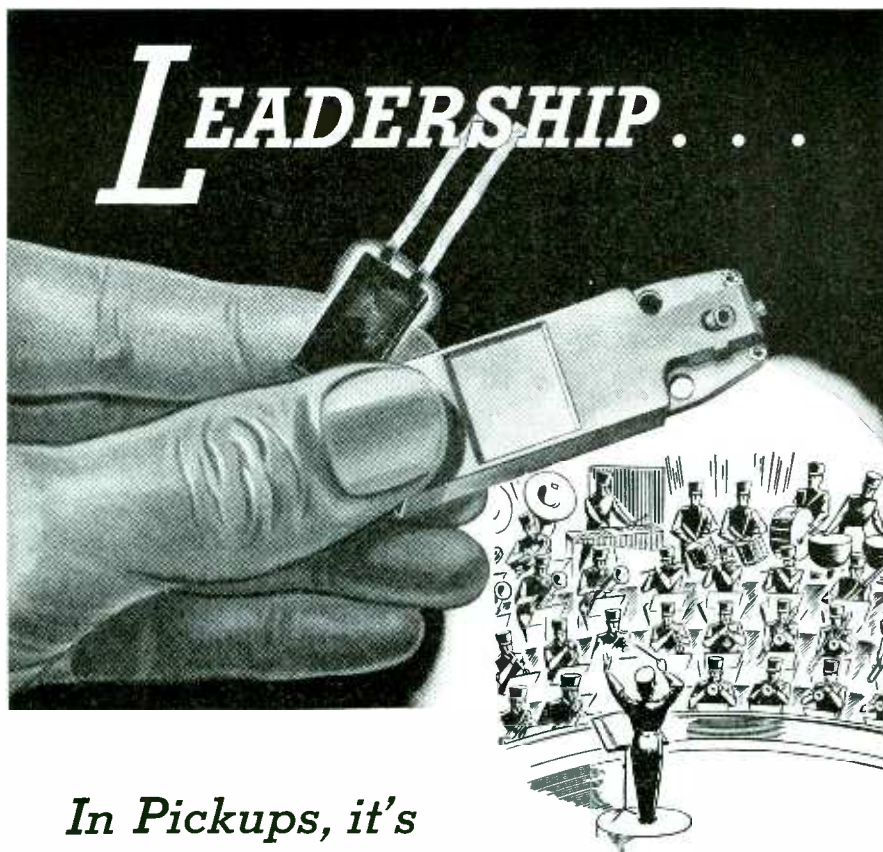

## In Pickups, it's WEBSTER ELECTRIC

• Right now—in these highly competitive postwar days—it is more important than ever before to feature lines of recognized quality and proved leadership. In radio-phonograph combination pickups and cartridges, the Webster Electric line meets these standards perfectly.

The Webster Electric Pickups and Cartridges available today are the finest ever made by an organization long skilled in the manufacture of high-fidelity sound equipment. There are models to fit almost any radio-phonograph combination—and they are priced to give exceptional value to the user and a substantial profit to you.

Take advantage of the current high popularity of fine recorded music in America by offering your trade genuine Webster Electric Pickups. A new pickup often multiplies the listener's enjoyment . . . even though the instrument itself is far from new . . . tenfold! Write for full particulars and a copy of Service Chart RC-147 today. It will help you select the right Webster Electric Pickup for replacement use.

BUY VICTORY BONDS

*(Licensed under patents of the  
Brush Development Company)*

# WEBSTER ELECTRIC

Racine, Wisconsin, U.S.A. • Established 1909 • Export Dept.: 13 E. 40th Street, New York (16), N.Y. Cable Address "ARLAB" New York City

**"Where Quality is a Responsibility and Fair Dealing an Obligation"**

## Servicing Receivers

*(Continued from page 79)*

windings is checked, resistance of the diode load, and so on down the line, until the trouble is located.

Once a signal is brought through the i.f. system, it is aligned. It is often necessary to start aligning at a frequency other than the one prescribed by the book, and slip it up or down, a little at a time, until the signal comes through at the proper frequency.

When we have correct functioning of the i.f. system and following stages, we still may not be able to get a signal of broadcast frequency through the set. This is usually due to failure of the local oscillator. 1A7 tubes are frequent offenders, and we substitute a new tube on general principles when trouble of this sort is present, and a 1A7 is used in the set.

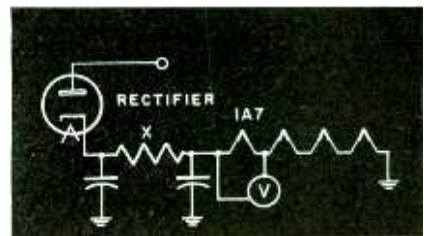

Testing for inoperative 1A7. Filament voltage of less than 1.4 v may cause tube to stop oscillating. Shunting "x" with resistor of about 10,000 ohms or less will often bring voltage and tube operation back to normal.

When the oscillator is working correctly, there is a negative potential from oscillator grid to ground. This can be measured with a voltmeter with a 1,000 ohm-volt resistance, but for accuracy, a vacuum tube voltmeter should be used. Where the set is inoperative over part of the band, and the rotor plates of the variable tuning capacitor are not rubbing, this voltage is noted while the dial is run over from one end of the band to the other.

Absence of voltage at any point often indicates that the oscillator tube is not working well. If this is the case, several new tubes may have to be substituted, before one is encountered that will function perfectly in the circuit under test.

Service technique is, it seems to us, an important part of efficient operations of a radio repair department. We hope our method may prove interesting and helpful to other radiomen.





## READY TO SERVE YOU AGAIN!



*Thordarson* has returned from the war and is ready now to serve its many customers. *Thordarson* regrets there has been an interruption in service performance to regular customers and that orders could not be filled during the war. Here's the reason.

The superior quality of *Thordarson* transformers and other electronic devices was recognized immediately by Uncle Sam at the outbreak of the war and *Thordarson* production (100%) was required to fill all-important government orders.

Now the same high quality that was so acceptable in the recent emergency is available to you. *Thordarson* transformers—always the gauge of superior quality and unexcelled performance—are now even better because of many new additions and developments made during the war. *Thordarson* research-engineering plus *Thordarson* quality team together in the production of better equipment and devices for the electronics industry.

New distribution policies and sales promotion plans make *Thordarson* products and complete informative data on their application and use available to all customers—everywhere!

**ALWAYS THINK OF THORDARSON FOR TOP-NOTCH TRANSFORMERS!**

500 WEST HURON ST., CHICAGO, ILL.



ORIGINATORS OF TRU-FIDELITY AMPLIFIERS



# Servicing Electrolytics

**Detection of High Resistances. Capacitor Repairs. Continued from November Issue, Page 96**

• A "high resistance" often develops in dry electrolytics that results in noisy reception. The noise produced suggests motor interference, and is usually louder on the high than on the low frequency end of the dial. The condition is intermittent, which adds to the difficulty of diagnosing it.

What is probably happening inside the capacitor is a sparking, caused by the temporary operation of the unit at excessive temperature. This condition is particularly apt to occur on midget sets, since ventilation is poor in these radios.

Too much heat weakens the capacitor's dielectric film. As a result, temporary gaps may develop between the metal electrode and the electrolyte, which are jumped by spark currents. When these sparks become large enough, the ac changes they introduce into the power supply modify the signal and become audible as noise.

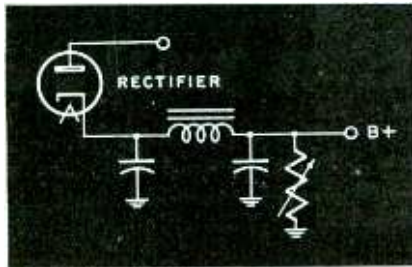

A "high resistance" in an electrolytic filter capacitor is equivalent to a variable resistor in shunt with the capacitor.

Open or short-circuits may eventually develop because of this sparking. The pitting of the foil that takes place, particularly at the terminal tabs, may cause the severance of the electrode or its connector, and thus open-circuit the capacitor. The minute sparks also tend to create dry or carbonized spots on the paper spacer, which makes a flash-over, or permanent short-circuit, more apt to occur.

When a sparking electrolytic is suspected, but the capacitor refuses to "act up", turning the set

## When Replacing Filters

**Use paper capacitors rather than electrolytics on dc sets, to avoid premature blow-outs.**

**Keep electrolytics away from power transformers, high voltage tubes, and high current resistors, to prevent overheating.**

**Check potential in B circuit before replacing filter capacitor, to make sure that the unit's working voltage is not too low.**

off for a while, then turning it on again, may cause the faulty condition to recur. Leakage current in electrolytics is much higher at the start of set operation than at later periods, and the greater power losses that occur within the capacitor as a result, may heat it sufficiently to bring on the sparking. External heat, of course, may also be applied for the same purpose.

## Other Methods

Other methods of forcing the high resistance into the open include squeezing the capacitor with a pair of long nose pliers; tapping it with the handle of a screwdriver, using moderate force; and moving the body or the leads of the unit about.

Repair of defective electrolytics is hardly called for under ordinary circumstances, since replacement is far cheaper and more satisfactory. Cases of emergency, however, do occur, when replacements are not immediately available. Under these conditions, a knowledge of how to make electrolytic repairs may prove of value. These repairs should, of course, be only temporary, and serve merely as a stop-gap until new units become available.

To repair a short-circuited dry electrolytic, the lid should be removed from the container. Tabs

are sometimes dislocated, and come into contact with each other, or the can. If this is found to be the case, they should be correctly repositioned. Insertion of pieces of varnished paper will protect them from subsequent improper contacts.

When the short-circuit is internal, the dry electrolytic should be unwound. When the shorted area is reached, the extent of the damage should be determined. Repair is not recommended if several layers of the spacer have been badly burnt.

If only one or two layers have been punctured, repairs can be effected by placing strips of impregnated spacer, that have been cut off from the outer winding, over the damaged zones.

The capacitor should then be carefully rewound. Breaking of a tab during the repair process can

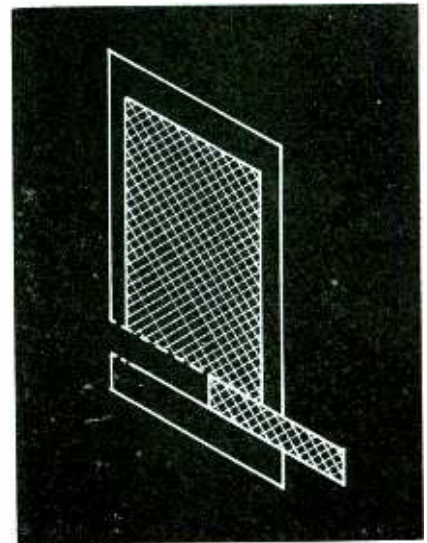

Making a new tab for a capacitor. Outer end of foil is split and bent over.

be remedied by splitting the outer end of the foil to which the tab was attached, and thus making a new tab. The section should then be reinserted into its container, and sealed at its open end with wax or pitch to prevent the entry of impurities.

In the case of open-circuited dry capacitors, loose or corroded tab joints may be to blame. The sug-

gested remedy is to make up a new tab, as previously described. When the outer turn of the foil is found to be corroded, the defective strip should be cut off, the new tab made, and the foils then separated with the spacers. Replacement of the section into the container, and resealing, should complete the repair.

Wet electrolytic capacitors in which mechanical defects occur, may be repaired in the same way as the dry types. Other types of defects in wet and dry electrolytics do not easily lend themselves to repairs.

In making electrolytic replacements, it should not be taken for granted that the container of a dual or multiple section capacitor is necessarily the negative terminal. This is most usually the case, but exceptions sometimes occur.

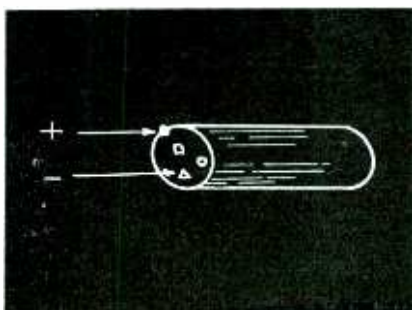

The container of a can-type filter capacitor may, in rare cases, be positive with respect to one of the other terminals.

One Philco set comes to mind on which the capacitor container was at a positive potential in relation to one of the inside terminals. To avoid wasting time, voltage tests should be made before replacing unfamiliar capacitors, to determine what terminal is at the lowest potential in relation to the others.

Filter capacitor replacements on dc sets should not be electrolytics. Paper capacitors should be used instead. Electrolytics may not last long in a dc receiver, since a reversal of polarity occurs every time the set is incorrectly plugged into the outlet.

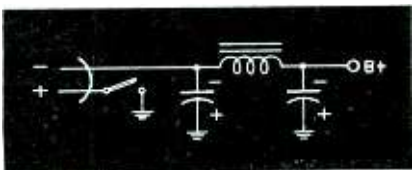

When an electrolytic capacitor is used on a dc set, reversal of the plug may blow the unit.

Radiomen sometimes wonder how much damage has been sustained

by a dry electrolytic that has been accidentally used across an ac supply. The flickering of the lights that occurs suggests that a large current is being passed, and this is actually the case. On prolonged applications, this heavy current will raise the internal resistance of the capacitor, and inflict serious damage because of the greatly increased amount of heat engendered.

On short applications, insufficient heat is generated to damage the capacitor greatly. The cathode foil of the dry electrolytic, however, tends to form an oxide coating, even when the polarity reversal is of short duration. Due to the dielectric properties of the newly formed film, two capacitors in series thus appear. A drop in capacitance results, and this decrease becomes evident when reported reversals in polarity have occurred.

### Capacitors in Parallel

Sometimes a single electrolytic having the desired capacitance is not available. Two or more units may then be connected in parallel, to increase the capacitance. The total capacitance is then equal to the sum of the separate capacitances. Thus, if each of two units has a capacitance of twenty mfd., the total will be 40 mfd. Each of the capacitors connected in parallel must be able to withstand the full voltage that a single unit would have had to endure.

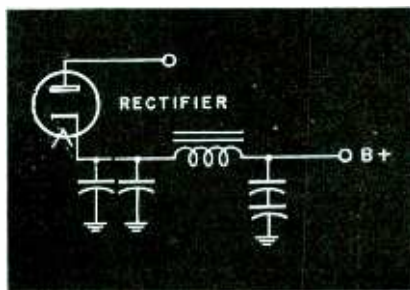

Filter capacitors may be attached in parallel to add more capacitance, or in series, to boost the working voltage.

Electrolytics of high enough voltage rating may sometimes not be readily available for specific replacement jobs. A 10 mfd. electrolytic with a 500 v peak rating, for instance, may not be good enough in a rectifier circuit where the output is 600 v. Two or more capacitors may then be hooked up in series. The capacitance will then be decreased, but the total voltage in the circuit will be divided among the capacitors, so that each of

them can have a lower breakdown rating.

The formula for the total capacitance in a series hook-up is:

$$\frac{1}{C} = \frac{1}{c_1} + \frac{1}{c_2} + \frac{1}{c_3}$$

in which C is the total capacitance, and  $c_1$ ,  $c_2$ , and  $c_3$  are the individual capacitances of the units.

This series hook-up, it should be noted, is not too good for this reason: Failure of one capacitor may result in failure of the others in series with it, since voltage greater than their rating may be imposed across their terminals in such a contingency.

## Service Notes

### Raising 1A7 Filament Voltage with 70L7 Type Feed

When insufficient voltage is present on a 1A7 filament, the transconductance may drop so low that the

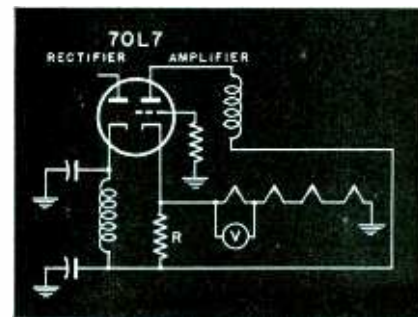

tube will not oscillate. The filament voltage has to be raised in such cases. When a 70L7 combination rectifier and power amplifier type tube is used, the cathode of the amplifier section of the tube feeds the 1.4 volt filaments. A drop in cathode emission causes filament voltages to go down. To avoid replacement of the hard-to-get 70L7, boost the filament voltages by adding a 5,000 to 7,500 ohm 10 watt wirewound resistance between choke output side of the B plus supply, and cathode of the 70L7 power amplifier (see diagram). This results in an increased current through the 1.4 filaments. The exact value of the resistance to be used can be determined most quickly by trial and error. Try 7,500 ohms first, measure filament voltage, then try lower—or higher—resistors, till the correct 1.4 voltage appears.

### 0Z4 vs. 6X5

Some Police Departments have replaced the 0Z4 rectifier with the 6X5 rectifier tube which gives longer life.

More Service Notes on p. 90, 108, 110

## Service Notes

### Wireless Record-Player Test

To test a wireless record player, turn adjacent radio on, and rub phonograph needle of wireless with finger. A loud, scratchy response should result when radio is tuned in to the wireless frequency. This frequency is at the low end of the dial—generally below 570 kc. If wireless doesn't play, it may need tuning. Try adjusting trimmers slightly for 550 or 560 kc. In a noisy spot, like a store, keep wireless as close to radio as possible for loudest reception.

### Intermittent Battery

Fading was the complaint on this battery portable brought in for servicing. 4 22½ volt batteries were hooked up in series to give the required 9 volt supply. When fading occurred, this supply voltage was measured. It had dropped considerably. The voltage drop across each battery was then measured. 3 of the batteries gave normal readings. The remaining one gave a reversed voltage reading—i.e., the polarity of the

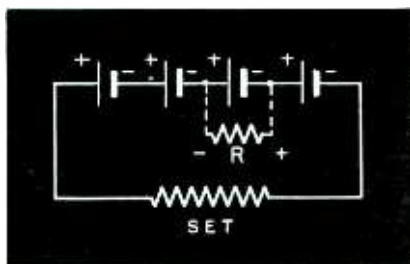

voltage was opposite to what it should have been. When this battery was shorted out, the set's volume increased considerably, and the supply voltage went up. The defective battery was evidently opening internally, and acting, not as a generator, but as a resistance. This naturally caused a drop in the voltage delivered, as well as a reversal in polarity. (See accompanying diagram.)

### Philco Transitone, PT 87

Distortion, and hum that is more evident in between stations than on them, may be caused by improper contact in built-in aerial connections. Two contact-making rods under tension are mounted on the cabinet beneath the chassis. These rods connect the secondary of the built-in antenna. When contact between them becomes imperfect, the symptoms described above will ap-

pear. Bend rods together to improve the contact. These rods are present so that set can be tuned without being removed from its cabinet. By placing one volt-meter test prod to rods, the other to chassis, AVC voltage readings may be taken. Maximum reading will indicate point of correct alignment.

## Book Reviews

### UHF Radio Simplified

By M. S. Kiver. Published by D. Van Nostrand Company, Inc., New York, \$3.25, 238 Pages.

This new book on ultra-high frequency theory is a simplified, non-mathematical treatment of the characteristics of electro-magnetic waves at the ultra-high frequency regions. The first chapter entitled "Introduction to the Higher Frequencies" concerns itself with the transition from ordinary radio circuits to the higher frequencies and the effects produced by the physical size of the various electrical components ordinarily used in common radio circuits. For example, the transit time of the electron tube is described briefly as it affects the performance of ordinary tubes at high frequencies.

The second chapter deals with the magnetron oscillator; the third chapter covers the velocity modulated tube or Klystron type of ultra-high frequency generator. Additional chapters cover transmission lines, wave guides, cavity resonators, UHF antennas, UHF measurements, and wave propagation. A number of questions dealing with the material in each chapter are given at the back of this volume.

### The Effective Reproduction of Speech

Published by Jensen Radio Mfg. Co., 6601 South Laramie Ave., Chicago 38, Ill., 25c.

No. 4 in the series of technical monographs published by Jensen, The Effective Reproduction of Speech covers the important factors necessary for intelligibility particularly at high intensity levels. A number of curves on peak pressures in speech over a frequency band and total power spectrum are given along with data on amplifying ratings, and practical considerations. A bibliography is included at the end.

### Electronics for Radio Men and Electricians

Published by Coyne Electrical School, Chicago, Ill.

A practical book on electronics prepared by the instruction staff of the Coyne Electrical School, this volume is divided into 20 chapters beginning with the foundations of electronics, rectifiers, gas-filled tubes and other applications, vacuum tubes as amplifiers, timing, welding controls, use of high frequencies, photo tubes and circuits, cathode ray oscillograph, and a chapter on maintenance and trouble shooting of electronic equipment.

The book is very well illustrated with a variety of photographs of actual equipment in conjunction with circuits and charts illustrating text material.

The book is intended for the electrician and radioman.

### Principles of Radio

By Keith Kenney, Fifth Edition, 534 Pages. Published by John Wiley & Sons, New York, \$3.50.

This revised fifth edition of an elementary text book on radio is divided into twenty-two chapters starting with the fundamentals of electrons, electrical charges, electric current and related information.

The book continues through direct current circuits covering resistance, voltage drop, power and energy, Kirchhoff's laws. The characteristics of inductance, capacitance, magnetism and the production of electric current are also covered in the early chapters of the book.

Chapter 11 covers the fundamentals of vacuum tubes while the next few chapters treats a tube as an amplifier, as a rectifier, and as a detector. Chapter 16 deals with the characteristics of receiver systems and Chapter 18 covers transmitters. A chapter on antennas and electromagnetic radiation is included as is a chapter on frequency modulation and another on ultra-high-frequency phenomena. The chapter on ultra-high-frequency phenomena includes details of transmission lines, antennas, the magnetron, the klystron, wave guides and cavity resonators.

The last chapter covers some of the fundamentals of electronic measuring instruments such as the vacuum tube voltmeter, cathode-ray oscillograph, etc.

A number of problems are included in the text, as in other editions.

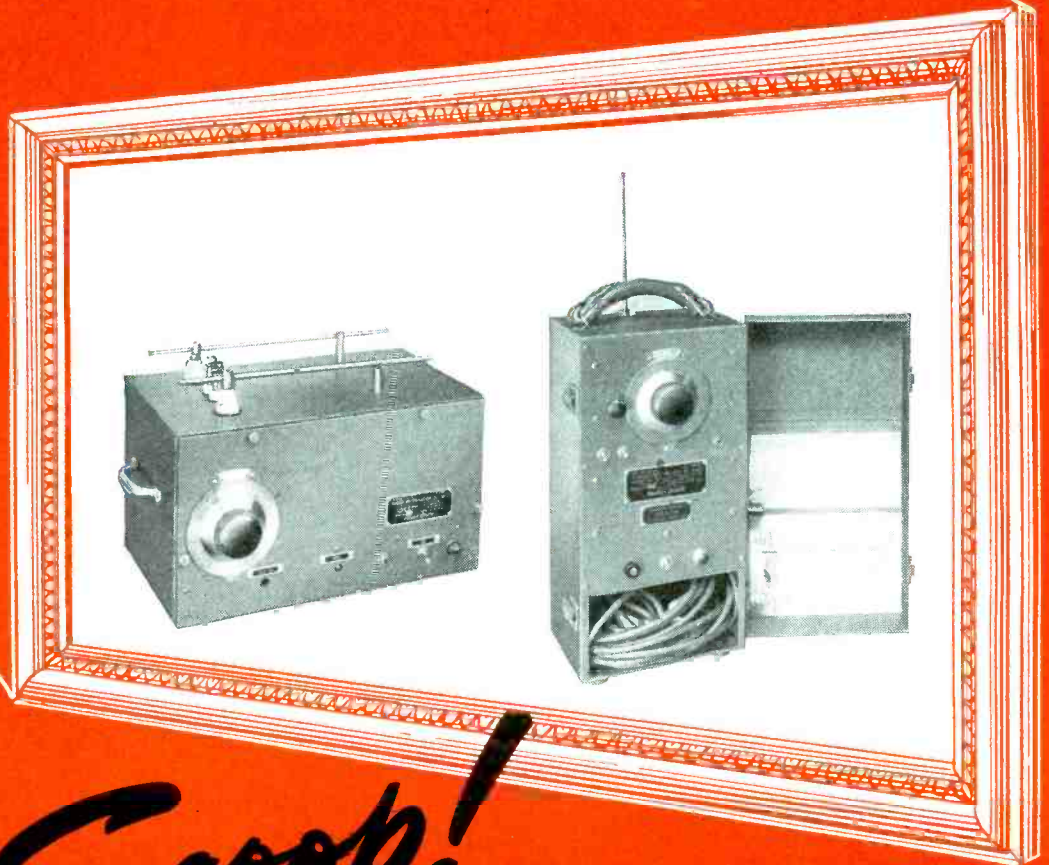

*Scoop!*

**Left: Radio Modulator BC-423.** High frequency signal generator operating from 195 to 205 mc., modulated at approximately 5000 cycles. Ruggedly built in steel case. Designed so that it can be re-adapted to many applications. Can be used as high frequency receiver, transceiver or frequency meter. Good for lab demonstrations requiring low power, ultra high frequency generator. Can be converted to 2½ or 1¼ meter receiver.

**Right: Frequency Meter BC-438.** Ultra-high frequency signal generator operating from 195 to 205 mc. with crystal calibration. Aluminum chassis in steel case. Removable nickel plated 19' telescopic antenna. Use as high frequency receiver or transmitter. Can be converted to cover any frequency range. Takes dry batteries for portable use. Precision tuning control make it ideal for "on the nose" ECO transmitter control unit.

## hallicrafters RADIO

THE HALLICRAFTERS CO., AGENT FOR RFC UNDER CONTRACT SIA-3-24  
MANUFACTURERS OF RADIO AND ELECTRONIC EQUIPMENT

THESE VALUABLE ITEMS *Available Now*  
or very soon. Write, wire or phone for further information • head phones • test equipment • component parts • marine transmitters and receivers • code practice equipment • sound detecting equipment • vehicular operation police and command sets • radio beacons and airborne landing equipment.

### CLIP THIS COUPON NOW

RFC DEPARTMENT 403, HALLICRAFTERS  
5025 West 65th Street • Chicago 38, Illinois  
 Send further details on merchandise d  
above  
 Send listings of other available items  
Especially interested in \_\_\_\_\_  
STATE \_\_\_\_\_  
NAME \_\_\_\_\_  
CITY \_\_\_\_\_ ZONE \_\_\_\_\_  
ADDRESS \_\_\_\_\_

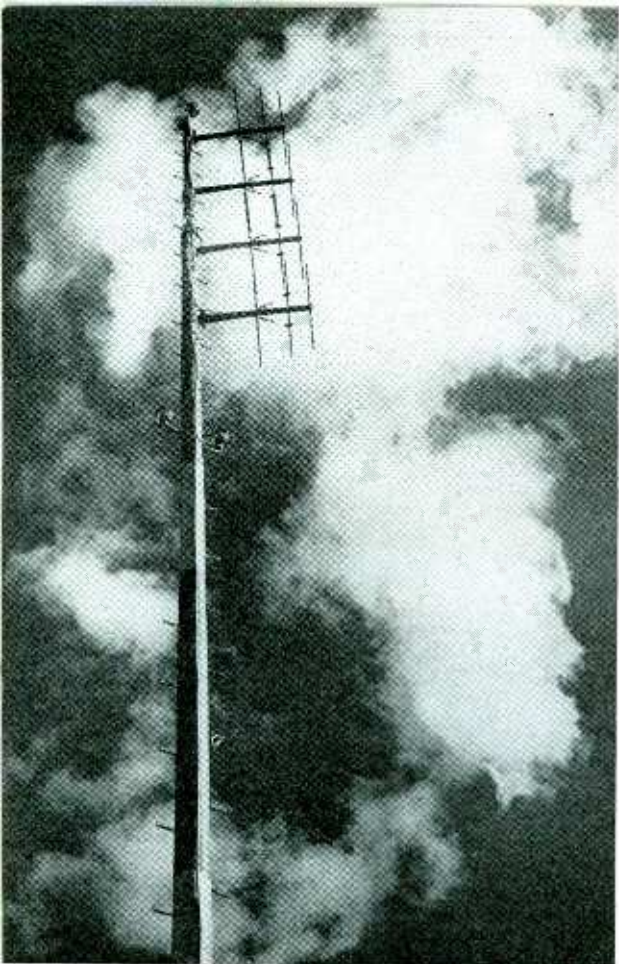

# SAVE FM FOR LISTENERS

listeners who want adequate reception will be required to install costly receivers and lofty elaborate dipoles with reflectors, directors, etc.

In fact, under the new regulations, FM becomes merely a city service, and the rural areas which need FM most of all to eliminate static, are deprived of FM service.

### Big Stations Slashed

It will also amaze radio readers to learn that pioneer FM stations like Alpine and Paxton have actually been cut to only 2 or 3 per cent of their former licensed powers, although these stations will be lone occupants of their new chan-

immediate commercial progress and sales opportunities by banishing it to the high frequencies where transmitter tubes are still limited, engineering problems are not all solved, and home reception meets manifold difficulties.

### To Keep FM Going

In order that FM may go ahead during coming months, we urge that the present FM band (44 to 50 mc) be continued in use for the time being—certainly for a year or so while television does not need this "low-power community channel", and at least until 100-mc FM has demonstrated itself and its inherent engineering problems have been solved.

It is possible, as manufacturers tell us, that AM-FM receiving sets with both low and high FM bands can be sold at only \$4 increase over the cost of the higher FM band alone, then such slight premium would be a good investment for the customers' enjoyment of the fine service on the 44-50 mc band—even if only for a limited time.

### FM Needs More Power on New High Bands;

### Let FM Use Present Band Until Television Needs It

• FM has long been looked forward to as the first item on the radio industry's reconversion calendar.

With 750 FM stations now in sight and nearly every radio-set manufacturer promising to produce FM receivers, frequency modulation was expected to be the big drawing-card of postwar radio sales.

But FM listeners and the radio trade may expect a shock and disappointment when they try to tune in on the new FM high-frequency (88-106 mc) band to which FCC has ordered the new super-broadcasting.

### Elaborate Antennas

Compared with present high field strength and good service on the low (42-50 mc) FM band, listeners on the FCC's new high FM-band will encounter low-intensity signals, reduced station power, bad shadows from foliage and buildings, and night-time interference.

And, at distances from stations,

---

## That the Public May Enjoy and Judge FM

New service needs more power on 88-106 mc

Established stations alone on channels should be allowed all possible power

Meanwhile let FM stations continue on present FM band until television needs it

Give public and trade a dependable FM service during transition

Let public contrast low and high-band services and judge which works best

---

nels. Thus the great Armstrong transmitter on the Hudson, after being licensed at 50 kw output or 250 kw effective power, is now to be cut to 6 kw effective power, which means only 1.2 kw output! Other cuts have been correspondingly disastrous.

A body blow has been dealt FM's

### Give FM Same Chance as TV

Some day, we believe, both FM and television will have their greatest development in the higher frequencies. But just as we insisted that television be given a chance to get a commercial tryout on its present partially-developed low-frequency channels, along with an opportunity to pioneer the uhf region, so—

We urge that existing FM stations and existing FM receivers (representing a combined investment of 50 million dollars on the part of the public) be given a chance to demonstrate FM's matchless service on its present tested and effective channels, while pioneering into the new upper frequencies.

Give FM a chance to continue showing its superior qualities in its present listener-tested band.

Keep FM going during 1946—for the listeners in cities and towns and on the farm!

(See page 136 for more news of FM)

# ADMAN IN WONDER LAND



IT'S THE MOST  
SURPRISING  
MAGAZINE  
I KNOW

## HIS BUDDIES CAME BETWEEN US

"You must remember," Mabel reminded me, "that in the Army our men made new ties. When homesickness struck, their buddies had to take the place of the people they loved but couldn't be with. Now they are back, but part of their hearts still belongs to those buddies of Army days. We must be patient"—I couldn't help interrupting her, "But Cas and I have waited three years to lead

our own life again," I said. "You forget," Mabel replied, "that Cas and Joe and Dice Webster have a feeling of all for one and one for all—something no civilian can understand." "Cas is a civiian now," I said defiantly . . .

WILL THIS BE A  
PROBLEM, TOO?



THERE'S A  
GIRL IN OUR  
OFFICE . . .

## Are YOU On Your Way To Becoming An OLD MAID?

by Carol Lucas

Once there was a girl who lived alone and didn't like it a bit. This girl had hardening of the hearteries at the age of 25. She did have a sweetheart once. Bob was attracted to her looks and style, but her spinsterisms didn't wash with him at all. Pretty soon he began to feel like a naughty boy who had wandered into a museum by mistake. And so, one day he said "Brrr!", turned up his coat collar, and walked out on her. If you find yourself getting angular, it's time to defrost.



**True Confessions "makes you think."** Its readers say so—say that's why it helps them. The things that are in it—like these selections from last September's issue—come out of our readers' lives—they use True Confessions to plan their tomorrows. If we were to get "long-haired" about it, we could call True Confessions "a social force." It is the *magazine for a better life* that is followed, believed in, and trusted. It is the magazine whose growth and development are being watched with great interest by alert advertising men (in a recent survey they also agreed that today's True Confessions keeps on "surprising" them).

Few magazines ever published have been more influential than True Confessions consistently is.

**true** confessions

Bought at newsstands by 2,000,000 women  
a month for the living service it gives

## SPECIAL REQUEST

by Elaine V. Emans

I LIKE IT,  
DON'T YOU?

Walk noiselessly beside me,  
Lord  
Lest for an interval I stray  
In thinking or in deed or word  
From faithfulness to him away . . .

He is so far, and life is so  
Confused, and often lonely,  
Straying is easy, even though  
He is this dear to me. So through  
The dawn and noon, the dusk and night,  
Walk here with me and make it seem  
He is beside me, too, in bright  
Completeness, though it be a dream.



FAWCETT PUBLICATIONS, INC., 295 Madison Ave., New York 17, N. Y. World's Largest Publishers of Monthly Magazines

# Start with any **1** Jackson Instrument to Build a Balanced Testing **TEAM!**



**Condenser Tester**  
Model 650A—Measures Capacity, Power Factor and Leakage



**Sensitive Multimeter**  
Model 642—20,000 ohms per volt—complete ranges



**Electronic Multimeter**  
Model 645—A new Jackson instrument of advanced design

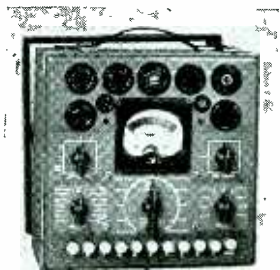

**Tube Tester**  
Model 634—Uses exclusive Jackson "Dynamic" Test Method

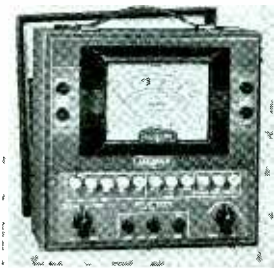

**Multimeter**  
Model 643—1000 ohms per volt. Push key range selection

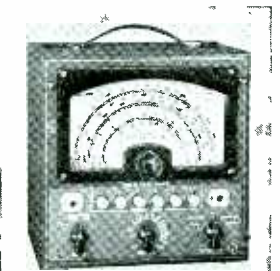

**Test Oscillator**  
Model 640—Accurate to 1/2%, covers full frequency range

IT'S A PLUS VALUE of the Jackson line. Each instrument is engineered and manufactured for long accurate life, as today's users know—but every one is carefully matched in appearance, dimensions and finish as well.

Start with whichever Jackson instrument you need first. Add to it as occasion demands. Your foresight will be repaid with a matched and balanced set of instruments built to give you testing results that you just can't get with hit-or-miss assemblies. Plan now to equip your shop with these Jackson instruments. See your distributor.

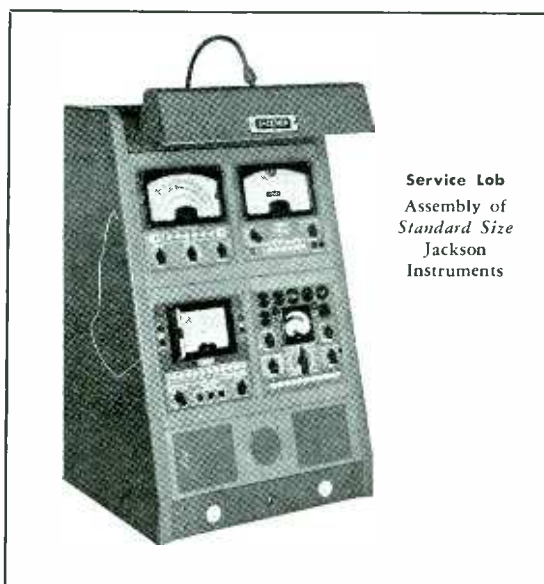

**Service Lab**  
Assembly of  
Standard Size  
Jackson  
Instruments

BUY WAR BONDS AND STAMPS TODAY

# JACKSON

*Fine Electrical Testing Instruments*

JACKSON ELECTRICAL INSTRUMENT COMPANY, DAYTON, OHIO

## Lear Ad Campaign

Homer M. Snow, advertising manager of the Home Radio Division of Lear, Inc., announces the completion of the 1946 magazine and radio advertising schedule for this division of the company.

The schedule will include full pages in color in a list of leading national magazines, and the Orson Welles Almanac, now sponsored over the ABC network, will be continued as part of this campaign.

## Show New Farnsworths

Raybro Electric Supplies, Inc. of Tampa, Jacksonville, Miami and St. Petersburg, authorized distributor for Farnsworth Television and Radio Corp. in Florida and southern Georgia, presented the new Farnsworth radios at their dealers meetings in Jacksonville, Tampa, and Miami. All authorized Farnsworth dealers were invited to attend these meetings in each of their respective districts and the company reports that 95 per cent of their retailers attended.

## New Scott Radio Dial

Scott Radio Laboratories, Inc., is featuring a dial and dial front for their new radios designed by Walter Dorwin Teague. This is in line with the company's announced policy of making precision instruments that reflect beauty in design and workmanship.

## Bozeman in New Post

Appointment of Robert A. Bozeman as district stores manager of Westinghouse Electric Supply Company's southwest district, has been announced by W. A. Emerson, district manager. Mr. Bozeman will make his headquarters in Atlanta.

## Raytheon Launches New Technician "Bonding"

Arthur E. Akeroyd, distributor sales manager of Raytheon Mfg. Co., has announced a new merchandising plan for qualifying radio service-dealers known as the "Raytheon Bonded Electronic Technician Program."

To qualify as a Raytheon Bonded Electronic Technician, a radio service-dealer must meet certain qualifications of experience, reputation and ability . . . and he must have and use adequate equipment to do skilled service work efficiently.

The dealer's application must be approved by his Raytheon distributor and by Raytheon and the bonding agency. When accepted by all parties, he becomes bonded for a period of one year. His bond states that he agrees to guarantee complete satisfaction of every radio repair job for 90 days, and outlines a "code of ethics" that he agrees to observe in the conduct of his business. The requirements for certification have been drawn up so that they parallel the now generally accepted practices and standards of the modern, competent qualified service-dealer, Mr. Akeroyd said.



# RADIART

## 1946 "DELUXE" AERIALS

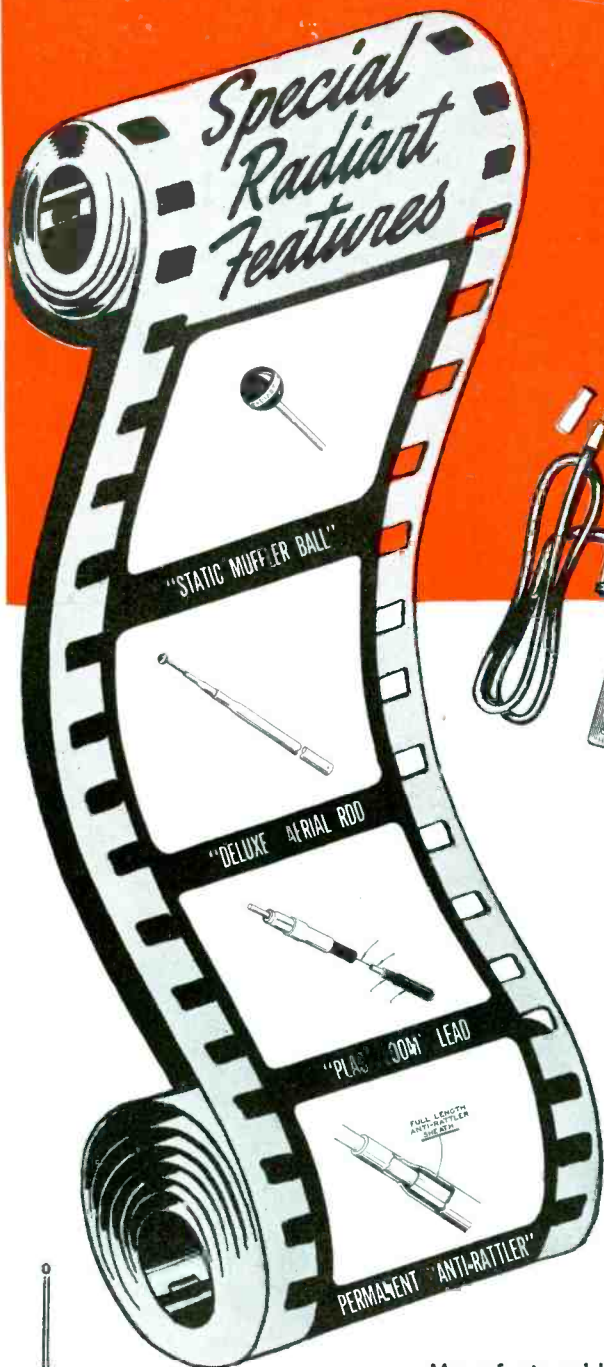

### AGAIN . . . RADIART SETS THE STANDARD!

With new features — highest quality materials — and super values, RADIART AERIALS are the Sensation of 1946.

The "Plasti-Loom" Lead (long enough for all installations) and Antimonial Admiralty Brass are two outstanding Radiart features. They make RADIARTS greater values than ever before.

Also, every RADIART AERIAL is complete — no extras to buy — another reason why RADIART is the line to sell in 1946.



Ask your Radiart Jobber how you can get one of these snappy RADIART AERIAL COUNTER DISPLAYS.

Manufactured by the Makers of RADIART "Correct Replacement" Vibrators.



## Radiart Corporation

3571 W. 62nd STREET  
Export Division  
25 Warren St., New York 7, N.Y.

CLEVELAND 2, OHIO  
Canadian Office  
455 Craig St., W., Montreal, Canada

# New Requirements of FM

## Selection and Use of Test Equipment for Servicing Sets Operating in the New High-Frequency Channels

• Television and frequency modulation receivers use new principles, higher voltages and higher frequencies. These factors make it necessary to have accurate, safe and reliable test equipment, capable of handling a much wider range of tests and measurements. The higher cost of television and FM home receivers must also be considered since their owners will hesitate to turn such sets over to the radio technician unless he can show that his equipment and experience are equal to the job. On the other hand, a service shop that neglects this field of television and FM maintenance, and limits its work to broadcast and all-wave receivers is likely to suffer a loss of prestige in its territory and lose much service work to better equipped competitors. Though standard tube testers, multimeters, etc., will be widely used, a brief listing of the new factors involved in television and FM servicing will show the need for new methods and equipment.

### Higher Frequencies

The rf range of the new test equipment must extend to at least 106 megacycles, the present limit of commercial television and FM allocations. To properly align very-high-frequency (vhf) receivers, the signal generator frequency should be accurately calibrated up to 106 mc, and its output should be adjustable and calibrated. For rapid alignment of the many wide-band amplifiers used in television and FM receivers a frequency-modulating circuit, or "wobulator", will prove very desirable. Point-by-point alignment of a 6-mc-wide i.f. stage, by hand adjustment of the signal generator frequency, is altogether too time-consuming, and the usual "peaking" method of alignment will definitely ruin the performance of any television or receiver. The only practical solution is the method used by manufacturers, known as "visual alignment". The accompanying

block diagram shows the equipment required for visual alignment of a receiver.

The signal generator shown in this set-up should have a frequency range of about 4 to 110 mc and would be used only for alignment and testing of television and FM receivers. The rf output should be adjustable from at least 10 microvolts to 1/10th volt. In the sketch this output adjustment consists of a hollow cylindrical tube which slides in and out of the signal generator to provide variable coupling between the signal generator and the output cable. This type of output control is known as a "mutual inductance attenuator". It is more accurate than the resistance attenuators used at lower frequencies, and its construction and use is quite simple.

### Signal Generator Output

The output cable shown in the sketch connects the signal generator to the antenna terminals of the television or FM receiver being tested. A matched, "twin-coaxial" cable is necessary at vhf to prevent

frequency used. The output cable must have two conductors, each centered within its own shield and terminating in two binding posts for connection to a dummy antenna. Most television and FM receivers operate from a "dipole" antenna, connected to the receiver terminals through a two-conductor cable having a characteristic impedance of about 72 ohms at 40 to 100 mc. If the signal generator output cable has similar characteristics no dummy antenna will usually be necessary, since the function of the dummy antenna resistors is mainly to match the cable to the receiver antenna.

For visual alignment of television and FM receivers the signal generator should incorporate a frequency sweep circuit. This circuit automatically tunes the signal generator frequency up and down over a range corresponding to the band width of the circuit being aligned. The amount of frequency sweep may be adjusted by the control labeled "FM" in the figure, and for television alignment, should extend to at least 3 mc either side of the alignment frequency.

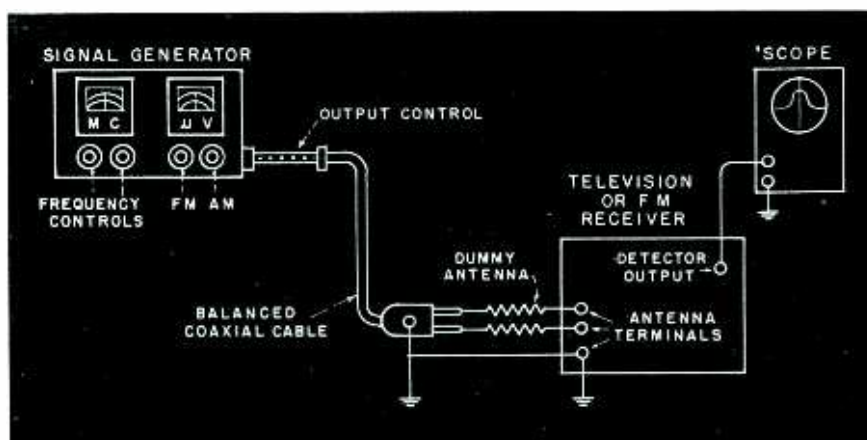

Typical Layout of Test Equipment

reflection of the vhf signals back and forth between the receiver and signal generator. This reflection would cause errors in alignment, since the signal strength would vary, depending on the amount of reflection at each particular fre-

The three graphs in the illustration show the types of patterns that would appear on the screen of the "scope" (cathode-ray oscilloscope) connected as in the circuit just discussed. The top curve shows the flat response (between points

# and Television Servicing

B and D) attainable on good double or triple tuned television—FM intermediate frequency amplifiers. If the older point-by-point alignment were attempted on such an amplifier, it would be necessary to tune the signal generator to frequencies corresponding to A, B, C, D and E, the critical alignment points, while at the same time watching an output indicator and adjusting trimmers on the receiver. Since FM receivers may have ten to twenty trimmer adjustments

television-FM receivers practical for a properly equipped electronic service shop.

For the visual alignment set-up shown in the diagram, any type of cathode-ray oscilloscope would be satisfactory. The vertical input of the 'scope will be connected to the receiver 2nd detector or discriminator, where the signal voltage is relatively high, (about one volt). Any 'scope will be capable of producing a one-inch vertical trace with an input of less than

difficult to see how a complete television service department can function without a suitable cathode-ray oscilloscope. Television experts can diagnose many troubles by observing the picture pattern on the receiver's cathode-ray tube. Unfortunately this tube cannot be connected to various circuits in the set for localizing the trouble, and even the expert must use a 'scope of the best available type for trouble location in the "video" stages of television receivers.

The "best available" types of oscilloscopes, at present, are hardly within the financial reach of many radio service shops. Unfortunately, lower priced 'scopes are strictly limited, in their applications, to alignment work and audio frequency measurements. As a standard by which to judge oscilloscopes in general, the following specifications can be laid down for an instrument capable of handling all "video" signal tracing on television receivers.

### Video-Range Oscilloscope

*Frequency Range*—15 cps to 5 mc,  $\pm 10\%$ , on vertical amplifier. There is some advantage in having identical vertical and horizontal amplifiers.

*Deflection Sensitivity*—0.05 rms volts input should produce at least one inch of vertical deflection. Similar horizontal sensitivity is desirable, but not so necessary. The amplifiers should be capable of spreading the trace to twice the screen diameter without distortion, especially on the horizontal axis. The horizontal amplifier should not cause obvious horizontal distortion, or non-linearity, when viewing the same signal on different portions of the horizontal sweep. This type of defect is common in the lower priced oscilloscopes, and can be detected by applying a sine-wave signal to the vertical input and measuring the horizontal wave length of the trace at various parts of the screen, using a sweep rate of one-quarter to one-eighth the signal frequency.

*Range of Input Voltages*—0.05 to 500 rms volts for one inch deflection. This requires a range of input attenuation of 10,000 to 1, usually obtained by means of a "step"

(Continued on page 98)

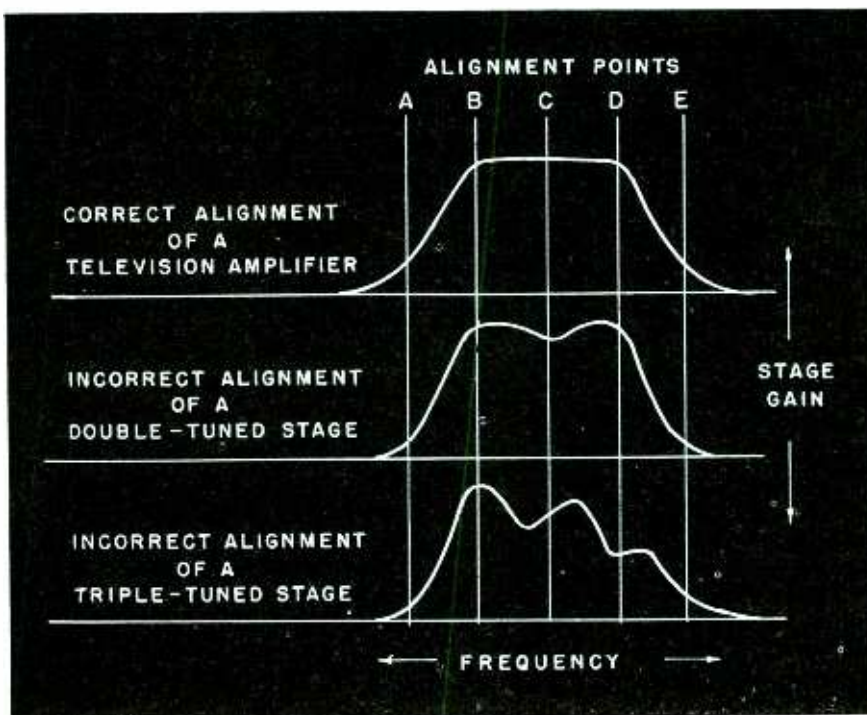

Wide-Band Visual Alignment Patterns

(and television receivers have many more), it is obviously impossible to check five points on each tuned circuit by point-to-point methods. The middle and bottom curves show what might happen if a band-pass stage is improperly aligned. These double and triple humps would distort FM and television signals to such an extent that the receiver would be practically useless, yet their presence would not show up with point-to-point alignment unless at least five frequency points were checked.

By presenting a continuous picture of tuned amplifier response, the visual alignment method overcomes the difficulties of wide-band alignment and makes servicing of

one volt, and the frequency response of the 'scope need not be good, since for visual alignment, the detector signal consists mainly of the 60 to 120-cycle sweep frequency. Before purchasing an inexpensive 'scope, however, it would be well to consider the various applications of the "wide-range" type of 'scope for television and FM servicing, since these more versatile instruments may be better investments in the long run.

During World War II the superiority of the cathode-ray tube, as compared to meters, was definitely proven for most applications involving signal measurements. Since television signals are even more complex than radar signals, it is

**VERSATILE is the name**  
for this **RUGGED TURNER** mike

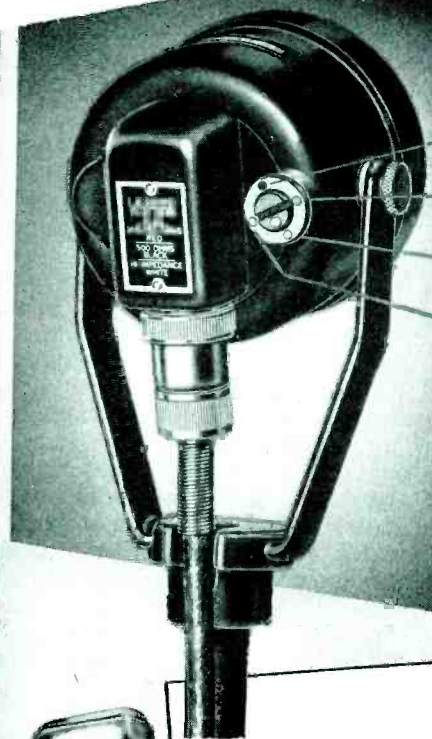

30-50 OHMS

200-250 OHMS

500 OHMS

HIGH IMPEDANCE

**Turner**  
**U9S**

### 4 Impedance Requirements at Your Fingertips

A twist of the "selecto-switch" on the Turner U9S gives you a choice of 30-50, 200-250, 500 ohms or high-impedance to fill practically ANY impedance requirement. Removable cable feature permits quick cable changes and its adjustable saddle fits standard microphone stands and allows semi- or non-directional operation. Professional in both appearance and performance, the U9S is a precision instrument, ruggedly built to stand up and deliver under severe service conditions. It is widely used for commercial broadcast, P.A., and police communications work. Level -52DB at high-impedance with response free from peaks or holes from 40 to 9000 cycles. Gunmetal type finish. Complete with 20 ft. removable cable set. Ask your distributor or write.

Complete Turner Catalog describes fully all  
TURNER Microphones for general and speci-  
fic applications. Write for your free copy.

**THE TURNER COMPANY**  
903 17TH ST. N. E., CEDAR RAPIDS, IOWA



TURNER

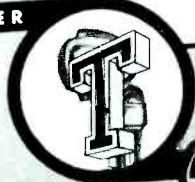

**TURNER**

Pioneers in the communications field

*Microphones*

Crystals Licensed Under Patents  
of the Brush Development Co.

## FM & Tele

(Continued from page 97)

attenuator switch, used in conjunction with a gain control potentiometer.

*Input Impedance*—equivalent to at least one megohm resistance, in parallel with less than 70 micro-microfarads input capacity.

*Signal Probe*, with about four feet of shielded connecting cable, is desirable. The probe should have an isolating network at the input end, the impedance of which should be on the order of one megohm, shunted by not more than 40 micro-microfarads, to reduce loading of the circuit being tested.

*Horizontal Sweep Frequency*—15 to 30,000 sweeps per second from an internal "saw-tooth" oscillator of good linearity.

*Sweep Synchronization*—(1) "Internal", from the applied signal; (2) from an external signal, or (3) from the power line. The latter is required for measuring hum voltages which may be too small to synchronize the sweep in any other way.

*Intensity Control*—either by hand, or from a signal connected to an "Intensity Modulation" terminal.

### Fine Points of Tele

Other television service problems include:

a. Cathode-ray tube testing, preferably by applying test patterns from a video pattern generator.

b. VHF antenna installation and maintenance. A portable field strength meter would be very useful for this work.

c. RF voltage measurements up to frequencies of 110 mc. AC vacuum-tube voltmeters equipped with high-frequency probes are capable of measuring stage-gain, etc., at frequencies far above the range of the best oscilloscopes. Their use, however, should be limited to unmodulated or "continuous wave" signals.

Much of the test equipment mentioned above will not be placed on the market until wide-spread sales of television and FM sets create the necessary demand. Nevertheless, service technicians who wish to remain at the head of their profession are advised to prepare for the new service requirements by keeping in touch with the latest developments in this field.

# Automatic Radio

## They'll be worth waiting for—



**Y**es, they'll be worth waiting for, these new postwar Automatic Radios— they'll be the product of 25 years' experience in the art of making fine radios—plus war developed skills and materials in building sound equipment for the Armed Forces.

New tonal qualities, new beauty of design and new operation improvements that will be priced for quick turnover. You can count on quick radio profits, if you are ready to sell Automatic. Write us today, and we will put you in touch with the Automatic Radio distributor in your territory.

 **Automatic**  
RADIO MANUFACTURING CO., Inc.  
122 Brookline Avenue, Boston, Mass.

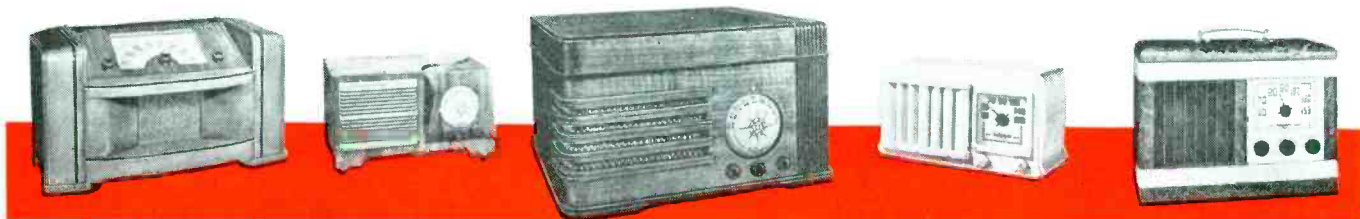



Race tracks offer market for PA systems which brings financial rewards. Corley Sound Service, Trinidad, Colo., installation is shown in photo.

### ***There's Big Money in This Field; Sales and Service of PA Systems Provide Large Profits***

● The hoary specter of competition in merchandising, safely buried during war days, is getting ready to leave its grave and haunt the dealer once more. The witching hour has not struck yet—merchandise is still too scarce. When the industry's reconversion output, however, broadens into a mighty river, and supply becomes more plentiful than demand, competition will become a serious problem.

#### ***Steady-Profit Lines***

The inevitability of such conditions should make dealers think about the addition of profitable lines. The selling, installation, and maintenance of sound systems constitutes one of the biggest and most promising of these activities. Competition will never be as intense in this expanding, ever-hungry field because competence is a more important factor than price.

Left, Frisch Radio, New Brunswick, N. J. This store finds sound a profitable business. Right, auto races are sources of "sound" income.



Ruthless competition is possible in radio merchandising because price is the major factor, and any fool can slash prices, even if he cuts his own throat in the process. The sale of sound systems, however, is a horse of another color—a bronco not as easily ridden, since skilled installation and maintenance are requisites.

#### **Seek New Customers**

Many opportunities await the dealer who is alert to the possibilities of sound installations. Any number of businesses may be found where efficiency could be considerably increased by the installation of paging or intercommunication systems. The dealer who studies

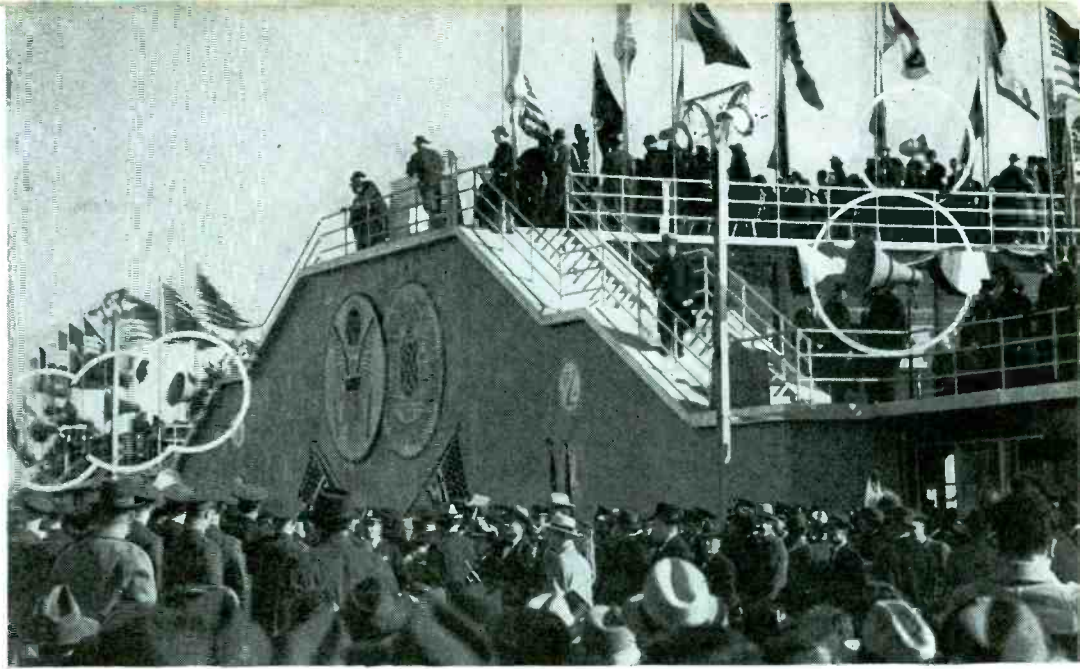

Outdoor rallies, political meetings, etc., mean more business for alert sound dealers.

## **and Maintenance**

the needs of potential customers, and finds out how a sound system may benefit him, will provide himself with effective weapons for beating down sales resistance.

Some industrial plants have been using music, fed from central equipment into loudspeakers scattered through the workrooms, to improve employee morale and thus

speed up production. We see no reason why a sound merchant cannot send out salesmen to plants that do not use this system, to present the executive with facts and figures showing the increased output obtained by the introduction of music into workrooms. These statistics could be gotten from businesses that have used such systems

successfully, and would serve as convincing arguments.

Piped music may be used in hospitals, to speed the recovery of patients. The therapeutic value of music has been recognized for some time. Veterans' hospitals have begun using musical therapy. Other hospitals may also find it useful.

It should not be too difficult to convince a medical director that music piped into the rooms of his hospital would lighten the painful or bored hours of the patients, and make their stay more pleasant. The hospital could make a separate charge for this service, in the same way that it bills patients for private telephone service. The alert sound merchant will not neglect this potential market, which can provide profits both in sales and maintenance.

High schools and private academies frequently need sound systems. Rentals may be made, for use at graduation time, or on other special occasions. PA systems are necessities on sports fields, and in auditoriums and chapels of schools. Where permanent installations are desired, or already present, yearly maintenance contracts may be obtained.

Other potential markets for the sound merchant include country club events, fairs, rodeos, carnivals, horse shows, and horse races. Rentals and installations should bring

*(Continued on page 120)*

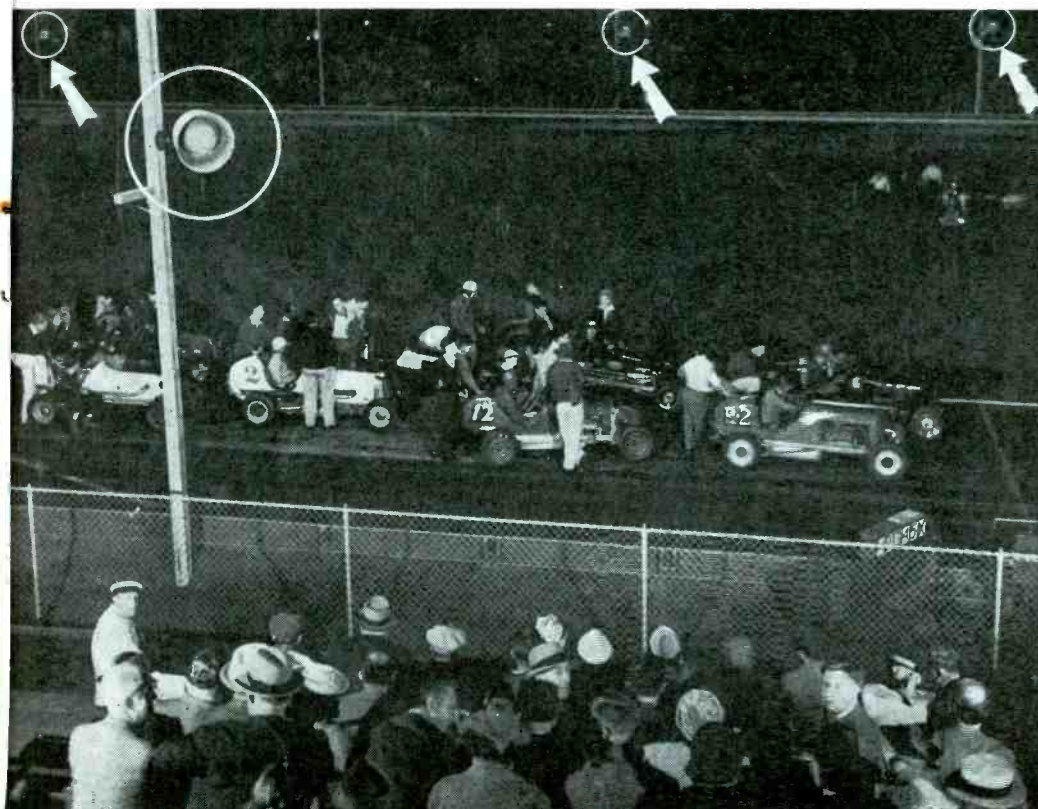

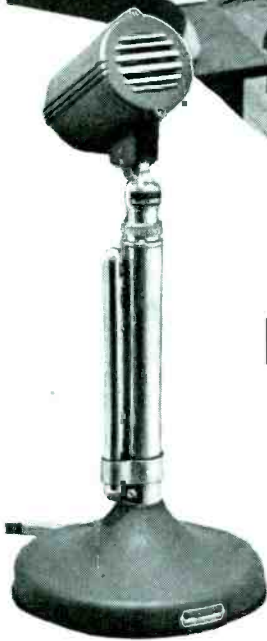
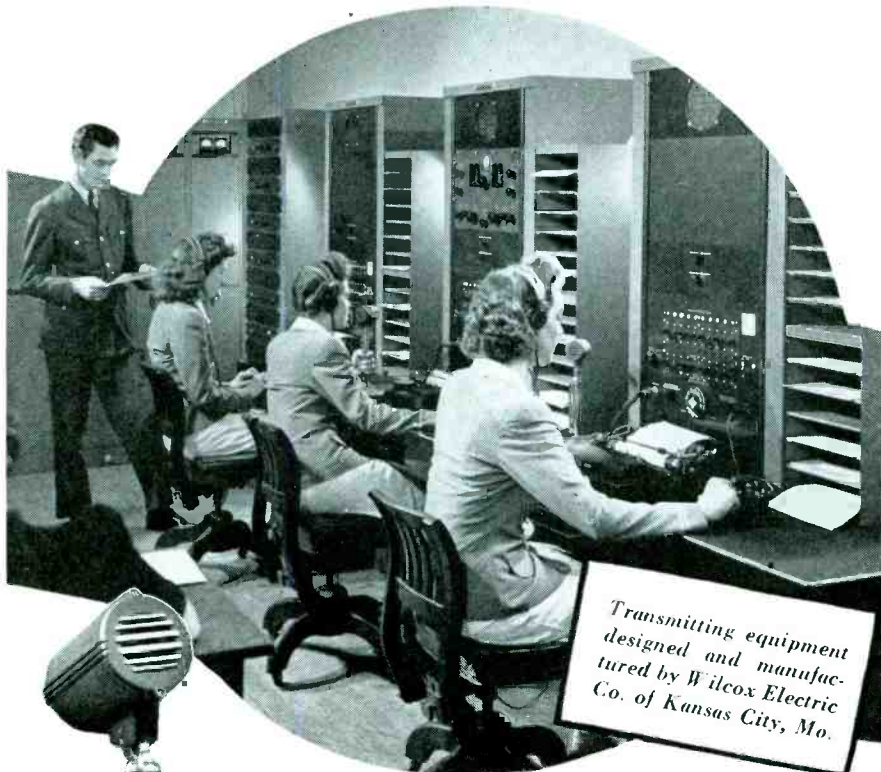

## Important INSTALLATIONS

*Include Astatic Microphones for Long, Dependable Service*

● Astatic Crystal and Dynamic Microphones, long recognized for dependable, efficient service, have many uses and applications. That's why you find them included in

many important installations such as the airline control and dispatching office, illustrated above, public address and inter-office communicating systems, police call stations, recording sets, and other types of modern communication systems. Astatic Microphones and Phonograph Pickups are known and used around the world.

ASTATIC Crystal Devices manufactured under Brush Development Co. patents.

**THE Astatic CORPORATION**  
 CONNEAUT, OHIO  
 IN CANADA: CANADIAN ASTATIC LTD., TORONTO, ONTARIO



### Signs for Stromberg Sets



Charles M. Sherwood, left, Stromberg-Carlson eastern district merchandiser, sees Ben Gross, N. Y. jobber, sign order for firm's radios.

### Sonora "Spot" Campaign

A new and novel spot radio advertising campaign for Sonora radios designed to emphasize Sonora's "clear as a bell tone", was announced by Herbert Summers Hall, vice-president and advertising director of Sonora Products, Inc. The campaign will consist of a series of spot radio announcements in 42 leading cities.

### \$151.50, Lowest Priced Hotpoint Refrigerator

A standard seven cubic ft. Hotpoint refrigerator at \$188, and the lowest priced model at \$151.50, both prices complete, delivered to consumers in any part of the nation, were announced as approved by OPA, by Edison General Electric Appliance Co.

### Bendix Appoints Worth

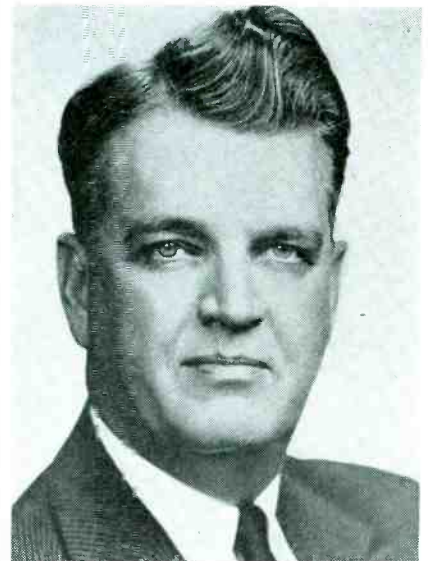

L. F. Worth, who has been named manager of dryer sales for Bendix Home Appliances, Inc.



# Meet Olympic's 1946 Line

## Featuring

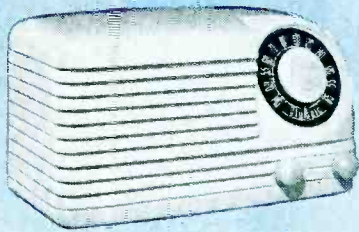

**Model 6-501.** Hi-power 5 tube AC/DC Superheterodyne, 7 tube performance. Streamlined lustrous plastic cabinet, edge-lighted Lucite dial. An unprecedented value.



**Model 6-504.** (AC only.) Table Radio-Phono Hi-power 5 tube Superheterodyne, 7 tube performance. Plays single records. "Permanent" point, feather-weight pack-up. Walnut cabinet.



**Model 6-505.** Superpowered 5 tube AC Superheterodyne featuring exclusive "TRU-BASE." Sleek, modern plastic cabinet. Connections for phono, FM, television sound.



**Model 6-502.** Beautiful cabinet of rich glowing walnut veneers houses Hi-power 5 tube AC/DC Superheterodyne. Edge-lighted Lucite dial. 7 tube performance.

'Tru-base'—revolutionary electronic invention that provides console tone in table radios!

Every Olympic AC set has 'tru-base'—an electronic development in the audio circuit so basic it is filed with the U. S. Patent Office.

Unique among table radios and radio-phonographs—Olympic 'tru-base' sets faithfully reproduce all the beauty of rich bass tones plus the crystal clarity of all high notes. Thus, 'tru-base,' even in moderately priced Olympic models, brings you radio reception and record reproduction of a character, quality and fidelity usually found only in large, costly consoles.

Official prices on these sets will be announced immediately following determination of our applications by O.P.A.

Olympic Division of Hamilton Radio Corporation, 510 Avenue of the Americas, New York 11, N. Y.

**Olympic**  
RADIO & TELEVISION  
The only radio with Tru-Base



**Model 6-507.** (AC only.) Superpowered Radio-Phono 5 tube AC Superheterodyne with "TRU-BASE." Plays and silently changes up to 12 records automatically. Rich, functional, modern walnut cabinet.



**Model 6-606.** Hi-power three-way 6 tube portable giving 8 tube performance. Extra selective, sensitive, long distance getter. Handsome leatherette case. Complete with batteries.



**Model 6-506.** Superpowered 5 tube AC Superheterodyne featuring "TRU-BASE." Modern cabinet in rich walnut. Connections for phono, FM, television sound.

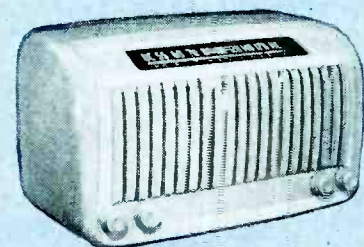

**Model 6-601.** Superpowered 6 tube AC Superheterodyne Broadcast and International Short-wave, plus "TRU-BASE." Graceful, plastic cabinet. Connections for phono, FM, television sound.



**Model 6-602.** Superpowered 6 tube AC Superheterodyne Broadcast and International Short-wave, plus "TRU-BASE." De luxe walnut cabinet. Connections for phono, FM, television sound.

# The Hams Are Back!

**Return of Amateur Radio Fans to "Hamwaves" Means More Equipment Sales; Large Increase in Ranks Seen**

● The amateur radio fans are coming back to the air waves. They are getting ready to resume operation in bigger numbers than ever before in their history—and preparing to spend large sums of money in buying new radio equipment.

The end of the war, together with the release of men from the armed forces and war plants, has sent the hams scampering back to their "shacks" to get their equipment in order. The return of the radio amateur to his pre-war status is good news; good news especially for the manufacturer, distributor and the dealer.

While the hams are marking time until the FCC flashes the green light, permitting them to operate on all of their assigned frequencies, they are getting ready to burn up the air waves.

## **Present Amateur Bands**

On November 15, the FCC gave the go-ahead signal for six months to amateurs holding station licenses valid between December 7, 1941 and September 15, 1942. This order is giving hams a chance to stretch their radio legs and get warmed up for active participation on the "hamwaves."

Under the FCC's direction, amateurs are currently operating on the following frequencies: 28.0 to 29.7 mc, 56.0 to 60.00 mc, 144 to 148 mc (amateurs are not permitted to use the portion between 146.5 to 148 mc within 50 miles of Washington, D. C. or Seattle), 2,300 to 2,450 mc, 5,250 to 5,650 mc, 10,000 to 10,500 mc, and 21,000 to 22,000 mc.

Not only will the hams be returning to their allotted frequencies, but they will also be coming back in droves! The number of amateurs in the "ham army" will be bigger than ever before.

Thousands of ham recruits from the armed forces, and those who increased their knowledge of electronics while working in war plants, are waiting to set up their own

## **Amateurs Will Buy**

### **HOW to Make More Sales to Radio Hobbyists**

1. Encourage Interest in Ham Radio
2. Advertising Aimed at Amateurs
3. Aggressive Merchandising Methods
4. Acquaint Sales Force with Ham Radio
5. Offer Amateurs Any Assistance Needed

### **WHY Suppliers Can Cash-In on This New Market**

1. New Interest in Amateur Radio
2. 120,000 Fans Predicted by 1947
3. Many Hams Have Sold Their Equipment
4. Present Stations Need Modernizing
5. New Apparatus Is Superior to Pre-War

ham stations.

Many thousands of war veterans trained in radar, electronics, and particularly in the communications field, have caught "ham fever." Many of these war vets, in addition to other amateur radio addicts, will be in the market for new radio equipment.

In a sense, many established radio amateurs will be starting from scratch. Immediately after Pearl Harbor, great numbers of hams sold their radio receiving and transmitting equipment to the government. These amateurs sold badly needed apparatus to the Sig-

nal Corps to help win the war.

With "hamfesting" days coming back for the amateurs, they want new and better equipment. Those hams who already have equipment are ready to shell out large sums of money to modernize and revamp their present stations.

Hams want new receivers, transmitters, test equipment, meters, resistors, tubes—plenty of tubes—etc.

Dozens of new types of tubes are available to hams which were not available before the war. Due to many technical improvements, radio amateurs will be able to get much more power from their sets for the same amount of tube cost as pre-war.

The market for new radio parts and for replacement items is a vast one, and suppliers are getting ready for a larger-than-ever business. Amateur radio operators have always been large-volume purchasers of radio parts. It is estimated that the investment which hams currently have in radio equipment runs into many millions of dollars.

## **Receiver Sales Prospects**

Until recent years, most amateurs built their own receiving sets. But when manufacturers produced high-quality sets especially suited for the amateur radio operator's needs, most hams quit making their own receivers. A large market is here for ham receivers, and merchandisers are ready for it.

Many amateur radio hobbyists will probably continue to build major parts of their transmitters in the future. However, the indications show a trend on the part of hams to buy "custom made" transmitters.

In the past, amateur radio has always been a good source of income to retailers and jobbers. If present indications are correct, profits from the sale of goods to hams in the future will greatly surpass pre-war volume.

The dealer can get his share of the amateur market by "getting on

the ham beam." There are several methods which the merchandiser can use to steer this extra profit his way.

For example, distributors and dealers should encourage newcomers into ham radio to develop their hobby. At the same time, buyers and sellers of amateur equipment should urge the FCC to open all the allocated ham channels without any delay.

To cash in on amateur radio interest, as soon as goods become more plentiful, dealers can tap the ham market by aggressive merchandising. For instance, an attractive window display of a ham shack and equipment can stimulate interest in the amateur radio hobby and build sales volume.

For extra profits from amateur radio, the supplier or his salesmen should be able to give hams advice and assistance on technical matters. A knowledge of amateur radio should build good-will for the dealer and additional profits.

#### **Amateur Interest Increases**

Talks with leading distributors of radio parts indicate a tremendous expansion in the number of radio fans who will join the ranks of the hams. These jobbers see a great influx into amateur radio by those who were bitten by the ham bug during the war years.

Prior to the war, about 60,000

The Army's returning Signal Corps personnel will bring new ideas to amateur station operation.



Thousands of young men have been trained in radio communications by Uncle Sam's Navy.

licensed amateur radio stations were keeping the air waves humming with their activities. As soon as the hams are again permitted to go about their business unhampered, experts in the field agree that the aforementioned number should become considerably larger.

Exactly how large the ham ranks will be is hard to predict. But many jobbers feel that the number of licensed operators should be at

least 120,000 by the end of 1946—provided they are given full encouragement by the FCC.

Many of those who are well acquainted with the "ham business" agree that the rate of increase in the number of amateur radio operators, and the amount of radio goods they will buy, depend on these three things:

1. FCC licensing policies.
2. The availability of receiving and transmitting parts.
3. The speed with which the amateur radio channels become accessible.

FCC licensing and examination policies will be a factor in deciding the number of hams who will be permitted to go on the air. Examinations may prove to be a stumbling block to some who want to be amateur radio fans. However, many amateur radio hobbyists, especially those who studied radio communications in the armed forces are well "up" on radio theory and code.

#### **Hams Await Equipment**

Until the FCC throws open all the available channels, the development of the ham radio hobby will be slowed.

Hams will really get into their stride when radio equipment becomes plentiful. The lack of goods is preventing dealers today from sizing up the amateur market and accurately gauging the potential demand.

However, despite any difficulties

(Continued on page 112)



# Silent Night

*Season's Greetings to Masco jobbers and dealers  
and to all our friends in the industry*

**SILENT NIGHT**

No night service calls for Masco jobbers and dealers! The superbly dependable performance of Masco sound equipment lets them sleep at night . . . knowing that their repeat business from satisfied customers is assured.

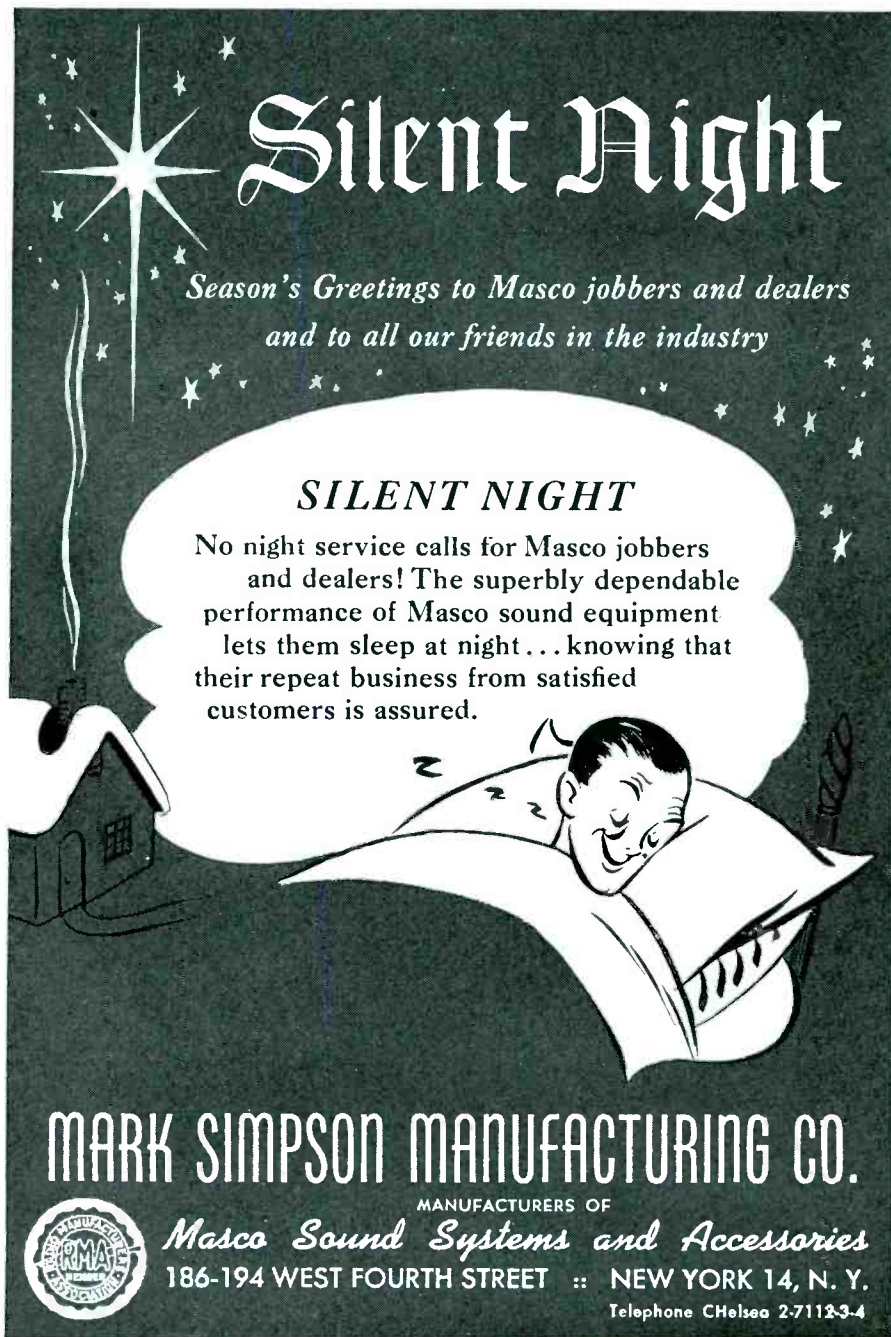

**MARK SIMPSON MANUFACTURING CO.**  
MANUFACTURERS OF  
*Masco Sound Systems and Accessories*  
186-194 WEST FOURTH STREET :: NEW YORK 14, N. Y.  
Telephone CHelsea 2-71123-4

### Named Hotpoint Manager



H. W. Nagel, appointed Chicago sales district mgr., Edison General Electric Appliance Co.

### Blackstone Washer Models Ready for Distribution

Two models of Blackstone washers, the Model 130, deluxe wringer washer, and Model 132 washer, are now coming off the production line of the Blackstone plant at Jamestown, N. Y.

The Blackstone Model 132 has a family size, triple-baked enamel tub. It is equipped with the Blackstone Hi-Vane aluminum circulator, Lovell wringer.

Soon to start in production is the Blackstone Combination Laundry providing automatic washing, rinsing, drying and ironing in a unit of standard counter height and depth, and 80 inches in length.

### Jobber for General Radio

General Television and Radio Corp. announces the appointment of Electronic Distributing Co. as the exclusive distributor for General radio in Cook and Lake Counties, Ill., and Lake County, Ind.

Sam Auerbach heads the newly organized distributing company located at 3162-64 N. Elston Ave., where advance models of the General radio line are on display.

### To Emerson Jobber's Post



Irving J. Sarlin, appointed sales manager of Emerson-New Jersey, Inc., according to an announcement by Samuel Gross, president.



## FREE TO YOU

### COLOR CODE AND OHMS LAW CALCULATOR

A great convenience. Easy to work. Solves many problems. Attach coupon to your letterhead. Free to radio men, engineers, etc.

**BURSTEIN-APPLEBEE COMPANY**  
1012 McGee, Kansas City 6, Mo.

Send me FREE Color Code and Ohms Law Calculator along with latest catalog

I am \_\_\_\_\_  
STATE CONNECTION IN INDUSTRY \_\_\_\_\_

NAME \_\_\_\_\_

ADDRESS \_\_\_\_\_

TOWN \_\_\_\_\_ STATE \_\_\_\_\_

Mail Coupon Now

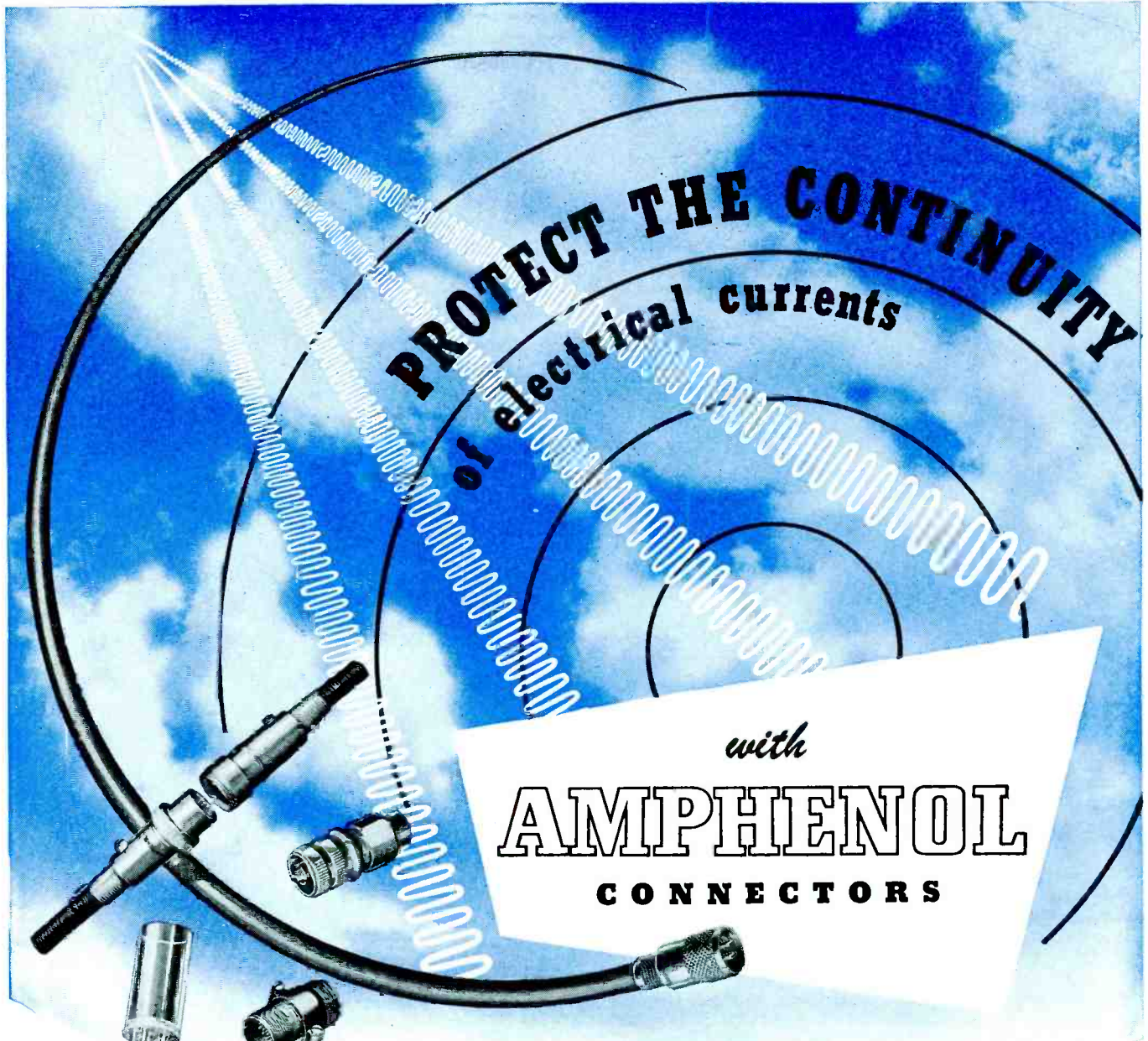

**PROTECT THE CONTINUITY**  
*of electrical currents*

*with*  
**AMPHENOL**  
**CONNECTORS**

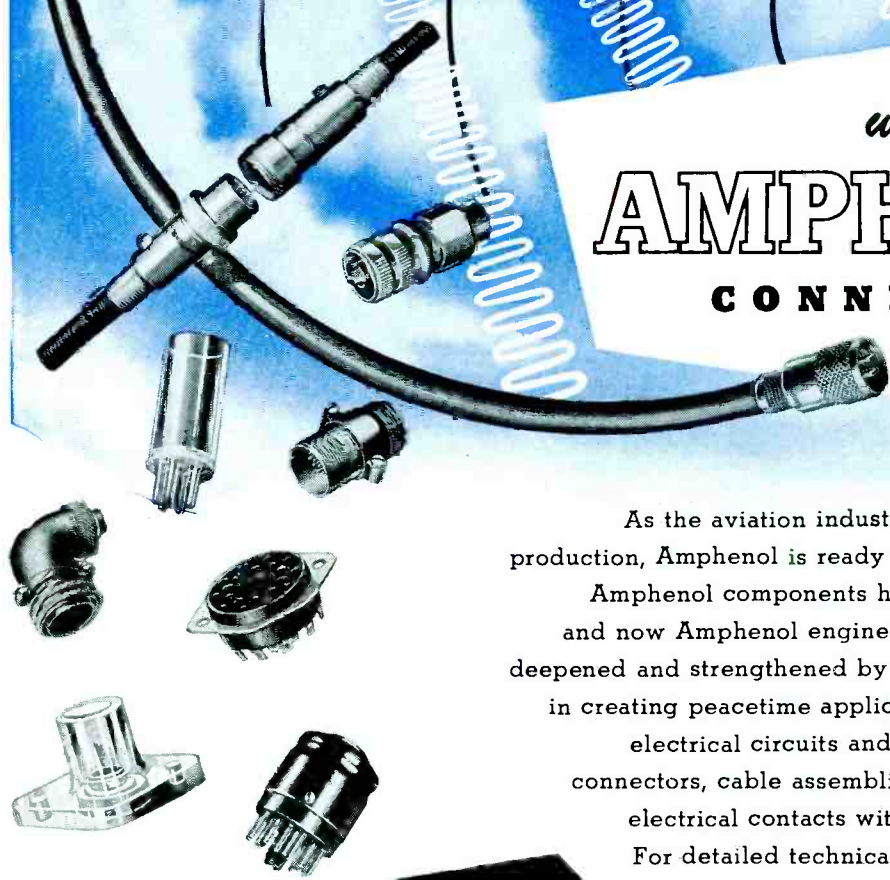

As the aviation industry again swings into peacetime production, Amphenol is ready to offer practical aid in many forms. Amphenol components helped to fight a winning war . . . and now Amphenol engineers with their "know-how"—deepened and strengthened by wartime experience—are cooperating in creating peacetime applications for aviation communications, electrical circuits and electronic controls. Amphenol connectors, cable assemblies and other parts provide positive electrical contacts within all types of equipment. For detailed technical data on Amphenol products—send for Condensed Catalog No. 72.

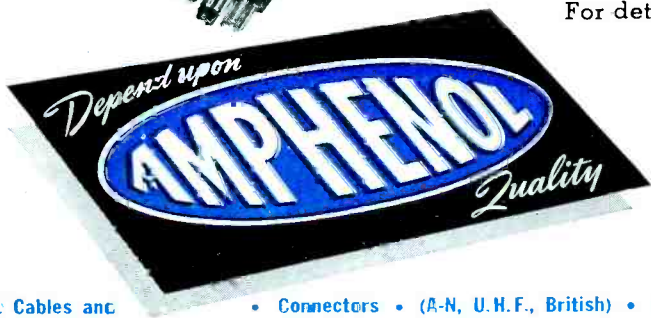

AMERICAN PHENOLIC CORPORATION  
 CHICAGO 50, ILLINOIS  
*In Canada • Amphenol Limited • Toronto*

U.H.F. Cables and • Connectors • (A-N, U.H.F., British) • Conduit • Cable Assemblies • Radio Parts • Plastics for Industry

## Service Notes

### Trimmer Capacitor Alignment

Before making any adjustments on the trimmer capacitor screws located on the gang capacitor, it is helpful to mark the original position of the screw head. This will



facilitate return of the screw to its original position, if this is desired. A black crayon may be used. If there is no suitable place adjacent to the screw head, a mark may be made on an adjoining shield can, as illustrated.

### Repairing Open Field Coil

Speaker field coil openings may be repaired without much difficulty



when the break is near the start or finish of the winding. To determine if this is where the open has occurred, the coil insulation should be carefully removed, layer by layer, until the point of attachment of the lead wires is reached (see illustration). When the open has been found, the extra turns of disconnected wire may be discarded—provided, of course, that only a few windings are involved.

### Reading Schematics

A magnifying glass of the type illustrated can be used to advan-

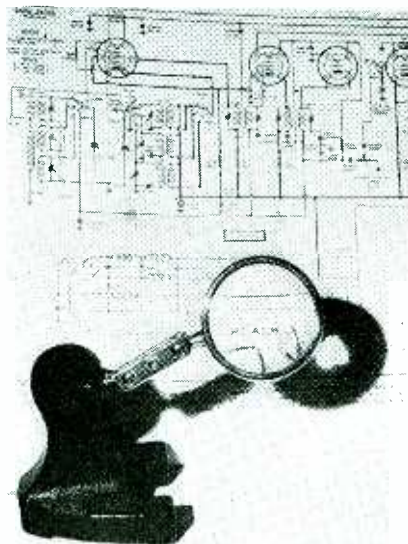

tage with many radio diagrams. Slight blurs or smudges on the schematic may make certain values or markings very difficult to read accurately without a glass.

### Auto Radio Tool

Shown in illustration is an aligning tool ordinarily used to adjust trimmer capacitors. This instrument also makes an ideal tool for turning the variable capacitors of car radios when the dial cable is disconnected. It is insulated with fibre, and the end inserted in the radio has a thin steel blade which fits in the gang capacitor slot.

The tool is also conveniently used in the car after the radio has been connected, and when it is necessary to turn the gang capacitor to the desired position preparatory to inserting the dial cable. ➤

### Adjusting Grid Clip

Imperfectly fitting grid clips may cause intermittent hum and distortion. Proper adjustment may be made with long-nose pliers, as



shown in photograph. Enough tension should be present so that clip makes good contact with grid cap of tube. Too much tension may result in the pulling loose of the grid cap when the clip is removed.

### Capacitor Bank

Substitution tests of suspect radio capacitors are easily made if a number of units with different capacitances are available. An old power supply type of bank is shown in illustration. Modern capacitors

*(Continued on page 118)*

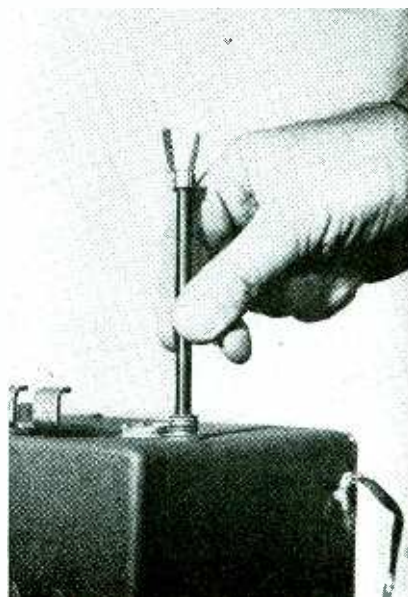

*Look at these 3*  
OF 23 ARVIN VALUES

**ARVIN**  
*Top Flight*  
**RADIOS**

**LOOK**

**AT THE SPECIFICATIONS  
AND LOOK AT THE PRICES**

● **VALUES LIKE THESE** can come only from a well-established manufacturer with the resources and facilities for mass production of Noblitt-Sparks Industries . . . an experienced organization with the proved ability to build top flight quality in low-priced merchandise.

● **VALUES LIKE THESE** make it possible for your customers to buy Arvin radios for upstairs, downstairs and all through the house . . . multiple sales that mean more profit for you.

● **These Arvin Top Flight Values** on their way to you are typical of the many others to come—fine floor and table radios and radio-phonographs, AM-FM, battery sets and three-way portables.

● See them at the Furniture Show  
American Furniture Mart  
666 Lake Shore Drive, Chicago, Ill.



**MODEL 444**

Operates on AC or DC  
Non-breakable cabinet with mar-resistant brown enamel finish. Size 6½" wide, 5¼" high, 4" deep . . . Four tubes including rectifier and two dual purpose tubes. Superheterodyne with 2-gang condenser. Standard broadcast. Direct-drive tuning. Enclosed back. Hank antenna extends 20-30 feet. This remarkably fine set with its trim lines and compact design will ring the cash register at

**\$10.40**

Ivory Finish (Illustrated) \$10.55



**MODEL 544**

Operates on AC or DC  
Attractive molded plastic cabinet in walnut finish. Size: 9½" wide, 6½" high, 5½" deep . . . Five tubes including rectifier and two dual purpose tubes. Superheterodyne with 2-gang condenser. Standard broadcast. Illuminated, easy-to-read dial, built-in loop. 5" permanent magnet speaker. Top flight performance and cabinet beauty that make multiple sales at approximately

**\$15.40\***

Ivory Finish (Illustrated) \$16.40

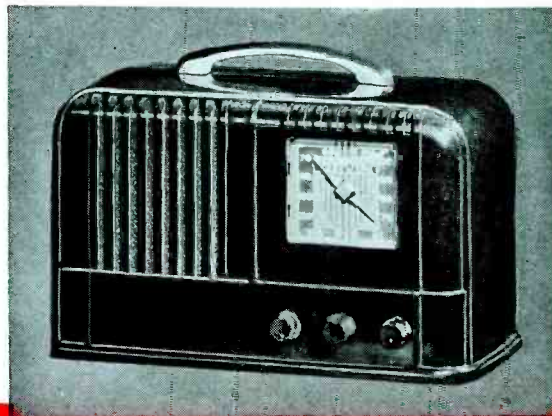

**MODEL 664**

Operates on AC or DC  
Beautifully styled walnut plastic cabinet, bottom-loading chassis, convenient handle. Size: 12½" wide, 7¼" high, 7" deep . . . Six tubes including rectifier and two dual purpose tubes. Superheterodyne with 3-gang condenser, full RF stage and audio-frequency correction. Standard broadcast. Vernier tuning. Continuously variable tone control. Built-in loop. 5" permanent magnet speaker. An extremely selective and sensitive radio. Big set quality with small set convenience and unequalled price-appeal at approximately

**\$24.95\***

Ivory Finish \$25.95

\*PRICES SUBJECT TO FINAL OPA APPROVAL. ALL PRICES SLIGHTLY HIGHER IN FAR WEST.

**NOBLITT - SPARKS INDUSTRIES, INC., Columbus, Indiana**

## Service Notes

### Superhet Changed to TRF in Two Minutes

This superheterodyne set had been tampered with by the would-be mechanic who owned it. The IF coil had been removed. The owner's little boy had found it, and thrown it down the incinerator. No identical or even similar replacement was available at any of the parts supply houses. The owner was not fussy. "Just make it play," he pleaded. The radio-man removed the grid-cap from the 78, which was being used as an IF amplifier, and placed it on the 6C6, the detector, cutting out the entire IF stage. With a bit of tuning, and several minor repairs, the set worked quite well as a TRF. The actual conversion took less than two minutes. No changes had been made except the ones described. When the coil became available, it would be perfectly simple to convert the set back to superheterodyne use.

### Insulation Repair

Many refugees from the junk heap are still being used as radios, due to war-time conditions. On some of these museum pieces, the insulation on leads issuing from huge chokes or condenser packs may wear off, causing shorts between them. The figure shows that if the insulation wears off near

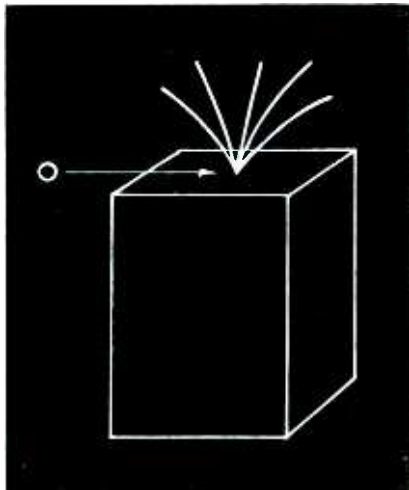

point o, the wires cannot be changed, protected with spaghetti, or taped. A good way to prevent shorts from developing between the leads is to melt wax from a discarded electrolytic over them, impregnating them thoroughly. A soldering iron may be planted in the wax of the electrolytic, which is held over the area to be impregnated, and allowed to drip.

### Television Reflections from Airplanes

A question frequently asked is: Why can an airplane flying overhead at a speed low compared with a television signal (say 250 mph against some 650 million mph) produce such a violent signal fluctuation in a television receiver. This phenomenon is a direct visual illustration of the same basic principle used by radar: the remarkable degree to which ultra-high-frequency waves are reflected from any objects near the path between transmitter and receiver.

#### Two Signals Add

Referring to the diagram, the condition is as follows:

A plane is flying at a height  $h$ , which is usually a small part of the direct separation distance  $d$ , between the transmitter and receiver. Here two signals can reach the receiver—the second signal being reflected by the plane. If these signals arrive in phase the total received signal is augmented. However, since the plane is moving, the second path is continually changing in length—one instant the reflected signal adds to the normal value and the next instant it subtracts. At say 240 miles per hour a plane may move through about 21 wavelengths of the signal per second if plane and signal directions are parallel. This fluctuation would certainly be too fast to be noted by eye, if the radio equivalent of the Doppler effect held.

However, the actual path length over the reflected path is equal to the sum of that from the transmitter to the plane ( $d_1$ ) plus that

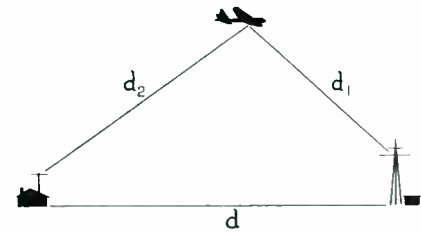

from the plane to the receiver ( $d_2$ ). If the plane is over a point between these locations,  $d_2$  is increased at approximately the same rate that  $d_1$  decreases (or vice-versa if the plane is moving toward the receiver). If the sum of  $d_1$  and  $d_2$  remained exactly a constant, a ghost image and not a fluctuating picture would result.

#### Varying Signal Strength

When the plane is over territory between the stations, but not necessarily moving in the same line as the television signals, the common effect is that the total combined path  $d_1$  and  $d_2$  creeps up one or loses out one wavelength at definite intervals along its path. A varying signal strength is received therefore which causes more or less violent fluctuation of picture intensity.

The signal fluctuation rate may change over wide limits, depending on the speed, height, and the direction of the plane.

More Service Notes on Pages 90, 108

### Capacitor Clips Make Bridging Tests Simpler

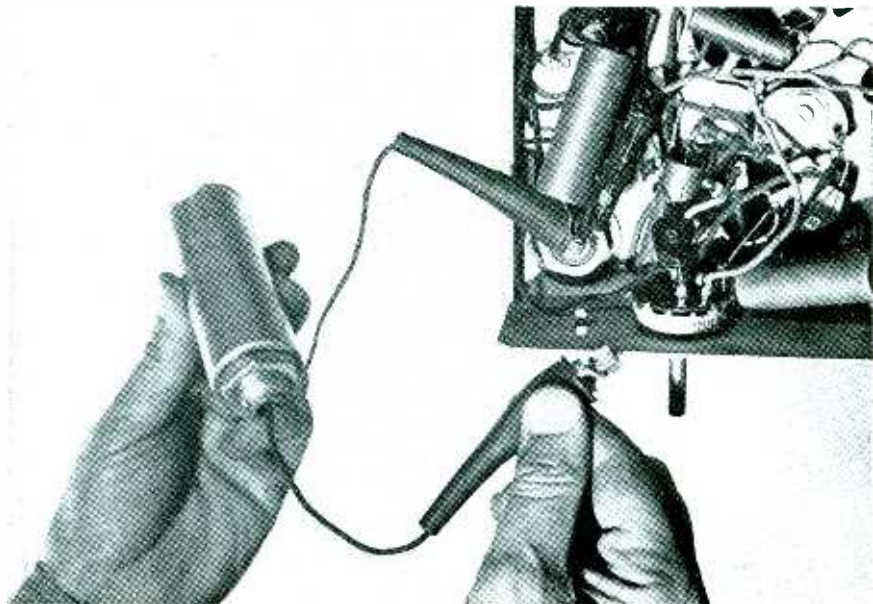

Addition of clips to capacitor leads facilitates bridging tests. These clips are especially useful when several troubles, among them an open capacitor, are present.





# THEY'RE RADIO-ENGINEERED



*That's Why RCA Batteries  
Will Outsell All Others!*



**T**HE RCA radio battery line, streamlined to 35 Preferred Types, satisfies the requirements of 99% of all battery-powered radio sets. With your help, RCA batteries will outsell all others.

Built to radio standards, specifically for use in radio sets, RCA batteries are designed to give your customers more listening hours per battery dollar. Tell *that* to your customers and watch them buy!

RCA, with a quarter of a century of radio

experience, is the best-known name in radio. And that name is working for you!

The RCA seal on your radio batteries is a guarantee of public acceptance, of public confidence, of public demand.

Listen to  
"THE RCA SHOW," Sunday, 4:30 P. M., EWT  
NBC Network

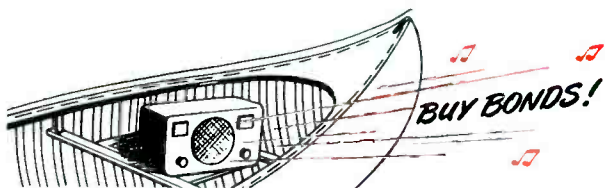

62-6736-109

**RADIO CORPORATION OF AMERICA**

TUBE DIVISION • HARRISON, N. J.

LEADS THE WAY... In Radio... Television... Tubes...  
Phonographs... Records... Electronics

# HAMS

(Continued from page 105)

with which the ham may be faced in the future, it is becoming apparent that the ranks of the amateurs will grow. Also, that with this increase will come a great new demand for radio merchandise.

Amateur radio fans face a great future. Their prestige and knowledge have made great strides since the days when they first "tinkered" with radio.

Hams have come a long way from the time when they first used spark transmitters, and their own initials for call letters. In fact, at the present time, the radio amateur is no longer an "amateur" but is really an expert in the field of radio communications.

Many instances are on record where amateur radio enthusiasts have performed great public services. In the past, these fans have also made important contributions to technical knowledge.

Their return to the air waves is welcome news for the industry as well as for the public.

## Gauthier's

(Continued from page 67)

chandise—both husband and wife must be brought into the store.

To give the establishment a "masculine touch," Gauthier handles a large line of hardware, paint, etc., and other goods which, to a large extent, are bought by men.

In addition to building much store traffic which results in many sales of major appliances, the store has found the sale of housewares and hardware to be very profitable, and finds that these newly-added lines tie in very well with radio-appliance sales.

### Double-Barrelled Appeal

Carrying the "masculine-feminine appeal" even further, the store has devoted one of its windows to a display of goods which stop men passers-by. The other window, carrying a display of electrical appliances, is aimed at attracting women.

The store's window arrangement is unusual—and very effective. The base of the window displays is on the same level with the rest of the establishment, thereby making the goods shown in the windows an extension of the floor display.

On both sides of the store are

shelves and cabinets displaying traffic items. A profit-winning feature of this, however, is that these displays are extended into both display windows. Thus the shelves and cabinets are also put on "outside" display.

The value of in-store displays easily seen from the street has been proved many times. Very often customers will ask for goods shown in the interior of the store which were seen from the street.

### Display Vital

The store makes it a "must" to exhibit at least 90 per cent of the merchandise it carries. "Customers must see the goods in order to buy them," Gauthier declared. "That's why we put on display as much merchandise as possible."

"Not only can all our merchandise be easily seen, but everything carried in the store can be picked up and handled by the customer. More sales are made when the purchaser can feel the goods and can examine them at close range."

To permit all the merchandise in the store to be handled by customers, new display shelves and bins were recently added to the store.

Previously, many traffic items were placed behind counters. This forced customers to ask salesmen to show them goods in which they were interested. Converting part of the store into a self-service department has saved the floor space as well as increasing sales volume.

### Store Division

The rear half of the store is used entirely for the display of radios and electrical appliances. To reinforce its policy of aggressive appliance selling, the firm will have a model kitchen on display. A home-like atmosphere will be provided by having a dummy window, complete with curtains, as part of the display.

To get more profits from appliance selling, the firm will:

1. Maintain prices.
2. Avoid high pressure selling.
3. Refrain from making price the most important issue of a sale.

A large service department for radios and electrical appliances is located in the basement. A staff of eight technicians is employed for the maintenance and complete overhaul of sets and appliances.

In view of the fact that as many as 200 radio and appliance units are in the store at one time awaiting repairs, Gauthier has installed an

efficient method of keeping track of maintenance work.

### Service Important

To back up sales of radios and electrical appliances, Gauthier is prepared to give fast and efficient maintenance work. The firm will give one day service, if possible.

The store is advertised six days a week in the local newspapers. Three to four per cent of the sales volume has been found to be about the right amount to spend for ads.

"Sell customers merchandise which will do the best work for them, assure them of good service work, and you can bet they will be good "repeat" buyers for a long time to come," Gauthier stated.

## PROFITS in SERVICE

(Continued from page 59)

work for merchandising all during the war period," these retailers have stated. "Now that goods are here, we've speeded up our efforts to get on the best of terms with our customers." These dealers believe it is a sound policy to go "out of the way" to please prospective buyers.

Listed on the firm's expansion program is a branching out into wholesaling radio parts. According to the proprietors, service dealers in neighboring towns have an insufficient supply of set components. In view of this, the dealers propose to set up a parts distributing organization offering a delivery service within a 70 mile radius of Springfield.

Janes and Dashney have declared that they will go after business—both sales and service—with a great deal of energy. Their plans call for establishing the store as the radio headquarters for the community.

Every effort is made by the dealers to impress customers with the "professional" nature of radio maintenance "Good Service" is the firm's motto, and these retailers make certain that their customers are aware of this.

The firm feels that it has built a fine reputation during the war period, but it is not content to let the matter rest there. "Radio merchandising will get tougher in the future," Dashney asserted, "and we are covering ourselves by continuing to give our customers speedy quality service and a smile with every purchase."

**HECK! EVERYONE WANTS A PIECE OF THE PIE!**



Yes sir, we are on the spot. We are in the embarrassing position of the unfortunate gentleman trying to cut from one lone pie enough generous pieces to satisfy everyone. Ration it, did you say? Give each one at least a small piece? That is what we are forced to do.

Despite increased productive facilities, it is not possible to cope immediately with the combined jobber and initial equipment demand for Hytron receiving tubes. So we are retaining a wartime solution — rationing. Hytron receiving tubes are being allocated to both jobbers and manufacturers as equitably as possible. Jobbers in turn will allocate just as fairly to Hytron dealers.

In general, we believe jobber demand for

AC-DC and other fast-moving types is easing a bit. It is quite possible, however, that these types may become shorter as equipment demands become more insistent. In terms of types, the shortage will probably continue for several months. After the first of the year, some of the older replacement types should become available in limited quantities. The very old replacement types, we believe, will appear much later.

If we do not always come through with as large allocations as you would like, please try to understand the dual dilemma of demand we face. It is an inadequate pie for so many hungry customers. But we will do the best we can to keep everybody happy.



OLDEST MANUFACTURER SPECIALIZING IN RADIO RECEIVING TUBES

**HYTRON**

**RADIO AND ELECTRONICS CORP.**

MAIN OFFICE: SALEM, MASSACHUSETTS



# Those OPA Pricing Orders

New OPA regulations are designed, among other things, to accomplish the following:

1. Permit certain radio-appliance manufacturers to raise prices (to jobber or dealer) because of increased factory costs.
2. Reduce profit margins to jobbers and retailers to absorb allowed increases to manufacturers.
3. Keep consumer prices at about former levels.
4. Prohibit retailer from demanding "trade-in" from customer as a condition to selling customer a new radio.
5. Wipe out certain "inequities" seen in out-of-line high ceilings previously granted by OPA to certain makers of "loft" sets.

Under present conditions retailers may temporarily earn as much or more profit as before, since, as OPA points out, they won't have to make profit-taking "concessions" in order to make sales.

But OPA should ready itself to revamp the regulations the moment production reaches the point of supplying even a fair portion of the demand as such condition might bring about a return of the severe type of competition we formerly had.

## Why Not a Price "Floor"?

Perhaps one of the things OPA could do if and when severe competition returns (and OPA is then in existence) would be to put a "floor" on radio-appliance merchandise prices as well as a "ceiling." (The technique employed by most state, fair trade acts.)

While it is true that manufacturers' costs have risen, and that they certainly deserve the increase they received, it is equally true that jobbers and retailers preparing to receive goods after years of famine, are experiencing greatly upped operating expenses due to personnel increases, high transportation costs, modernization, etc.

Certainly, therefore, dealers and jobbers, willing to work on shorter discounts at this time, will not be able to work on such cut margins in a highly competitive market such as we had before.

## Rule Should Work Both Ways

The "trade-in" provision is designed to protect the consumer. Formerly, the dealer was the "goat"—the consumer held the whip-hand, shopping around for the highest trade-in offer. It would seem to us that OPA should have included a clause in the new orders prohibiting buyer from demanding that dealer accept trade-in.

## Not Buying Those "Loft" Radios

OPA worries needlessly over the "loft" radio proposition. The ridiculously high prices it gave out to be tagged on such "dogs," coupled with unknown brand names, have prevented their successful sale. A shopping tour around one large city has convinced us that the "junk" is not being bought in large quantities.

Perhaps, after all, an increase to list prices of radios and appliances to a never-before so wealthy buying public would have been a contributing factor to inflation, as OPA asserts. But looking back at the costly delay in getting out pricing schedules, many feel it would have been the more economical and more beneficial plan.

## ABOUT INJUSTICES TO THE DEALER

The OPA, we must remember, is holding the line against the rising tide of inflation.

For that effort it deserves the thanks of all good citizens. An inflationary vicious circle of price rises could work untold injury to us all.

But OPA's methods in combating the inflation menace have unfortunately been chiefly at the expense of the retailer—the one factor least prepared to stand the cuts.

Manufacturers did well during the war years. Distributors, too, found ways to serve the nation and to prosper.

But few are the dealers who even kept abreast of expenses from '41 to '45, despite every recourse to economies, servicing, and wartime lines.



Now, retailers as a group are being charged by OPA with having given away their margins before the war. In such charges we see evidence that OPA's investigators have been influenced too greatly by big-city conditions. Whatever the evils of such metropolitan merchandising—dealers in the small towns have always recognized the need for their full margin. Such "regular" dealers, who have sold aggressively but carefully and soundly, should not now be made to sacrifice because of the margin-cutting practices of city outlets.

For before long a buyer's market will be with us again. Then—to do a job and serve the public—the retailer will need to utilize every cent of the full margin that trade practices have long allowed him.

By that time, we pray, the OPA will have recognized and removed its present injustice to retailers—or perhaps itself will have folded up its job all done!

THE EDITORS



Your IRC Distributor is now prepared to furnish you with all of the many types of resistance devices you most frequently need in your electronic servicing and installation work.

Months ago IRC made plans and preparations to provide you with ample quantities of quality controls and resistors immediately civilian restrictions were eased or abolished. Today, the results of those plans can pay off in added profits for you.

### ***Every Cataloged Item in Stock***

Every item shown and described in IRC's new Service Catalog No. 50 is now either on your Distributors' shelves or can be obtained for you practically over-night. This is possible because of newly created Servicemen's Stock Room recently set up at the IRC plant. That this stock will be kept well supplied is assured by IRC's tremendous production capacities which were stepped up to an all-time high to meet heavy war quotas.

If you do not have your copy of the new IRC Service Catalog No. 50 get one from your Distributor today or write direct to Dept. 21-L.



## **INTERNATIONAL RESISTANCE CO.**

**401 NO. BROAD STREET • PHILADELPHIA 8, PA.**

*-IRC makes more types of resistance units, in more shapes, for more applications than any other manufacturer in the world.*



# Sell the make all homes know best!

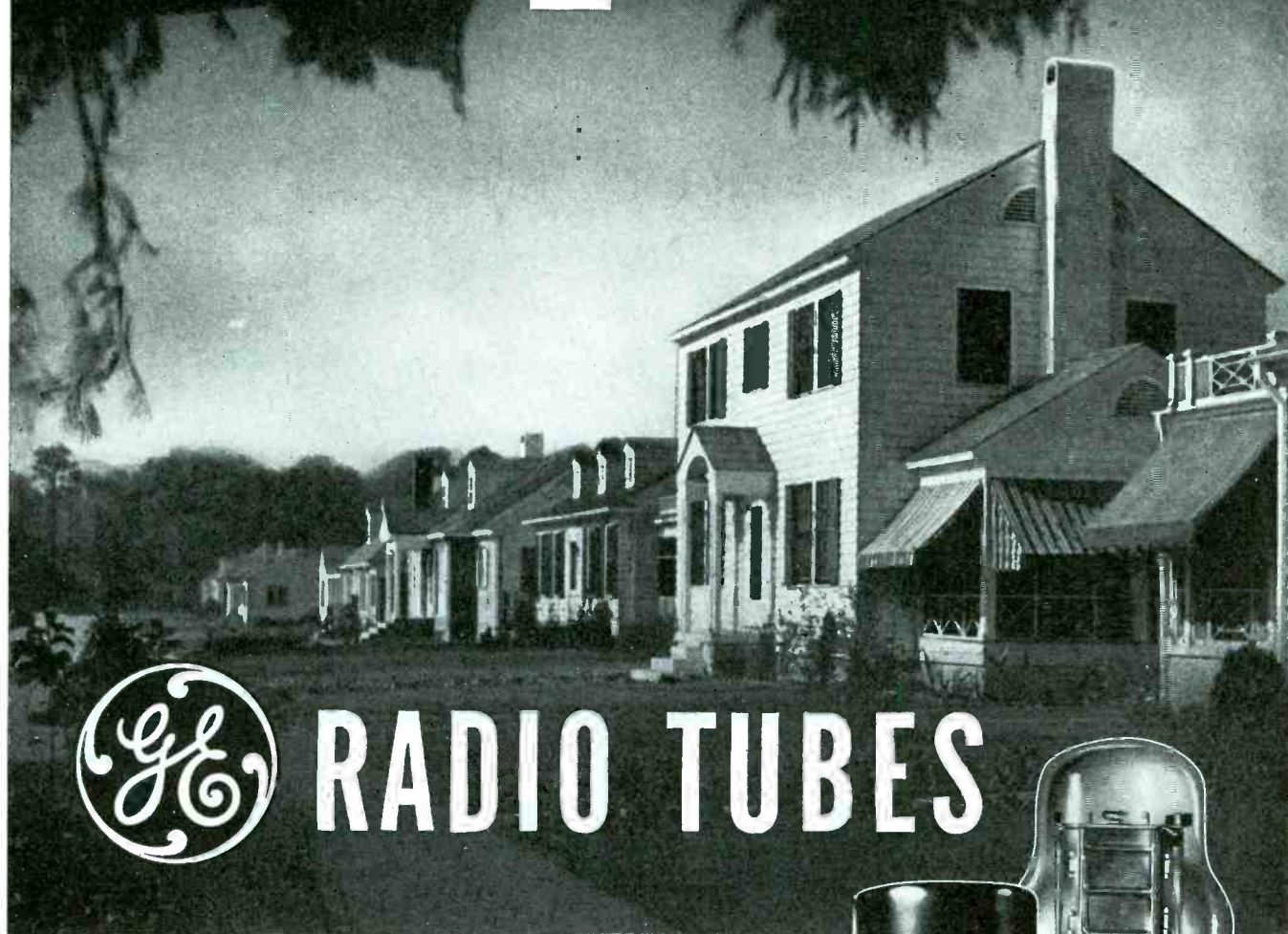

## RADIO TUBES

**G**ET OFF to a fast start by selling G-E radio tubes. Every home-owner knows and respects the famous G-E monogram—gives a friendly welcome to products bearing that symbol. G-E radios, lamps, refrigerators, and other appliances—one or more are sure to be in dependable daily use, building preference for tubes made by General Electric.

● G-E radio tubes are advertised in national magazines with a total circulation of 30,000,000; also over the air to 7,000,000 radio homes. User preference *plus* strong advertising make the G-E tube franchise a top profit-producer. Investigate this opportunity. Write for information about G-E tube selling rights to *Electronics Department, General Electric Company, Schenectady 5, N. Y.*



Hear the G-E radio programs: "The World Today" news, Monday through Friday, CBS. "The G-E All-Girl Orchestra," Sunday, NBC. "The G-E House Party," Monday through Friday, CBS.

# GENERAL ELECTRIC

176-De-8950

## AI's Radio

(Continued from page 53)

sales stimulator. The firm feels that the money invested on this fixture will be well spent after receivers are available in quantity.

To prepare for future television set merchandising activities, the store prominently displays the word "Television" in the radio department. Even today, the store's owners have declared, "Television" is a "magic word," and these dealers intend to cash in on video interest right now.

One of the most outstanding features of the street-level department is the radio "service bar." Constructed of birch plywood, this attractive service department "hits 'em in the eye" the moment customers enter the store.

About \$1,000 was spent in building the "bar." The cost, in addition, to the prominent location given to the service bar, indicates the importance which Vineglass and Weiner attach to the servicing phase of their business.

These merchants believe that maintenance will figure prominently in future radio merchandising. The co-owners are out to keep servicing on a "paying basis" now as well as in the days to come.

Appliance selling is going to get a great deal of attention from the organization's sales staff. To sell more electrical appliances, the store will have on display in its basement, and in actual operation, a model kitchen and laundry.

An aggressive sales policy is the order of the day to the store's appliance salesmen. A crew of eight outside salesmen will go after business as soon as sufficient stocks make this policy feasible.

### Active Selling

To back up the efforts of the sales staff, heavy newspaper advertising, in addition to a radio program and spot announcements will be used. This organization means "business!" A full line of appliances will be carried by the company.

This establishment believes in signs! To take advantage of its excellent location on one of the community's main streets, two large neon signs, one running horizontally, the other vertically, identify the store from a great distance.

Well-lighted at night, the store appeals to evening shopping crowds. Dealers Vineglass and Weiner are

convinced that appealing outside displays, and an attractive and well-lighted store front are essential to draw traffic into the establishment.

### Profit Combine

Since one year ago, when the company moved into its present quarters, business has been on the upswing. The firm's profit-getting combination of an excellent location, quality merchandise, and energetic sales methods has already brought much new business to the store. "And this is only the beginning," these retailers have stated.

Much money has been spent by the organization in modernizing, advertising, etc., to prepare for the boom merchandising period immediately ahead. The current rising sales volume indicates that the firm's planning is beginning to pay off.

Records, radios and electrical appliances are moving into the store—and moving out as fast as they arrive. The New Year promises to be a banner year for the owners of this firm.

## Detroit Dealer

(Continued from page 43)

isfaction after the sale has been made, the firm maintains a large, well-equipped service department. All makes and types of radios and electrical appliances will be serviced.

The maintenance end of the business is staffed by technicians who are experts in their fields. The firm hopes to build a large sales and service repeat business by giving the customer satisfaction after the item has been sold.

During the war period when the store was relying, to a great extent, on service work for profits, it found the selling of electric fans from its large stock to be very profitable. Merchandising household fans, and fans for office and industrial uses, helped considerably to swell the firm's income.

Lines of fans have been permanently added to the list of products which are sold by the store. Electric ranges and kitchen appliances are also big profit items here.

The Economical Radio & Appliance Co. is ready to boost its sales volume considerably over its best prewar figures. The establishment's sales organization is getting set for

bigger business than ever before while awaiting the arrival of new merchandise in sufficient quantity.

"I'm sure that we will get our share of the profits from selling radios and appliances," said Winn. "We're prepared to give our customers what they want—the latest and best in household appliances. As we are ready to offer quality goods, excellent service, and pleasant customer dealings, I'm certain we'll get plenty of business."

Winn is no newcomer to the radio and electrical appliance field. He has been in the business for the past 16 years, during which time he has had a clientele of about a half-million. But, according to this dealer, the best is yet to come!

## Overhead

(Continued from page 41)

expenses by making a drive to cut down the spoilage-breakage rate which he is forced to charge off to operating cost. Elimination of hazardous conditions which may bring breakage is one step. Insistence that employees exercise greater care in handling merchandise will also help to cut down the breakage rate.

Window-dressers should be required to arrange displays with a view toward preventing merchandise damage from the sun's rays. Electric cords should be removed from appliances, vacuum cleaner bags kept out of direct light, etc.

### Check Small Leaks!

As the dealer goes over his business set-up section by section, operation by operation, he will find many ways to trim costs of doing business. Though many of the items surveyed will be found to represent but small sums, in the aggregate they invariably add up to "respectable" amounts.

Some of the larger potential profit-takers such as "over-board" trade-in techniques, over-stocking of slow-moving lines, etc., are well known to merchants and are therefore constantly under scrutiny and "repair", but many of the "taken-for-granted" or "hidden" unnecessary expenses go merrily along their ways, "tapping" the dealer's till of money they do not earn.

Because of lowered margins and increased expenses today, the dealer should leave no stone unturned in his efforts to root out unnecessary operating costs.

# THIS EYE-CATCHING BURGESS CAMPAIGN

makes 16,000,000 favorable impressions and sells batteries to readers of *The Saturday Evening Post*, *Liberty*, *Outdoor Life* and 21 other favorite magazines!

5435  
HOMER G. SNOOPSHAW

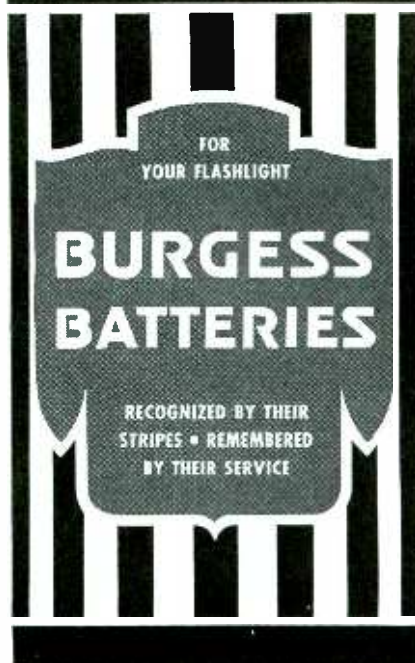

## Service Notes

(Continued from page 108)

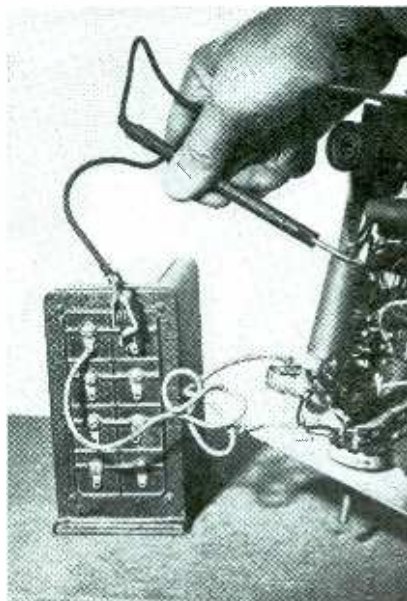

may be mounted in a similar manner. One terminal is common to all the units. A test lead with a clip on one end may be attached to other terminals of the bank.

### On Chicago Rep's Staff

Bruce Cumming, manufacturers' Representative, Chicago, has engaged the services of a radio sales engineer, who has ten years experience in radio as a service man, sound engineer, and in motor control work.

### Republic Sales Manager

Louis Horvitz, president of Republic Distributing Co., Providence, R. I., announced the appointment of Edward H. Lavine, as sales manager and associate. Mr. Lavine was formerly with the Simons Distributing Co. Republic distributes Bendix radios, Quaker space heater, Automatic washing machine equipment, and other traffic appliance lines.

### Sonora Retailers Meet in Pittsburgh



Joseph Gerl, Sonora president, and Howard Dewalt, president of L. H. Smith, Inc., Sonora distributors, greet dealers attending luncheon. Left to right, back row, are merchants Roy Constable, Eli Klein, both of Morgantown, W. Va., and H. D. Krantz, Columbiana, Ohio. Bottom row, left to right, are Mr. Gerl and Mr. Dewalt.

### Clarostat Conference



Left, L. G. Cushing, Chicago sales rep. talks things over with Clarostat sales manager Victor Mucher at a recent meeting in Brooklyn, N. Y.

### Admiral Refrigerators Coming Off the Line

Manufacture of postwar Admiral refrigerators has actually begun in the Admiral Division of the American Central Manufacturing company's plant at Connersville, Ind.

Ross D. Siragusa, president of Admiral, announced that the first refrigerator to come off the line was given to the state of Indiana. Built entirely from new tools and dies, this refrigerator is the result of many months of design and engineering refinement by Admiral Corp. Having acquired the basic system design from Stewart-Warner Corp. in February of 1944 Admiral has completely retooled and restyled the entire cabinet including hardware. The first model to come off the production line was of the conventional type with storage capacity of 7½ cubic feet.

### To Build Sales Outlets

R. E. Krumm, formerly a member of the war contracts department, Frigidaire Division, General Motors Corp., Dayton, Ohio, has returned to the appliance sales department and will specialize in the development of merchandising type dealer outlets, H. M. Kelley, appliance sales manager, announced.



# Just Listen...to Hear the Difference!

ONLY STEWART-WARNER GIVES YOU

**STROBO-SONIC** *Tone*



AND MANY OTHER GREAT NEW FEATURES

Here they come! The exciting fulfillment of Stewart-Warner's 22 years in building fine radios!

And what a difference you can *hear!* Everything that prospects for new sets have asked for, in all-new models . . . Strobe-Sonic tone, super-clear reception, and smart, modern styling. Great new features, too, like the Radair Antenna, the Signal Sentry, and the new *single-control* automatic record changer.

Listen to these new sets just once . . . and you'll *know* the difference!

**NEW CONSOLE COMBINATION**

New beauty of fine cabinet-making . . . amazing new beauty of tone! All-walnut or mahogany. 18th Century antiqued brass hardware. Spread-band dial. Push-button tuning. Tone control. Short-wave bands. Automatic record changer. No-lift top. For the first time in this range . . . *all* the desired features of the most de luxe consoles!



**NEW TABLE PHONO-RADIO**

Tone so real and rich you'd expect it only in a big console! Undistorted *volume* for dancing. Automatic record changer. Sixty per cent more sensitive and receptive than prewar models. Just let them *hear* the difference. It's a new radio experience!

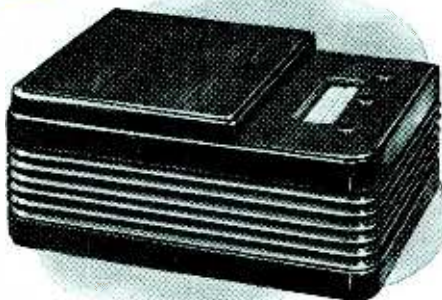

**NEW 3-WAY PORTABLE**

The proved prewar leader . . . now *improved* to keep that leadership! No wet cells! Compact dry batteries can be charged by AC or DC —stops automatically when charged. Up to 50 hours of battery use.



**NEW 2-BAND TABLE SET**

Handsome cabinet designed for living tone quality. New Stewart-Warner features cut static pop and crackle . . . give you virtually "silent" reception! Distant stations come in sharp and clear. Police and short-wave bands. *Just listen* to it!



**NEW PLASTIC MODEL**

Never before has any radio in this price range offered so much . . . lifelike tone that has depth, wide range, and revealing fidelity. The *peak* of small-set efficiency. New postwar plastic design. Hear it *once* to hear the *difference!*



YOU CAN DEPEND ON

**STEWART-WARNER**

*Radios*

CHICAGO 14, ILLINOIS



Radio-Phonographs • FM • Television

Copyright 1945—Stewart-Warner Corporation

## Sound Sales

(Continued from page 101)

sizable profits, provided that costs are accurately figured in advance, and adequate charges thus determined.

Hotels should be an excellent market for piped music systems. Some hotels have a radio-in-every room feature. This generally consists of extension speakers in the rooms, fed by a central radio or record player.

Where a hotel already has a system of this sort, year-round maintenance service may be offered. Where it doesn't, the advantages of such a system may be readily pointed out. No inducements are necessary, of course, to get hotel rooms rented in these days of acute housing shortages. The time is not far distant, however, when hotels will once more be in sharp competition with one another, and piped music installations will serve to either outdo a rival hotel that has no such installation, or else meet its competition if it has.

Dance hall establishments, concert and lecture halls, and churches, all can use PA systems. State or Federal prisons would seem to need inter-communication and PA systems more than other institutions. Dealers who live near waterfronts may look into the possibilities of installing sound systems on ships. Yachts and large pleasure craft of all sorts would seem to be the likeliest prospects.

### Movies Profitable

Sound motion picture installations and maintenance have proved profitable for many dealers. Although many motion picture projector operators can repair the equipment they use, their knowledge of audio amplifiers is usually sketchy, and a difficult job may stump them. A dealer with competent technicians may be able to offer better and faster service on amplifiers than movie projector repairmen, and thus be able to get year-round maintenance work on this equipment.

Some dealers have found it profitable to build and sell high quality PA amplifiers to special clients. Work of this sort requires exceptionally skilled technicians, who are able to design the equipment to be sold. Since these amplifiers are constructed to do one special job better than commercial amplifiers, selling clients on them is not difficult.

There is big money in sound. It is not, however, easily or quickly acquired. Sound offers its rewards only to the unusually enterprising merchant.

To be successful, the sound merchant must, first of all, employ highly competent technicians.

Second, he must advertise on a fairly large scale, and get effective, "punchy" copy for his ads.

Third, he must have good salesmen, who know enough about the technical side of sound to interest and convince potential users.

Given a set-up of this sort, sound profits are inevitable. Few sidelines offer greater financial rewards.

## Store in Store

(Continued from page 39)

shelf, prominently displayed in the radio section of the store. The display has never been large, because the turnover has been so great. However, enough receivers in good repair have been usually available for the day-to-day demand.

Early in the war period, Strom secured a stock of 200 table models plus 25 portable phonographs. Long Beach is a hub of Naval activity stemming from nearby Terminal Island and other service-populated points. As a result, Navy personnel became the big renters of these sets. Radios were rented usually for a period of three to four months, and returned for rental to other customers.

As new radios come on the market, there will, of course, be a drop in the rental business, but Strom is confident that, since the city is near large Naval establishments, there will continue to be a large transitory population interested in rental service. He believes it will continue.

### Service Pays

Radio maintenance, stepped up during the war to a 100 per cent increase over pre-war figures, will be continued. The radio department and receiving room, adjacent to the alley at the rear of the store and convenient for handling sets brought in for servicing, will be renovated and modernized. Final plans for this work are at present incomplete.

The Humphreys Music Co. is ready to meet the large pent-up consumer demand for radios, electrical appliances, and music goods; and ready, too, to make friends with many new customers who are in the market for merchandise.

## Recording

(Continued from page 51)

—Recordings to aid in correcting faults and check progress.

For broadcasting station artists—A permanent record of broadcasts made "off the air."

For ministers and public speakers—Recordings to save your voice. Use instead of personal appearances.

For clubs and civic organizations—Our mobile unit can make recordings of prominent speakers for repeat use.

For advertisers—Transcriptions to carry your message by radio or public address system any place, any time.

Standard recording fees charged by the firm are as follows:

Self-made types:

6½ inch record .....\$5.00  
8 inch record ..... .75

In acoustic studio (professional grade):

8 inch record, single side .....\$2.00  
8 inch record, both sides ..... 2.50  
10 inch record, single side ..... 3.00  
10 inch record, both sides ..... 3.75  
12 inch record, single side ..... 4.50  
12 inch record, both sides ..... 5.25

Charges for professional recordings involving special settings, test records, etc., are determined in each individual's case. Estimates are given on application.

The charges listed also apply to recordings made "off the air," or "on location."

### Operates Laboratory

In addition to this recording studio and radio salon, the company also operates the Lock Radio Shop & Laboratory at MacDill Ave. at Bay-to-Bay, Palma Ceia. Servicing on radios and record players is accepted at both establishments.

Retailer Lock has had long experience as a broadcast engineer. This aggressive merchant has been employed by the FCC as a radio intelligence officer to record enemy radio transmissions. Much of his experience contributed to the development and design of the recording studio's equipment.

"The census is not the only indicator of this city's growth," he declared. "Our organization offers the residents of this area a service which is available mostly in large cities. This business has already achieved a reputation, and is familiar to many persons well known in the broadcasting field."

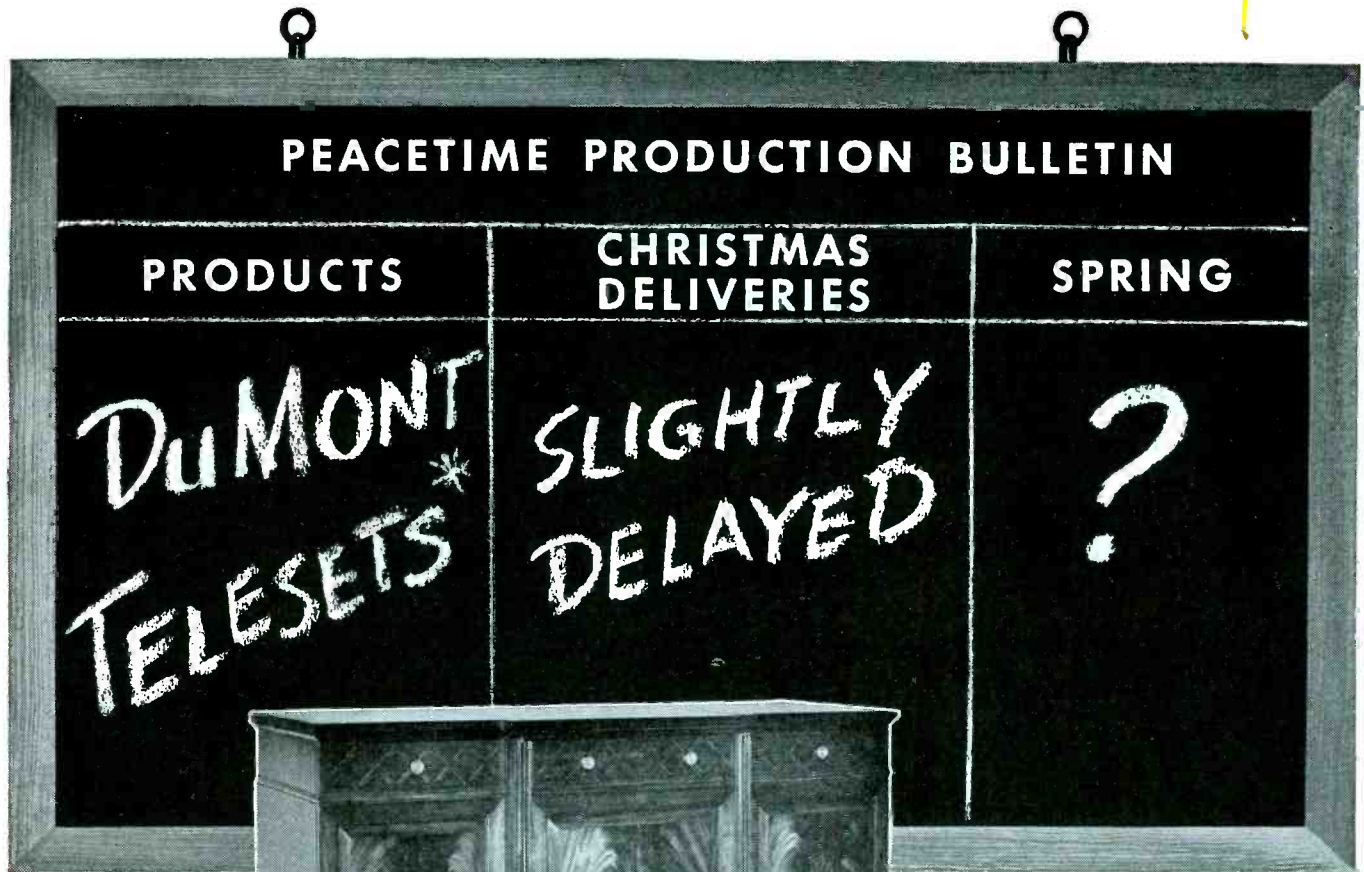

*The DuMont line includes many models ranging from small consoles to de luxe combinations containing TV, AM, FM and short wave reception, high fidelity phonograph, recorder, record changer and album compartments. Modern and period styles, available in a wide price range.*

## MATERIALS SHORTAGE HOLDS UP DUMONT TELESET PRODUCTION

DuMont production schedules called for several hundred fine new DuMont Telesets in *your* hands in time for the Christmas trade.

DuMont engineers, working 24 hours daily, incorporated all wartime electronic advancements into DuMont receiver designs...ran hundreds of model tests...rushed production lines to completion...and pushed work as rapidly as maintenance of DuMont's exceptionally high standards permitted.

Had we not encountered serious delays in shipments to us of component materials, these new DuMont Telesets—the finest, we believe, you will see in 1946—might now be on display in your windows and showrooms. Our pace has not slackened, but we are unable to assure completed sets before Spring. DuMont-engineered quality, however, has the industry thrilled and excited. You will find it well worth waiting for.

\*Trade-mark Reg.

Copyright 1945, Allen B. DuMont Laboratories, Inc.



ALLEN B. DUMONT LABORATORIES, INC., GENERAL OFFICES AND PLANT, 2 MAIN AVENUE, PASSAIC, N. J.  
TELEVISION STUDIOS AND STATION WABD, 515 MADISON AVENUE, NEW YORK 22, NEW YORK

# Television Talk

## Chicago Dealers Meet

To help retailers merchandise the new video receivers, the radio and electrical appliance group of the Electric Assn., Chicago, held television set demonstrations at a recent meeting. The technical and commercial aspects of television were also discussed. Private showings of exhibits to the dealer group were conducted in the Edison Electric Shop.

## "Black Light" Lamp for Tele-Radio Set Use

The Westinghouse lamp division, Bloomfield, N. J., has developed a fluorescent lamp producing unseen ultraviolet rays under whose touch the dial markings of home radio or television receivers are transformed into new, uniformly-glowing colors. Although the "black light" lamp was designed chiefly to improve dial lighting and for radio set beautification, it is expected to find wide practical favor in television where it will cause receiver control knobs and dials to fluoresce with easy visibility and minimum interference with the television image.

## Philco Officials See Speedy Growth of Tele

John Ballantyne, president Philco Corp., in a statement on the 1946 television outlook says:

"Of all the great new industries now on the horizon, none holds richer promise than television. In terms of the employment opportunities it will offer, the new wealth it will create, and the invaluable service it will give to the public, television has no equal.

"Television should advance rapidly in 1946. The FCC has given it the green light, and many new stations should go on the air as soon as equipment can be obtained. Sales of television receivers at first will be limited to those areas where a regular program service is on the air. Then step by step interest will broaden until television is able to visit every American home, wherever located."

Larry E. Gubb, chairman of the Philco board, also issued a statement on television. Mr. Gubb stated:

"It is my feeling that television like any other industry will develop faster and

better when put to use, rather than held back in the laboratory. It will not be many years before practically every family in the United States will have a television receiver in their home just as they have a radio set today. I believe the public will be surprised at the great speed with which television grows."

## Farnsworth Video Antenna



Engineer Virgil Bowman checks remote controlled tele antenna designed for the purpose of eliminating reflected shadows.

## Televise Filter Queen Demonstration



Health-Mor, Inc., held a live demonstration of its Filter Queen vacuum cleaner over station WBKB, Chicago. Albert E. Kramer, vice-president, states that the purpose of the telecast was to compare this form of selling with other methods such as house-to-house salesmanship, etc.

## RCA Telesets \$150 to \$500

Greatly improved by war-time developments, television is ready to go, Dr. C. B. Jolliffe, vice-president in charge of RCA Laboratories, told the Radio Executives Club in New York. All the elements necessary to the immediate expansion of an eminently satisfactory television service to the public have been developed, he said, and there is no technical reason for further delay in welding them into a system that "will give the American public a wonderful new service for which it has been waiting a long, long time.

"We feel confident that we can manufacture direct-viewing and projection-type receivers at prices within the reach of the public in various income groups. The range probably will be from \$150 to \$200 for excellent direct-view table models, to \$500 for the large projection console type," Dr. Jolliffe said.

## List DuMont Tele Tubes

A comprehensive selection of various types and sizes of cathode-ray tubes especially adapted to television reception is presented in a bulletin, "DuMont Cathode-Ray Tubes for Television," just issued by Allen B. DuMont Laboratories, Inc., of Passaic, N. J. The bulletin illustrates and lists several 5", 7", 10", 12" and 20" tubes of both the electrostatic and the magnetic deflection categories, together with the more significant characteristics. It also announces a 15" magnetic deflection tube now in development stages. In each instance the useful picture area is given. A copy of the bulletin may be had for the asking.

# watch Sonora go places!

RBU 207: Big dynamic speaker, advanced styling, full-view slide-rule dial, and outstanding tone quality make this 5-tube AC-DC walnut table model sure-fire for sales!

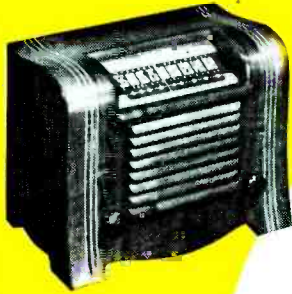

RCU 208: 6-tube AC-DC superhet table model, in smart walnut cabinet. Newly perfected patented chassis circuit gives big set reception!



RHF 213: Graceful walnut cabinet lends distinction to this 5-tube AC table model radio phonograph. Large dynamic speaker. Featherweight crystal pickup. Permanent needle. A whale of a value!



# Sonora's telling the World...

“ ABOUT EVERY SONORA RADIOS’

# Clear as a Bell tone

Powerful, dramatic Sonora advertising works away day and night building a backlog of demand for Sonora dealers by telling the world about the famous Sonora tone that's "Clear as a Bell." It's bold, straight-from-the-shoulder advertising that makes sense . . . and makes customers!

#### Advertising That Reaches Millions

Sonora magazine and newspaper advertisements—big and challenging—are selling the readers of the nation's most important publications. The most intensive spot broadcast advertising campaign in the entire industry hits home in homes all over America. And a complete dealer plan of displays, literature, mailing pieces, and local cooperative advertising helps Sonora dealers tie in with Sonora's national prestige.

It's advertising that's sure to mean business—good business—for Sonora dealers everywhere! SONORA RADIO & TELEVISION CORP., 325 No. Hoyne Ave., Chicago 12, Ill.

#### THE RADIO QUESTION OF THE MONTH

Asked by Sonora Dealer Jack M. Winer, Dynamic Electronics — New York, New York City

Answered by

Mr. Joe Gerl, President of Sonora

Q.: Do you think it is safe to sell large consoles without FM band?

A.: No. It is unsafe except possibly with low-priced consoles. As FM becomes more and more available, your customers will want to trade in their AM consoles for sets with both AM and FM. Thus you will have trouble with trade-ins and returned merchandise, particularly with your credit customers.

*Joe Gerl*

# Sonora

Clear as a Bell

HOME ENTERTAINMENT AT ITS BEST

RADIOS . . . F M . . . TELEVISION SETS . . . RECORDS . . . PHONOGRAPHS . . . RECORDERS

Check These Exclusive

# KWIKHEAT

# SOLDERING

# IRON

Advantages!



- ★ SAVES TIPS
- ★ SAVES TIME
- ★ SAVES EFFORT
- ★ SAVES WEIGHT
- ★ SAVES CURRENT
- ★ SAVES THE IRON

**HOT IN 90 SECONDS  
READY FOR USE . . . !**

Its many exclusive features put the Kwikheat Soldering Iron in a class by itself. That's why it wins enthusiastic praise from those who use it—why Kwikheat is fast becoming America's most talked-about iron—why you certainly want to stock it . . . lists at \$11. Write today for complete information.

6 TIP STYLES  
Interchangeable



## Motorola Sales Position



Murray Yeomans, appointed Mid-West regional manager of the Galvin Mfg. Corp., according to W. H. Kelley, general sales manager. Mr. Yeomans' headquarters will be in St. Louis.

## New GE Appointments

Edgar A. Jett, II, has been appointed General Electric clock representative for the Cleveland area of the company's Great Lakes district, it has been announced by R. A. Buescher, district manager.

Don C. Ross has been appointed representative in Kansas City, Mo., for General Electric clocks, fans, heaters, sun-lamps, heat lamps and heating pads, it has been announced by H. A. Warren, central district manager of the company's appliance and merchandise department.

## New Postwar Models Shown by Hallicrafters

The Hallicrafters Co., Chicago, Ill., producers of high frequency radio equipment previewed approximately 20 new postwar radio receivers, and 17 new home models to be produced by the company's Ecophone division, at a showing in Chicago.

Home radio production calls for five or six table model radios and phono-radios, to be followed by the manufacture of console combination types, featuring AM, FM and short-wave.

## Spotlight on 1946

(Continued from page 37)

and face a bright future if the current interest in frozen foods is any indication. Widespread publicity on food freezers during the period when food shortages were most acute, has resulted in widespread knowledge of them on the part of the buying public.

Home laundry equipment is ea-

gerly sought after by the consumer, and it is extremely doubtful if dealers will experience any difficulty in selling all the washers and ironers they can get their hands on in 1946.

There appears to exist at this time a market for about five and a half-million washers. At this writing the selling hasn't even commenced, and it does not seem possible that even the slightest dent will be made until at least the second quarter of the coming year.

Automatic or sequence washers will add that something new touch to sales in 1946 since many of the large manufacturers are out to get their share—or more—of this market. A few large makers plan bringing out low-priced automatics, but most of the makes will be considerably more expensive than the conventional wringer or spinner types offered for sale. De luxe wringer and spinner washers will sell well at comparatively high prices. As a matter of fact, the public will, at this time, buy anything the retailer has in laundry equipment, and will do so for some time to come.

Expected to increase rapidly in sales are electric ranges, dishwashers and garbage disposal devices. New homes, planned along efficient and modern lines, will boost sales of the before-mentioned appliances because many such homes will have adequate electric service and "complete" kitchens.

Air-conditioning of some sort will be a must for the modern-minded householder in 1946, and the public's awareness to the importance of temperature and humidity control will result in greatly increased sales of complete air-conditioning equipment, attic ventilating fans, room coolers, automatic heating equipment, etc.

Small appliances in great variety will soon be on the market, and dealers are planning to devote more attention to them than ever before. Some new makers are in the field and all of the old-timers will be back with improved equipment.

Vacuum cleaner manufacturers are producing tank, brush-driven and "straight-air" hand cleaners, and in this field it is worthy of note that some radically new sorts of equipment have been brought out.

All in all, 1946 promises great things for the nation's retailers, wholesalers, manufacturers and consumers.

Dealers will be glad of this great new opportunity to sell things.



No. E-514, Table Model, AC or DC

Portrait of one of the new Temple Radios\* that will soon be making new sales records.

*\*The complete Temple line will range from handsome table sets to magnificent radio-phonograph consoles.*

**TEMPLE TONE RADIO MFG. CORP.**

NEW LONDON, CONN.

Executive Offices — 220 East 42nd St., New York, N. Y.

**"WHERE FM ALSO MEANS FINEST MADE"**



# PHONOLAS are being shipped NOW through these Exclusive distributors!

## EASTERN AND EXPORT TERRITORY

Sales Office, New York, N. Y.  
Export Agents—American Steel Export Company, New York 17, N. Y.

**Connecticut**  
Roskin Distributors, Inc.,  
Hartford 5, Connecticut

**Delaware**  
Motor Parts Company,  
Philadelphia 22, Pennsylvania  
Jos. M. Zamoiski Company,  
Baltimore, Maryland

**District of Columbia**  
Jos. M. Zamoiski Company,  
Baltimore, Maryland

**Florida**  
Cain and Bultman, Inc.,  
Jacksonville 1, Florida  
Watts-Newsome Company, Inc.,  
Birmingham 3, Alabama

**Georgia**  
The Yancey Company, Inc.,  
Atlanta, Georgia

**Maine**  
Farrar-Brown Company,  
Portland, Maine

**Maryland**  
Jos. M. Zamoiski Company,  
Baltimore, Maryland

**Massachusetts**  
Columbia Wholesalers, Inc. of New England,  
Boston, Massachusetts  
Roskin Distributors, Inc.,  
Hartford 5, Connecticut  
Simons Distributing Company,  
Providence, R. I.

**New Hampshire**  
Columbia Wholesalers, Inc. of New England,  
Boston, Massachusetts  
Farrar-Brown Company,  
Portland, Maine

**New Jersey**  
E. B. Latham and Company,  
New York, New York  
Motor Parts Company,  
Philadelphia 22, Pennsylvania

**New York**  
Onondaga Supply Company,  
Syracuse, New York  
Roskin Brothers, Inc.,  
Albany 5, New York  
Times Appliance Company,  
New York 10, New York  
Western Merchandise Distributors, Inc.,  
Buffalo 2, New York

**North Carolina**  
Southern Bearings and Parts Company,  
Charlotte, North Carolina

**Pennsylvania**  
Ludwig Hommel and Company,  
Pittsburgh, Pennsylvania  
Motor Parts Company,  
Philadelphia 22, Pennsylvania  
Roskin Brothers, Inc.,  
Albany 5, New York  
Western Merchandise Distributors, Inc.,  
Buffalo 2, New York

**Rhode Island**  
Simons Distributing Company,  
Providence, R. I.

**South Carolina**  
Southern Bearings and Parts Company,  
Charlotte, North Carolina

**Tennessee**  
Southern Bearings and Parts Company,  
Charlotte, North Carolina  
The Yancey Company, Inc.,  
Atlanta, Georgia

**Vermont**  
Roskin Brothers, Inc.,  
Albany 5, New York

**Virginia**  
Charleston Electrical Supply Company,  
Charleston, West Virginia  
Jos. M. Zamoiski Company,  
Baltimore, Maryland

**West Virginia**  
Charleston Electrical Supply Company,  
Charleston, West Virginia  
Ludwig Hommel and Company,  
Pittsburgh, Pennsylvania  
Jos. M. Zamoiski Company,  
Baltimore, Maryland

## MIDWESTERN AND WESTERN TERRITORY

Sales Office, Chicago 4, Illinois

**Alabama**  
Watts-Newsome Company, Inc.,  
Birmingham 3, Alabama

**Arizona**  
Albert Mathias and Company,  
El Paso, Texas  
Albert Mathias and Company,  
Phoenix, Arizona

**Arkansas**  
Woodson and Bozeman, Inc.,  
Memphis, Tennessee

**California**  
H. R. Basford Company,  
San Francisco, California  
Ray Thomas Company,  
Los Angeles, California

**Colorado**  
The B. K. Sweeney Electrical Company,  
Denver 17, Colorado

**Idaho**  
Flint Distributing Company, Inc.,  
Salt Lake City, Utah  
Sunset Electric Company,  
Seattle 14, Washington

**Illinois**  
The Artophone Corporation,  
Saint Louis, Missouri  
The Sampson Company,  
Chicago 16, Illinois

**Mississippi**  
Walther Brothers Company,  
New Orleans, Louisiana  
Woodson and Bozeman, Inc.,  
Memphis, Tennessee

**Missouri**  
The Artophone Corporation,  
Saint Louis, Missouri  
Federal Distributing Company,  
Kansas City 8, Missouri

**Montana**  
Sunset Electric Company,  
Seattle 14, Washington

**Nebraska**  
Omaha Appliance Company,  
Omaha, Nebraska  
The B. K. Sweeney Electrical Company,  
Denver 17, Colorado

**Nevada**  
H. R. Basford Company,  
San Francisco, California  
Flint Distributing Company, Inc.,  
Salt Lake City, Utah

**New Mexico**  
Albert Mathias and Company,  
El Paso, Texas

The B. K. Sweeney Electrical Company,  
Denver 17, Colorado

**North Dakota**  
The Roycraft Company,  
Minneapolis, Minnesota

**Ohio**  
Bennett Radio Co., Inc.,  
Columbus 15, Ohio  
Charleston Electrical Supply Company,  
Charleston, West Virginia  
Ludwig Hommel and Company,  
Pittsburgh, Pennsylvania  
Modern Distributing Company,  
Cincinnati 10, Ohio  
Philco Distributors, Inc.,  
Detroit, Michigan  
Strong, Carlisle & Hammond Company,  
Cleveland 13, Ohio

**Oklahoma**  
Miller-Jackson Company, Inc.,  
Oklahoma City, Oklahoma

**Oregon**  
Sunset Electric Company,  
Portland, Oregon

**South Dakota**  
Omaha Appliance Company,  
Omaha, Nebraska  
The Roycraft Company,  
Minneapolis, Minnesota

**Tennessee**  
Woodson and Bozeman, Inc.,  
Memphis, Tennessee

**Texas**  
Crumpacker-Covington Company,  
Houston 2, Texas  
Albert Mathias and Company,  
El Paso, Texas  
Miller-Jackson Company, Inc.,  
Oklahoma City, Oklahoma  
Southern Equipment Company,  
San Antonio, Texas  
The Southwestern Company, Inc.,  
Dallas 1, Texas

**Utah**  
Flint Distributing Company,  
Salt Lake City, Utah

**Washington**  
Sunset Electric Company,  
Portland, Oregon  
Sunset Electric Company,  
Seattle 14, Washington

**Wisconsin**  
Radio Specialty Company,  
Milwaukee 2, Wisconsin  
The Roycraft Company,  
Minneapolis, Minnesota

**Wyoming**  
Flint Distributing Company,  
Salt Lake City, Utah  
The B. K. Sweeney Electrical Company,  
Denver 17, Colorado

We are shipping  
**PHONOLAS**  
NOW!  
The new improved acoustic  
models are on their way now in quantities  
limited only by the  
available supply of materials.

... And as more  
materials are released, more  
Phonolas ... acoustic  
and electronic ... will be  
directed to you and your  
customers.

**Phonola**  
ACOUSTIC AND ELECTRONIC  
PHONOGRAPHS

**WATERS CONLEY  
COMPANY**  
ROCHESTER, MINNESOTA

NOTE TO CANADIAN DEALERS  
In Canada, Waters Conley phono-  
graphs are sold under our  
"Melodier" trade name



Eastern and Export Sales Office  
17 E. 42nd Street, New York City, VA. 6-2079  
Midwestern and Western Sales Office  
224 S. Michigan Ave., Chicago, HAR. 1880





*Better Reception  
from Every  
Point of View*

**There's Popular Appeal in  
HOWARD *Radios* - Steady Profits Too!**

Every day finds more and more dealers signing for the Howard Radio Franchise—for a line that promises steady sales and profitable business.

And every day, Howard consumer advertising in big mass circulation magazines keeps on selling the merits of Howard Radios to hundreds of "I-want-a-new-radio" prospects right in your own trading area.

If you want a complete radio line that will make you real money, write us for the name of the nearest Howard Distributor.

**HOWARD RADIO COMPANY**  
CHICAGO 13, ILLINOIS



**HOWARD**

*... a Symbol of Craftsmanship  
since the beginning of radio*

*America's Oldest Radio Manufacturer*

# JOBBER ACTIVITIES

## **Personnel Changes in Florida Jobber's Sales Staff**

Troy A. Brown, president and general manager, Raybro Electric Supplies, Inc., Tampa, Jacksonville, Miami and St. Petersburg, announces changes in key positions:

W. R. Young, who has managed the Miami branch for the past seven years, will move to Tampa to become sales manager of supply and utility sales. C. V. Brown, who has been connected with Raybro in a sales capacity and other positions for the past fifteen years, moves to Miami to become Miami's branch manager. A change in the management of the Jacksonville branch is also announced, with Fred Elwes succeeding R. L. Rhodes. John Braun, has assumed duty as manager of the St. Petersburg branch, succeeding Mr. J. H. Wade, who has been transferred to the merchandise department in Tampa.

## **Scott Appoints More Than Hundred Jobbers**

Scott Radio Laboratories, Inc., Chicago, in naming new franchised dealers, illustrated their change in distribution methods. Scott has selected more than one hundred retail establishments, in key centers of the country that will merchandise and service its sets.

Among those franchised are: May's Music Co. of Albuquerque, N. M.; Grinnell Brothers, Battle Creek, Mich.; Len Walter's Music Store, Butte, Mont.; Chester E. Wells Co., Casper, Wyo.; Woodrum's Home Outfitting Co., Charleston, W. Va.; Andrew's Music Co., Charlotte, N. C.; Fowler Brothers Furniture Co., Chattanooga, Tenn.; Chester Wells Music Co., Cheyenne, Wyo.; Heim's, Danbury, Conn.; and Brander's Music Shop, Duluth, Minn.

## **Adds New Lines**

Westchester Electronic Supply Co., White Plains, N. Y., has been appointed distributor for RCA, IRC and Cornell-Dubilier. Hans A. Soms owner of WESC is now expanding his business into the field of sound equipment and amateur receivers and parts. Bill Ziner, W2MMY, is in charge of the amateur department.

## **Sceli Sells Trade Name**

R. G. Sceli & Co., Hartford, Conn. distributors, has sold its former trade name of Radio Inspection Service Co. to J. L. Ottenberg & Associates. The latter company will conduct a radio sales and service organization under its new name at 227 Asylum St., which is the Sceli Co.'s former address.

## **Electronic Labs Names Product Distributors**

Electronic Laboratories, Inc., Indianapolis, Ind., named B. G. Twyman and Associates, Chicago industrial consultants, as their distributors for the states of Illinois and eastern Missouri, outside of the metropolitan districts of Chicago and St. Louis. They will represent the Laboratories on all their products.

Walter E. Peek, Electronic Laboratories, sales manager, also announced that the territory of A. E. Rodman, West Coast representative, has been increased to include Nevada and Oregon.

## **National Union Jobber**



Harold Olsen, left, National Union distributor in San Antonio, Tex., takes time out to relax with Jack Clune, N. U.'s sales manager.

## **Lasner Returns to Anchor**

S. I. Lasner, former sales manager of Anchor Distributing Co., St. Louis, Mo., will resume his duties at Anchor, following a brief vacation. He returned to this country from Europe, after two and a half years in the U. S. Army.

## **Recordio Wholesalers**

Wilcox-Gay Corp., Charlotte, Mich., announces that Wakem & Whipple, Inc., will again serve as the exclusive distributors of Recordio serving metropolitan Chicago and surrounding area.

Wakem & Whipple recently moved into completely new and modern quarters. The present building is a two-story structure with additional basement storage facilities.

## **Lear Set Distributors**

Lear home radios in the Utah and Idaho territory will be distributed by the Mountain States Distributing Co., Salt Lake City, Utah, according to Nate Hast, merchandise manager of the Lear home radio division.

## **Gibson Study Course to Aid Jobbers, Dealers**

Divisional sales managers of Gibson Refrigerator Co. have just completed a month's course of study at the home office, during which plans were made for increased sales cooperation with all Gibson distributors and dealers.

All sessions were headed by F. E. Basler, vice-president in charge of sales. Walter D. Krauter, national service manager, conducted a product school at the company's expanded service department at Belding. John L. Stephens, sales promotion manager, described forthcoming projects and Gregory V. Drumm, market development manager, explained the operation of a new and improved sales control plan.

## **Greusel Back With Firm**

Frank W. Greusel, president of the Greusel Distributing Corp., 808 N. Market St., Milwaukee, Wis., has returned to his own business, after being district manager of the WPB in Milwaukee since August 1942. The Greusel Distributing Corp. features specialties and electrical appliances for the home.

## **Eureka Appliances "Fly"**

Krich-Radisco, Inc., New Jersey wholesale distributors of radios and electrical appliances, received its initial delivery of Eureka home cleaning systems and cordless electric irons in a special air shipment.

## **Olson Gets Philco Line**

Olson Radio Warehouse, 73 E. Mill St., Akron, Ohio, has been appointed distributors by Philco for its line of auto radios, batteries, tubes and office inter-communication sets. Territory to be covered by Olson is unrestricted.

## **Rejoins Distributor**



Richard L. Connelly has returned from the Navy to his father's firm, F. B. Connelly Co., Seattle, Wash., as salesman.

# New!



# Porta-Power MODEL "H"

featuring . . .

## **HUM - FREE OPERATION**



Size 2 1/8" x 4 1/2" x 6 3/4"  
Shipping weight 5 pounds.

**Two section filter**, composed of three very high capacity condensers, and two oversized iron core chokes in the "A" supply:— and two high capacity condensers and an oversized choke in the "B" supply positively block out hum.

**Universal sockets** for battery plugs.

**Fits in 99%** of all portables.

**Circuit designed** for optimum voltage regulation and changes in line voltages.

**Weighs 4 1/2 Pounds** — and every ounce essential to topnotch performance.

**PROVIDES**

**"A"**

**"B"**

1.5v at 200 m.a.  
1.35v at 250 m.a.  
1.55v at 300 m.a.  
1.35v at 350 m.a.

90v at 13 m.a.  
101v at 8.5 m.a.

of 4, 5, or 6 tube, 1 1/2 volt battery Farm or portable radios from 105-125 volt, 50-60 cycle lines.

**O. P. A. APPROVED**

**PRICE MODEL "H" \$15.00**

*Jobbers — write for details . . . Dealers — See your Jobbers*

**GENERAL TRANSFORMER CORP . . .**  
1250 W. Van Buren St., Chicago 7, Ill.



**ALL SET  
FOR Delivery**

There's a great demand today for USALITE "A" and "B" Batteries and "A-B" Paks for portable radios. And USALITE is all set now to meet that demand with regular deliveries. Order from your jobber today.

USALITE Radio Batteries come in the same old familiar brown and yellow carton. But inside you'll find better quality and performance than ever . . . reflecting not only our many years in battery manufacture, but all the added "know-how" built up in the course of our war-time experience.

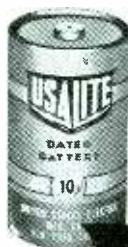

NO. 75  
HEAVY  
DUTY CELL  
FRESH  
DATE



**"A" & "B" Batteries for Portable Radios**

Made by the makers of famous  
USALITE Flashlights and Batteries

UNITED STATES ELECTRIC MFG. CORP. Factory and  
Exec. Off.: New York 11, N. Y. Branch Off.: Chicago 7, Ill.

### First Set to Governor

Oscar Dane, president of Templetone Radio Mfg. Corp., New London, Conn., presented Gov. Raymond E. Baldwin of Connecticut with the first Temple Radio off the assembly lines.

### Wyckoff President EMA

The Electronics Manufacturers Assn., Inc., a trade organization composed of leading manufacturers of radio sets and parts and electronic equipment in the New York metropolitan area, at its annual meeting, reelected I. Walter Wyckoff of Pilot Radio Corp., as its president. The following additional officers and members of the Board of Directors were also elected for the coming year:

Vice-presidents: Arthur Freed, Freed Radio Corp., and A. P. Hirsch, Micamold Radio Corp.; Secretary: I. A. Mitchell, United Transformer Corp.; Treasurer: S. J. Novik, Electronic Corp. of America. Members of the board of directors include the officers named and: Paul Hetenyi, Solar Mfg. Corp.; Nathan Kurman, Kurman Electric Co.; D. H. Engelson, Federal Mfg. & Engineering Co.; Charles Burnell, Clarostat Mfg. Co.; J. M. Marks, Fada Radio & Electric Co. Inc.; David Wald, United Scientific Laboratories Inc.; Max Weintraub, Garod Radio Corp.; Lloyd Hammarlund, Hammarlund Mfg. Co.; Meyer N. Leibowitz, Adams Laboratories Inc. Moses Shapiro has been retained as the association's general counsel.

### New Ansley Address

The Ansley Radio Corp. makers of Ansley Dynaphones and DynaTones, is now at its new location, 41 St. Joes Ave., Trenton, N. J.

### ECA Expands Facilities

Electronic Corp. of America has acquired an additional plant at 5302 Second Ave., Brooklyn, N. Y., in which to manufacture ECA radios and other products. The company will continue to operate its two Manhattan factories, according to Samuel J. Novick, president.

### White in Philco Post

Appointment of Lieut. Commander R. J. White, USNR, as assistant sales manager of the industrial radio division of Philco Corp. is announced by Leslie J. Woods, division manager.

### Monitor Lines Up Makers

The Monitor Equipment Corp., New York, newcomer to the home appliance field with plans for the eventual distribution of a complete line of home appliances to be offered retailers under one brand name, announces that 24 different manufacturing plants are now engaged in producing the Monitor line.

### Andrea General Manager



Frank V. Goodman, who has joined Andrea Radio Corp. as general sales and advertising mgr., according to President F. A. D. Andrea.

### Tone Products Marketing New Children's Phono

Irving Strauss, vice-president of Tone Products Corp. of America, New York, makers of musical merchandise for children, announces that the firm is ready to market its Merry-Go-Sound electrically amplified phonograph. Also made public is the company's entry into the juvenile recording field.

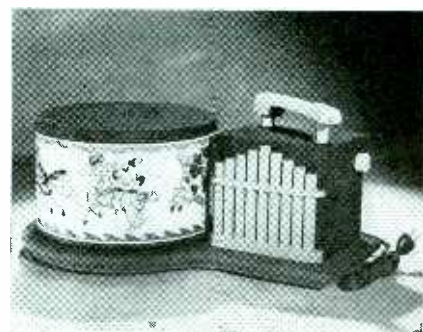

Tone Products Phonograph.

The organization at the present time is appointing distributors throughout the country. The new phonograph and a line of children's discs are expected to reach the market around the first of the year.

### Sylvania Offers Sales Aid

Sylvania Electric Products, Inc., Emporium, Pa., is offering dealers a circular for in-store or window display, stressing efficient service repairs done by the establishment. "Let Us Service Your Radio," "Expert Work at Reasonable Cost," and "We Use Sylvania Radio Tubes," are several of the points stressed.

### Changes at Hoffman

Paul F. Van Dusen, purchasing agent of the Hoffman Radio Corp., Los Angeles, has transferred to sales engineering. New addition to the same department is John Fill, formerly a civilian navy inspector.

# Confusion on **THEIR** part calls for clear thinking on **YOUR** part



Here is a scene typical of what the average American family is up against when it goes about picking a new radio television set. The old landmarks that used to guide its buying are outdated and in their place have come whole new arrays of names and claims.

Given such a situation, the value of any feature which will be immediately recognizable as a familiar symbol of quality becomes pretty important. And among such symbols, one is the use of genuine Mahogany for cabinets.

Yes, genuine Mahogany, the cabinet wood around which prosperous America plans its living rooms, can go a long way toward securing immediate acceptance for your new line of console, television, and combination sets. But that's not all it can do. It can also go a long way toward simplifying your future production problems, because, today, it is the only fine cabinet wood readily available in sufficient quantities to meet any foreseeable demand.

**MAHOGANY**



**ASSOCIATION, Inc.**

SUITE 2011A, 75 EAST WACKER DRIVE

CHICAGO 1, ILLINOIS

*"After All . . . there is nothing like MAHOGANY"*



Adjustable resistors in 25 to 200 watt ratings, 1 to 100,000 ohms. Fixed resistors in 10 and 20 watt ratings, 1 to 50,000 and 1 to 100,000 ohms, respectively.

★ And that means a lot! Those green-colored inorganic-cement-coated Clarostat power resistors are now found in radio-electronic assemblies that are built to last and last. These resistors positively "stay put". They are brutes for punishment. Remember Greenohms—for better initial equipment or for better maintenance work.

### ★ Order GREENOHMS!

Ask your jobber for Clarostat Greenohms. Try them—then draw your own conclusions. Ask also for other Clarostat resistors and controls. Ask for latest catalog—or write us direct.



CLAROSTAT MFG. CO., Inc. • 285-7 N. 6th St., Brooklyn, N. Y.

## Sales Set-Up Changes at American Central

C. Fred Hastings, general sales manager of the American Central Mfg. Corp., Connersville, Ind., announces a realignment of field sales representation. Regional sales managers in key cities are to report directly to a staff of sales specialists at the factory. Shifts in sales personnel include the following:

Harry Armbricht, eastern sales manager, moves to Connersville to head a newly-created contract kitchen equipment department. Succeeding him in New York as regional sales manager will be Leo J. Daugherty. Willis M. Marshall, formerly regional manager in Cleveland, moves to Kansas City and A. J. (Tony) McEwan, who has been district manager in New York, becomes a regional manager, with headquarters in Buffalo, N. Y.

Larry Coen, former midwestern sales manager, moves to Connersville as assistant sales manager of the kitchen equipment department, which is headed by Charles L. Stoup.

The Chicago office will be headed up by W. Graham Riley, J. W. Derr, at Atlanta, Ga., and John B. Taylor, at San Francisco, Calif., remain as regional sales managers. Three other American Central field sales representatives, James A. Craig, in Washington, D. C., Clyde T. Graham, in Dayton, Ohio, and Lon Evans, in Dallas, Tex., become regional managers in their respective territories.

## Sees Great Opportunity in Tele for War Vets

Speaking on opportunities in television for World War II veterans, Paul E. Carlson, director of merchandising for Allen B. Dumont Laboratories, stated: "Any television receiver, whether it

## President of NEDA



William Schoening, head of the National Electronic Distributors Assn., which is coordinating the activities of jobbers.

costs \$100 or \$1,500 must be properly installed by a man especially trained in this type of work—if we are to have a satisfied user.

"A very considerable force of men—and skilled men—will be required for this phase of television alone. It seems obvious that men with technical training in the armed forces will not only be fine candidates for this type of employment but that their ability to assure proper reception through technically correct installation can also make them much better sellers of teletests."

## Jobber Expands Quarters

Fort Orange Radio Distributing Co. has purchased two new buildings, concrete and fireproof, in which to better serve its dealers. This move added about 10,000 square feet of floor space to the firm's facilities, at Albany, N. Y.

## Radio Stars Rehearse for Cosmo Records



Harry W. Bank, left, Cosmo president, looks on as Joan Edwards, Hit Parade star, and Jerry Wayne, of the Borden's show, both exclusive Cosmo artists, try out a number.

*James J. Walker Announces . . .*

# The Alfred E. Smith Memorial Album

★

## *Majestic Album M-1*

- ★ MY GAL SAL
- ★ WHEN YOU WERE SWEET SIXTEEN
- ★ GIVE MY REGARDS TO BROADWAY
- ★ EASTER PARADE
- ★ I'LL TAKE YOU HOME AGAIN,  
KATHLEEN
- ★ THE BOWERY
- ★ HAS ANYBODY HERE SEEN KELLY?
- ★ THE BAND PLAYED ON
- ★ PUT ON YOUR OLD GREY BONNET
- ★ TAKE ME BACK TO NEW YORK TOWN
- ★ THE SIDEWALKS OF NEW YORK
- ★ TIM TOOLAN
- ★ Gounod's AVE MARIA

Here is a group of songs that Al Smith loved . . . songs that express the spirit of a romantic and carefree era of American life . . . songs that have long been America's favorites. The Alfred E. Smith Memorial Album comprises a collection of songs which might well be titled "Sing America!"

The songs in the album, and the cast that plays and sings them, were selected by a committee of close personal friends of Al Smith:

*Eddie Dowling, eminent actor and producer; Abel Green, editor of Variety;*

*Gene Buck, former president of ASCAP; and Eddie Cantor, beloved American comedian.*

*The star-spangled cast includes Danny O'Neil; Kay Armen; The Five DeMarco Sisters; Ray Bloch, His Orchestra and Chorus.*

Thousands of American families will want these favorite songs for their permanent record library. Get in touch with your Majestic distributor regarding this timely and profitable record album.

Majestic Album M-1, containing four 10-inch records, introduces a new note in record album design. A green simulated leather cover, stamped in gold, is protected by a distinctive dust jacket.

# *Majestic* RECORDS

Studio: New York City Sales: St. Charles, Ill.  
(Subsidiary of Majestic Radio & Television Corporation)

**MAKE  
IT  
MOVE**



**with  
ALLIANCE**

Thousands of Alliance "Even-Speed" phonomotors are now leaving the high speed production lines of Alliance every day.

We've done our best, during the war years, to keep all of our customers supplied despite the limited quantities military production permitted us to make. But now we're reconverting, stepping up production and quality beyond any previous peak . . . to give you the best, most dependable motor we've ever made!

So plan now to drive your turntables, recorders and combination record changers with Alliance Phonomotors!

**WHEN YOU DESIGN — KEEP**

**alliance**  
IN MIND

ALLIANCE MANUFACTURING CO.  
ALLIANCE, OHIO

### Maguire Appoints Karet

Robert M. Karet has been appointed manager of the electronic distributor and industrial sales department of Maguire Industries, Inc., Chicago, according to Oden F. Jester, general sales manager of the radio and electronic division of the firm. Under Mr. Karet's direction, all distributor and industrial sales of Maguire subsidiaries serving the electronic field will be coordinated.

### Manages GE Home Bureau

A. J. Brock has been appointed manager of the General Electric Co.'s home bureau, it has been announced by C. R. Pritchard, general sales manager of the appliance and merchandise department.

### Joins Wilcox-Gay

E. E. Chapman recently resigned as plant manager of the Lonergan Mfg. Co., Albion, Mich., to become assistant to the president of the Wilcox-Gay Corp., Charlotte, Mich.

### To National Radio Post

The National Radio Co. of Malden, Mass., has announced the appointment of William J. Larkin, of Lynnfield Center, as engineering manager of the company.

### Maryland Wholesaler Purchases New Building

Anticipating the huge pent-up demand for radios and appliances, the Associated Distributing Corp., headed by G. Lou Rifkin, exclusive distributors for Garod radios for Maryland and the District of Columbia, have purchased a new building to house their postwar radio and appliance lines.

Located at the corner of Charles and Lombard Streets, Baltimore, this building will give prominent outside display to Garod radios. Mr. Rifkin also announces that a sales branch of the company will be located in Washington, D. C., to service dealers in that area.

### Manager of N. J. Store

Charles G. Stouffer has been appointed manager of The Suburban Radio and Appliance Co., Orange, N. J. This new company has recently been organized for the sale of radio and television receiving sets and electrical household appliances and is one of New Jersey's largest retail establishments in this field.

### New Address for Jobber

The Packard Radio Co., Fort Smith, Ark., jobber, has announced that it plans to move to 205 Garrison Ave. A building at this location has already been leased by the company. The new address is in the heart of the wholesale and manufacturing districts of this city.

### Apex in Production



O. G. Frantz, right, president, Apex Electrical Mfg. Co., congratulates plant manager R. R. Todd for speedy reconversion job.

### Let the Customer Weigh What You Say

In making sales presentations, don't feed the customer more facts than he can absorb. The few easily understood features, cleverly presented, are what count. The only things you need to stress are the facts the customer *shows interest* in, and is able to understand.

*And*, you can never tell what simple remark you make, intentionally or unintentionally, is going to hit the customer like a ton of bricks.

One salesman we know "hog-tied" a large oil burner sale by declaring to a customer that "the 'Hades' is the 'Rolls-Royce' of the oil burner industry." No competitor could get this \$800 sale away from the salesman. No one knows whether pride of ownership, going the Joneses one better or desire to own a Rolls-Royce motivated the customer in paying this salesman \$200 more than the nearest competitor's price.

Another salesman, calling on a prospective customer who was in the market for a radio-phonograph, finding that he was getting nowhere fast in describing the operating features of the set, glanced about him, and said: "Mrs. Smith, the cabinet of this receiver was made to order for your living room. It will go perfectly with your Chipendale furniture." He got the order.

Such seemingly trite phrases as "this refrigerator's design permits *you* to put things where *you* want them", and "the ribbed sides of this washer make it more efficient", have caused many men and women to sign on the dotted line.

Salesmen are often amazed at how a prospect will clutch at some casual and apparently unimportant phrase.

Watching and studying the customer's reaction to what you tell him is all important in selling.

The facts that stick are the facts that count!



# The PROFESSIONAL Receiver

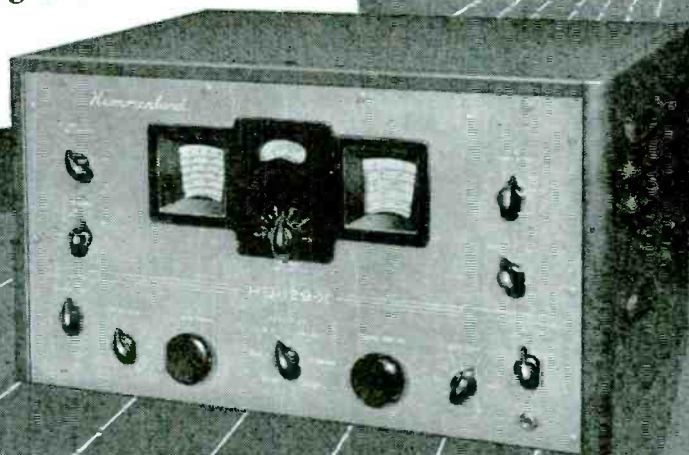

*New* **HQ-129-X** \$129 **AMATEUR NET  
LESS SPEAKER**

Price subject  
to change  
without notice.

WRITE TODAY FOR  
TECHNICAL BOOKLET

There is a difference. The HQ-129-X receiver is designed purely from a professional point of view. The treatment of every detail is based on professional requirements. As soon as your dealer has the HQ-129-X in stock, go in and look it over and try it—you will see, hear and feel the difference.



## HAMMARLUND

THE HAMMARLUND MFG. CO., INC., 460 W. 34<sup>TH</sup> ST., NEW YORK 1, N. Y.  
MANUFACTURERS OF PRECISION COMMUNICATIONS EQUIPMENT

# Everything FOR THE SERVICE DEALER

We have, ready for immediate delivery, a complete stock of tools, replacement parts, inter-communication systems, public address systems, test equipment . . . everything in radio equipment for the progressive service dealer. For big profit items . . . for quick delivery . . . place your order now with Leo.

## 6 TUBE AC-DC KIT

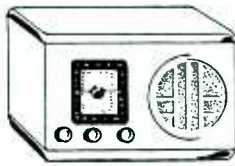

Complete, ready for assembly.

**\$23.75**

Cat. No. 7-691

A two-band, superheterodyne kit with all tubes, speaker, chassis, and all parts for easy assembly. Broadcast band from 540 to 1620 KC. Short wave from 5.7 to 18.3 MC. Cabinet, \$5.25.

## WRL MULTITESTER

All purpose tester. Money back guarantee.

**\$18.75**

less leads  
Cat. No. 16-439



Handles AC DC Voltmeter, DC Milliammeter, high and low range Ohmmeter. 3" meter with sturdy D'Aronsva movement. Size 5 1/2 x 8 x 3 3/4.

Exclusive at WRL!  
Our latest flyer . . .  
12 page V-J edition of merchandise and radio values. FREE.  
Handy Tube-Base Calculator . . . 25c  
Giant Radio Reference Map, 3 1/2 x 4 1/2 ft. . . 15c

### MAIL TODAY RT-12

Wholesale Radio Laboratory  
744 West Broadway Council Bluffs, Iowa

- Rush WRL Multitesters. Cost, \$ \_\_\_\_\_
- Send 6-tube AC DC Kits and cabinets. Cost, \$ \_\_\_\_\_
- I want a tube-calculator. 25c enclosed.
- Ship me your radio map. 15c enclosed.
- Send me your new V-J Flyer free
- Enclosed is \$ \_\_\_\_\_; Balance C.O.D.

Name \_\_\_\_\_

Address \_\_\_\_\_

Town \_\_\_\_\_ State \_\_\_\_\_

I am  an amateur;  experimenter;  service man



We invite industrial inquiries for electronic equipment and devices of all kinds.

**QUICK SERVICE FROM LEO**  
"same day" delivery service from the heart of the nation on anything in radio. Order today.

**Wholesale  
RADIO LABORATORIES**

## Jett Promises Low-Band FM Until New Service Is Adequate

In a letter received by the editor of RADIO & Television RETAILING, Commissioner E. K. Jett, the engineer member of the Federal Communications Commission, allays fears that low-band FM service is to be summarily cut off Jan. 1, 1946, as had been intimated by the FCC's orders to all FM licensees to have their new transmitters operating by that date. Delays in manufacture have held up such transmitters, and Commissioner Jett now advises: "At any rate I can assure you that we do not intend to close the present band until service is generally available in the new band".

Following is the letter from RADIO RETAILING's editor to Commissioner Jett, and the Commissioner's reply:

### EDITOR CALDWELL'S LETTER

November 8, 1945

Dear Commissioner Jett:

I am writing you as an FM listener who during the past 5 years has come to rely greatly on the FM channels for noiseless reproduction of fine music, at my home in the country near Greenwich, Conn.

But as 1946 approaches, I am considerably concerned at what may happen to us FM listeners if you shut down the present 40-50 mc FM band.

From what I have been able to find out, FM service on the new 100-mc band to which FM has been ordered, may be expected to be low in signal strength, limited in radius, and with few stations available in particular areas for some months or years to come.

Further, as I interpret your regulations, transmitter power of splendid stations which are now serving us listeners so adequately, will be cut to a few per cent of their former ratings. Rural service in the East will be pretty well wiped out.

Knowing that it is the Commission's responsibility to serve the public interest, convenience and necessity, I would respectfully urge that your body delay ordering the complete shut-down of the 40-mc channels for some months or possibly a year or two—until FM experience and development has fully progressed on the new channels.

Such a course would parallel the Commission's recent very wise action with respect to television,

wherein you authorized its continued operation on the present familiar television channels, while permitting experimentation in the higher frequencies.

Certainly FM should be granted the same opportunity. Such a course will permit FM to demonstrate its present matchless service to a larger public on its present familiar channels during the period the new 100-mc service is developing and being made satisfactory for public use. Unless the 40-mc band is thus continued for the time being, I foresee an immediate loss to us listeners of FM's fine service, and a delay in public appreciation and acceptance of FM's merits, for several years. This will in turn delay employment of thousands in the new FM industry which had been looked upon by most radio men as the No. 1 opportunity for radio industry reconversion.

No one understands better than I do the difficulties which confront your body, nor better appreciates the high standards of public service which animate your members and organization.

But committed as you are by law to serve the public interest, I see your only alternative to that end, as things now stand, to be in permitting 40-mc FM operation to continue during a transitory period of indefinite length, while the 100-mc band is being made ready for public use.

To deny such use of the 40-mc band for FM listeners during 1946, will be a distinct injury to the public interest, to millions of listeners, and to great rural areas—as well as a blow to employment of thousands in the promising new FM industry.

Respectfully,

O. H. CALDWELL,

EDITOR,

RADIO & Television RETAILING

### COMMISSIONER JETT'S REPLY

November 14, 1945

Dear Dr. Caldwell:

I wish to thank you for your letter recommending that the existing FM band, 44-50 mc., be continued until service is available on the higher frequencies. As you know the Commission has granted about 125 applications for new FM stations in addition to providing new assignments for existing licensees and permittees. Since there are about 500 more applications it is reasonable to assume that several hundred will be approved by the end of 1945. This should result in the construction of a large number of stations during 1946, which will enable the Commission to determine whether the existing frequencies should be continued or turned over to television. At any rate I can assure you that we do not intend to close the present band until service is generally available in the new band.

Sincerely yours,

E. K. JETT  
COMMISSIONER

FEDERAL COMMUNICATIONS COMMISSION  
Washington 25, D. C.

## Charlotte Jobber Takes on Radios, Appliances

C. A. Williams, Jr., president, and J. Lauer Williams, vice-president, of the Williams & Shelton Co., Inc., Charlotte, N. C., dry goods jobbers, announce their firm's entrance into the radio and electrical appliance field. Furman Ferguson, a pioneer radio and appliance man, has been appointed sales promotion manager to head this new operation. Williams & Shelton was organized in 1898.

An official said that it was the company's intention to enter the radio and appliance business early in 1941, but with the unsettled conditions and the possibilities of war, it was felt that it was not the time for his firm to expand and go into appliance selling. However, with the coming of peace, the firm contacted manufacturers, and lines were chosen. This firm is the distributor for Belmont Radio Corp.

The firm has issued a brochure entitled, "Streamline Distribution," which gives a story of the history and postwar plans of Williams & Shelton. As soon as conditions

permit, the company intends to erect a new building, on a site 226 ft. by 600 ft., located on a busy highway.

"Our representatives are already contacting the dealers in the two states (N. C., S. C.)," C. A. Williams explained, "and we are very happy over dealer acceptance of the lines that we distribute. Walker S. Gary, sales manager of this firm, states that with the adding of franchise lines the sales potentials of this firm in the two states has been greatly increased."

## HF FM Only City Service

Editor, RADIO & Television RETAILING:

Under the new regulations relegating FM to the 100-megacycle band, FM becomes then simply a city service, and the rural areas that need FM to eliminate static are deprived of this service.

Take, for instance, the State of Kentucky which has only one city of over 100,000, and while it has a population of 2,845,627, only 554,557 people live in the cities of 25,000 or over. This means that 80% of the population of Kentucky would be deprived of the advantages of FM.

H. C. BONFIG,  
Vice President

ZENITH RADIO CORPORATION,  
6001 Dickens Ave.,  
Chicago.



*but again*

# RAY-O-VAC RADIO BATTERIES

*proved their dependability!*

Returned fighting men remember how well RAY-O-VAC batteries served them in wartime radios. That's why they're demanding them for their peacetime sets. Get on the band wagon. Feature RAY-O-VAC —the dependable batteries that last longer.



OTHER FACTORIES AT CLINTON, MASS. • LANCASTER, OHIO • SIOUX CITY, IOWA • FOND DU LAC, WIS. • MILWAUKEE, WIS. • KANSAS CITY, MO.

**WHILE THEY LAST!**  
**SPECIALS**  
**"IN HARD TO GET"**  
**RADIO ITEMS**

**SPEAKERS...**

65"..... \$1.55  
 3 1/2"..... \$1.35  
 Each

**CONDENSERS**

.007-1600 V. Buffers.....	Assortment of 100 lots 10%	Each
.01-1600 V. Buffers.....		.14
20-150 V. Emerson.....		.18
20x20-150 V. Nat. Union		.30
10-450 V. Dumont.....		.45
RESISTORS—10%—	Extra Discount	.35
Any value		.05
1/2 Watt, Insulated....		.06
1 Watt, Insulated ....		

**SUPER VALUES**

GC Radio Trouble Lites.....	Each	.85
W.E. Crystal Pickup, Model AJ-1 .....		3.90
W.E. Crystal Cartridges, Model E-4 .....		2.35
Magnetic Cutter, 8 Ohm.....		4.95
Single Button Desk Stand		
Carbon Mike with push to talk switch, Army Sg. Corps Type T-32.....		5.95
Keys (\$2.00 Value).....		1.47
Bugs (Bunnel, Vibroplex, etc.) .....		5.95
A.C. Male Plugs.....per 100		3.50
Recording Discs (10" Metal) 10 to a Carton.....		.27

O-1 Ma. D.C. Meter (1000 Ohms per volt), 3 1/2" Round Bakelite Case, Choice 0-400 or 0-600 Scale	Each	
Reg. \$8.40 Net.....		5.95
Vacuum Tube Volt Meter.....		45.00
Radio City Volt-Ohm Meters.....		17.95
		6 up

**SOLDERING IRONS**

Ungar Pencil-Interchangeable tips.....	Net ea.	1.59
Standard (100 Watt, 3/8" tip).....		2.95
Drake (80 Watt, 3/8" tip, Model 225).....		2.10
Drake (125 Watt, 3/8" tip, Model 326).....		3.00
Drake (200 Watt, 3/8" tip, Model 425).....		4.95
Phono amplifier cabinets for 10" records, 5" speaker, 6 x 11 x 15 1/2".....		7.50
For 12" records, 6" speaker, 7 1/2 x 13 3/4 x 19", each .....		10.95

**Radio BELMONT Supply**  
 DEPT. L-2  
 Well. 5157  
 1921 W. Belmont Ave., Chicago 13, Ill.

**ECA Typatunes Come Off Assembly Line**



The first Typatunes come off the production line at the Electronic Corp. of America, New York. These musical instruments, which play music from a standard portable typewriter keyboard, will be available in time for Christmas sales. Standing behind line are, left to right, Jack Geartner, sales manager, and Samuel J. Novick, president.

**RCA Air-Expresses Sets**

RCA Victor shipped its first postwar table model automatic radio-phonograph combination to distributors by air express. The new sets from the company's Bloomington, Ind., plant, were rushed to RCA Victor distributors throughout the country to give them the earliest possible opportunity to display the model and accept orders on shipments to follow.

**Jefferson-Travis Takes Over Musicraft Corp.**

Jefferson-Travis Corp., manufacturers of radio communications equipment and continuous tape recording equipment, has concluded negotiations for the acquisition of all of the outstanding stock of the Musicraft Corp. and affiliated companies of New York City and Los Angeles, Cal., according to Irving M. Felt, president of Jefferson-Travis.

**Times Appliance Official**

Col. Arthur F. Callahan, upon leaving the Army, rejoined Times Appliance Co., New York City, Westinghouse distributors, as vice-president in charge of the appliance and radio division. He has broad business experience in the refrigeration and appliance business, and also in the construction field. He entered the Army early in 1942.

The Musicraft Corporation, which will be operated as a wholly owned subsidiary of the Jefferson-Travis firm, has a record pressing plant in Los Angeles and a plant presently being erected at Ossining, New York.

**Future Arvin Lines**

G. W. "Tommy" Thompson, vice-president in charge of sales, Noblitt-Sparks Industries, made known that distributor orders for more than a million Arvin radios are now on hand. The Arvin line will be complete with 20 models, beginning with a non-breakable cabinet, housing a 4-tube receiver, to a radio combination of three wave bands including FM. The manufacturer intends to back its distributing organization with a stepped-up schedule of national advertising on radios exclusively.

**Ward Dealer Display**

The Ward Products Corp., Cleveland, O., is featuring a new store display, stressing four of their new postwar lines of antennas. A striking gold eagle surmounts the brilliant orange board, outlined in blue. The display board is being shipped completely set up with four aerials already mounted.



"IT TAKES QUITE A BIT OF THE DRUDGERY OUT OF IRONING!"

We said it in 1935  
We repeat it in 1945

# Centralab RADIOHMS for all Replacements

There is no compromise with QUALITY . . . and Old Men Centralab has kept the faith through all the trying years. That is why the returning Radio Servicemen who "remember" as well as those who have newly entered the fold ask for and use CENTRALAB RADIO-OHMS on all Replacement jobs. Always specify CENTRALAB Radiohms.

### Producers of:

- Variable Resistors
- Selector Switches
- Ceramic Capacitors,
- Fixed and Variable
- Steatite Insulators
- and Silver Mica Button-type Capacitors.



**CALLING all  
Servicemen!**

# Centralab

Division of GLOBE-UNION INC., Milwaukee

**Attention GI JOE!**

Here's Your Opportunity to be First to

**Start Your Own RADIO SERVICE SHOP**

Complete Starting-in-Business Package Stocks of

**TEST EQUIPMENT TUBES, PARTS, TOOLS \$350 up**

Act quickly! Meet the pent up demand for radio service. Turn your special service training into a profitable business of your own. No fuss, No worry. Here's everything you need—\$350 up. Details upon request. Write, wire or phone



**TRIPLETT**  
Volt-Ohm-Milliammeter

**A. C.-D. C. Volts**  
0-10-50-250-1000-5000  
at 1000 ohms per volt.

**D. C. Milliampers**  
0-10-100-500

**Ohms** 0-300-250,000

**Case** Black molded  
3 1/4" x 5 3/8" x 2 1/8"

**\$16.00 net**

**Good News!** ALL PRIORITIES LIFTED

**HALLICRAFTERS SX-28A \$223**



SUPER DEFIANT	SX25	\$94.50
SKY CHAMPION	S20R	60.00
SKYRIDER MARINE	S22R	74.50
SKY RANGER	S39	110.00
ECHOPHONE	EC1A	29.50

ORDERS FILLED AS RECEIVED!!!

**MASCO AMPLIFIERS**



Complete with tubes.

17 Watt	30.30
25 Watt	42.60
35 Watt	54.60
50 Watt	70.50
17 Watt with Phono-top	42.30
25 Watt with Phono-top	52.20
35 Watt with Record-changer	89.10

**PHILCO BEAM OF LIGHT**  
Selenium Cell only, no holder .....1.80

20% deposit required on all C.O.D. orders. 2% transportation allowance on orders of \$25.00 or more accompanied by payment in full.

Write for FREE CATALOG

**RADIO SUPPLY & ENGINEERING CO., Inc.**  
128 SELDEN AVE. DETROIT 1, MICH.

**Southern Jobbers' Meet Held by Garod Corp.**

Garod Radio Corp., New York City, staged a southern conference in Atlanta, demonstrating its 1946 radio line for the benefit of nine regional distributors and several hundred dealers. Reid H. Cox, Garod's southern state's rep was impresario for the receiver showing and dealer meeting. Ray T. Ringler of Maga Distributors Ltd., Macon, Ga., welcomed the dealers and distributors. Lou Silver, Garod's sales manager, gave personal assurance to the dealers of protection and advertising support. Others greeting dealers were:

C. D. Stampley and Bill Stallings of Mill Distributors, Inc., Charlotte, N. C.; J. N. Houts and his associates of Clemons Bros. Co., Chattanooga, Tenn.; Dan Roberts of Electric Products Corp., Nashville, Tenn.; C. E. Howard and his associates from Monarch Sales Co., Birmingham, Ala.; J. D. Terrill and Mr. Daly representing McGowin-Lyons Co., Mobile, Ala.; Myron L. Alpert of National Radio Distributors, Miami, Fla.; George W. Bailey of Chapman Drug Co., Knoxville, Tenn.; R. P. Wilson of Wilson Distributing Co., Columbia, S. C.; J. D. Nowlin of Nowlin & Sons Co., Memphis, Tenn.

**New GE Blanket on Way**

The General Electric Co., Bridgeport, Conn., announces the development of a new two-control automatic electric blanket, scheduled to be available next spring. Incorporated into the blanket is the new single-strand, spiral-wound wire developed for use in flying suits. There are two individual temperature controls for the two-temperature blanket.

**Majestic Disc Plant**

Construction of a West coast plant for Majestic Records, Inc. was announced this week by James J. Walker, president of the record company. Located in Burbank, Cal., the new plant will be devoted exclusively to the pressing of Majestic Records. Equipment embodying the latest developments in the manufacture of records will be installed.

**Snyder Chicago Office**

Snyder Mfg. Co., Philadelphia, Pa., manufacturers of radio antennas and auto accessories, will open a Midwest sales office and showroom in the 333 Building, Chicago, about the first of the year, it is announced by Ben Snyder president. The new office will be headquarters for Snyder's Midwest representatives, Dwight Nelson, and Leo Gibrich.

**Presteline Jobbers Meet**

The Domestic Appliance Division of Pressed Steel Car Co., Inc., Chicago, is holding sales meetings with its distributors this month at which the first Presteline product, the electric range is being shown.

**Sales Help Available to Record Dealers**

To build sales of records at low cost, Frederick Kugel Co., 600 Madison Ave., New York 22, N. Y., is making available to dealers a booklet entitled "Record Review."

The booklet is offered to retailers on an exclusive territory basis, and each

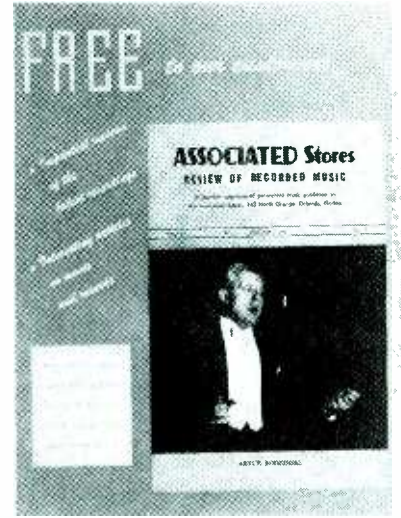

Colorful counter easel display of booklet service.

booklet bears the dealer's own cover design and name imprint. Facts of interest to disc buyers are in the pamphlet, which is issued monthly.

A limited number of cities are still open to dealers interested in using this form of advertising. Minimum order is 250 copies at \$7.50 for a six-month period.

**To Direct Crosley Sales**

Sydney D. Mahan has been appointed vice-president of the Crosley Corp., and general sales manager of its manufacturing division. He will be in charge of the firm's commercial activities.

**CBS Head Wins Honor**

William S. Paley, president of Columbia Broadcasting System, has been awarded the Legion of Merit for overseas service by Brigadier General Robert McClure, Chief of the Psychological Warfare Division under General Eisenhower's Supreme Command.

**Maguire Appoints Jester**

Maguire Industries, Inc., has named Oden F. Jester general sales manager of its radio and phonograph division, it is announced by Russell Maguire, president.

**Joins Los Angeles Staff**

J. J. Perlmuth and Associates, Los Angeles, announce the addition to its staff of Irving Finkel, formerly connected with the Newark Electric Co., N. Y. Mr. Finkel's work will be that of supplementing the sales and promotional activities of Jack J. Perlmuth and Paul F. Wiley.



Aerovox high-frequency capacitance bridge test of mica capacitors in heat chamber at right.

Block mica check for power factor. Every piece is checked before splitting and sorting according to thickness.

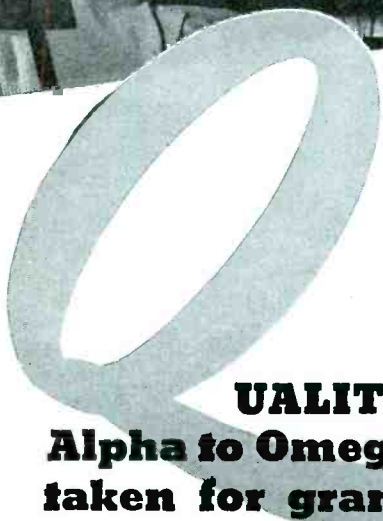

**QUALITY PRODUCTION CONTROL from Alpha to Omega... step by step... with nothing taken for granted or left to chance... spells AEROVOX MICA CAPACITOR**

*Craftsmanship*

● Mica capacitors are usually precision units. Capacitance tolerances may be tight. But even more important, critical characteristics such as power factor and "Q" must be met.

AEROVOX QUALITY CONTROL is exercised at every step in production. Incoming block mica is checked piece by piece for power factor and "Q." This proved invaluable

during the wartime mica shortage when new sources of supply had to be used. A spot check simply would not do.

Split micas are checked—electrically, visually, micrometrically. Mica assemblies are checked. Completed mica units are checked on the Q-meter. And since operating characteristics may change with operating temperatures, such units

are checked at given temperatures, by means of precision instruments of recognized accuracy, including Aerovox-designed and -built instruments.

It is this kind of production inspection, along with skilled craftsmanship and engineering "know-how," that accounts for the enviable reputation enjoyed by Aerovox mica capacitors.



*Capacitors*

**INDIVIDUALLY TESTED**

AEROVOX CORPORATION, NEW BEDFORD, MASS., U. S. A.

SALES OFFICES IN ALL PRINCIPAL CITIES

Export: 13 E. 40 ST., NEW YORK 16, N. Y. • Cable: 'ARLAB' • In Canada: AEROVOX CANADA LTD., HAMILTON, ONT.

DEPENDABLE MUTER PRODUCTS \* DEPENDABLE MUTER PRODUCTS

DEPENDABLE MUTER PRODUCTS

**Manufacturers of Component parts for the Radio, Electronic and Communications Industries . . . .**

**THE MUTER CO.**  
1255 South Michigan Avenue  
Chicago, U. S. A.

MUTER PRODUCTS \* DEPENDABLE MUTER PRODUCTS \* DEPENDABLE

### GE to Fair Trade Its Small Appliances

The General Electric Co. will fair trade its small electrical appliances at the retail price level, it has been announced by C. W. Theleen, manager of traffic appliance sales for the company's appliance and merchandise department.

Covered by the new policy are clocks, irons, mixers, toasters, roasters coffee makers, waffle irons, sandwich grills, portable heaters, heating pads and heat lamps, sun lamps, fans and automatic blankets.

### Mullins Executive Sees Big Kitchen Unit Future

Charles A. Morrow, vice-president in charge of sales for Mullins Mfg. Corp., Warren, Ohio, makers of Youngstown Kitchens, told more than 150 distributor representatives at a sales convention that, "We must help retail dealers everywhere to eliminate the profit-consuming selling methods that developed before the war."

The new Youngstown Kitchen line of steel equipment includes six twin-bowl cabinetsinks and three single-bowl models; twelve floor cabinet models, with continuous tops available for any combination of cabinets, fourteen wall cabinet models and an expanded accessory line.

### General Mills in N. Y.

James B. Moore, Jr., is sales manager of the metropolitan New York sales office of General Mills, Inc., Minneapolis, Minn. This is the company's first home appliance district sales office.

### Aireon Officials on RMA Committees

Jack Kaufman, vice-president of the Aireon Mfg. Corp. and in charge of that

### Operates Steam Shovel



Wm. J. Mailigan, Hallicrafters president, at controls, and Jos. J. Frenreis, secretary-treasurer, see work started on new factory.

corporation's San Francisco division, has been advised of his appointment to the transmitter tube committee of the RMA.

The RMA announcement also included the appointment of Dr. C. N. Kimball, vice-president of sales engineering at Aireon, to the emergency services committee and of W. T. Bishop, engineer in Aireon's railroad radio division, to the radio communication and marine aids, and aeronautical radio committees of RMA.

### "Bill Williams" Club

Bill Williams, editor of True, the Man's Magazine, has organized the "Bill Williams Club," a national organization of men by that name. A radio program, featured on WINS in New York, broadcasts the "Bill Williams Club of the Air."

### Landers, Frary & Clark New York Showroom



Shown is the attractive redecorated showroom and office of Landers, Frary & Clark, New Britain, Conn. This issue's electrical appliance cover was taken here through the courtesy of the firm.





**D**OWN through the years with Radio—right from the very beginning—STERLING has built specialized apparatus for the Radio market and at times—complete Radio sets for world-wide distribution . . . Millions of STERLING products,

battery eliminators, chargers, testers, have played a vital part in the development of Radio . . . Our wartime operations are now ended . . . Post-war products will reflect STERLING'S 39 years of successful electrical manufacturing experience.

**The Sterling Manufacturing Company** 9502 Detroit Avenue  
Cleveland, Ohio

**ELECTRICAL MANUFACTURERS FOR 39 YEARS**

**IT'S NEW! IT'S POST-WAR**  
**SUPREME Model 565**  
**VACUUM TUBE VOLTMETER**



NEW PROBE Streamlined  
 Hand Fitting Incorporating  
 new High Frequency Diode

**RANGES:**  
 DC 0-1, 2.5, 10, 50, 250, 500  
 AC 0-1, 2.5, 10, 50, 250  
 EXTENDED TO 5000 VOLTS BY EXTERNAL MULTIPLIERS

**FREQUENCY RANGE:**  
 Negligible frequency error from  
 50 cycles to 100 megacycles.

**INPUT RESISTANCE:**  
 DC—80 megohms on 1 volt range; 40 megohms on 500 volt range  
 AC—40 megohms on 1 volt range; 20 megohms on 250 volt range

**INPUT CAPACITY OF PROBE: 5 micro-micro farads**

**SUPREME INSTRUMENTS CORPORATION GREENWOOD MISSISSIPPI**

**ALWAYS GETS A HAND!**

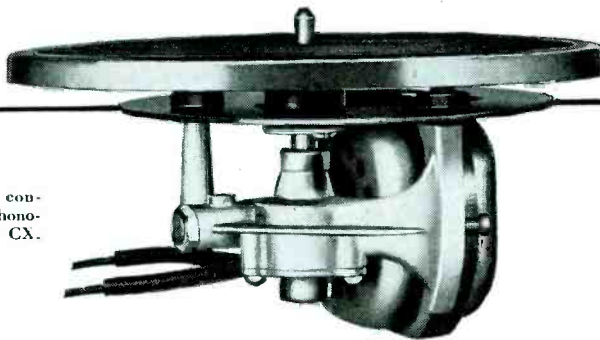

General Industries constant-speed electric phonograph motor—Model CX.

Users and the trade have always given hearty applause to General Industries phonograph mechanisms. Owners like the fine fidelity of every note or syllable—and sales and service departments are strong for their reliability and freedom from maintenance troubles.

You get this same old-time satisfaction from our *Smooth Power* turntable motors, recording assemblies and record-changer recorder com-

binations as we return to civilian production. As always, General Industries equipment will earn your approval.



**THE GENERAL INDUSTRIES COMPANY**  
**DEPT. M ELYRIA, O.**

**Bendix Appliances Plans Large Sales Program**

Bendix Home Appliances has set as its goal the sale of \$90,000,000 worth of its automatic washers, representatives of 125 parts suppliers were told by company executives at South Bend, Ind.

On the basis of independent surveys, the preference for Bendix automatic home laundries averages 30 per cent, the visitors were advised by Walter J. Daily, advertising director. He disclosed plans for a large scale advertising and product identification program.

Judson S. Sayre, president, estimated that 650,000 of the firm's washers will be sold in the next 14 months.

**Veteran Seeks Position**

Former Navy radio technician, 3rd class, wants position in New Jersey or vicinity. Age 37. Has 16 years complete radio experience, 8 months as radar technician, one year as maintenance man at Naval air station (transmitter, control tower, etc.) on VHF and MF equipment. Box B, Care of Editors, RADIO & Television RETAILING, 480 Lexington Ave., New York 17, N. Y.

**Gibson Appoints Johnson**

F. E. Basler, vice-president in charge of sales, Gibson Refrigerator Co., announces the appointment of J. Leonard Johnson as manager of Gibson brand sales for the company. The appointment, Mr. Basler stated, is to further strengthen the sales facilities and personnel of the firm.

"We have increased the number of Gibson sales districts from the eight which existed before the war to the present total of twelve," added Mr. Basler.

**With Fulwiler & Chapman**

Wm. H. Maxwell and David N. Long, formerly of the U. S. Navy, have returned to their positions with Fulwiler & Chapman, manufacturers representatives in Atlanta, Ga. Fulwiler & Chapman are sales reps in the southeast for Sylvania Electric Products Inc. radio tube division and Stromberg-Carlson Co. sound equipment.

**New Sentinel Plant**

With an estimated production of more than 3,000 radio sets per day, the new Sentinel Radio Corp. plant is now in course of construction. Occupying a 9-acre tract in western Evanston, the new plant will be housed in a single modern building of 125,000 square feet of floor space. In line with production expansion plans Sentinel president, E. Alschuler, has announced an extension of Sentinel national advertising.

**Visits Jensen Factory**

Rodolfo Rodriguez, owner and manager of Radio Industrial of Mexico City, Mexico, was a business visitor recently at the offices and factory of Jensen Radio Mfg. Co., Chicago.

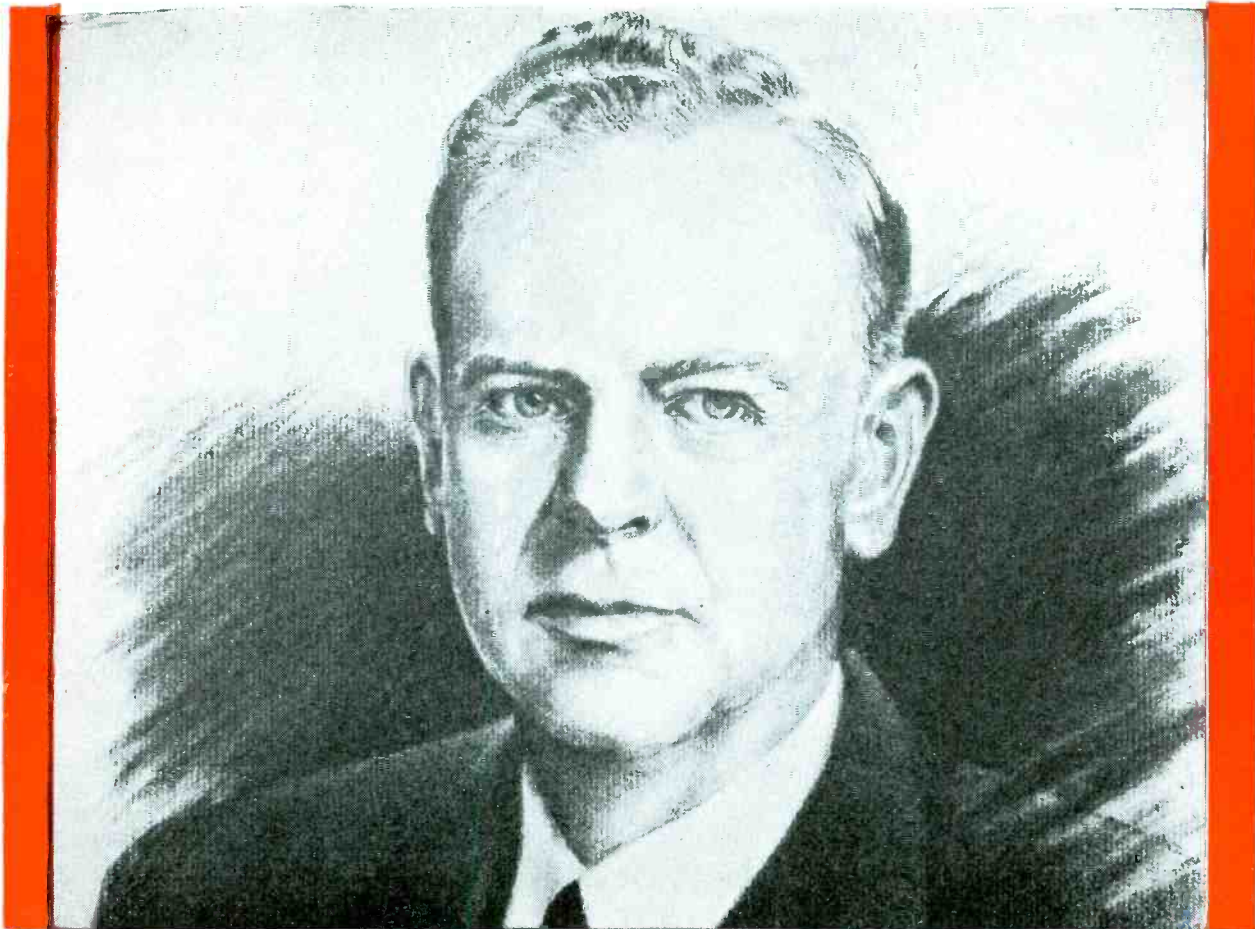

Portrait of Randolph C. Walker by John Carlton

# Engineers of Victory

## NOW SERVE MEN AT PEACE

The creative engineering which armed our fighting men for Victory has no less a responsibility in the years of peace ahead. Now that the war is won, we have the job of making this a better world.

AIREON produced huge quantities of communications and radar equipment and other machinery for waging war. Its achievements were equal to its heavy responsibilities, and its workers established an outstanding record of performance.

AIREON enters peacetime production with a notable engineering organization, highly skilled personnel and great confidence in the future. We have developed many products which will contribute to better living, for the manufacture of which all 15 AIREON plants will continue in production.

In order to extend our usefulness we recently established an experimental laboratory in Greenwich. AIREON's creative engineering in radio communications, electronics, musonics and hydraulics will team with production proficiency in contributing devices for future service.

In peace, as in war, AIREON will stand for quality and performance.

*Randolph C. Walker*  
PRESIDENT



# Cinaudagraph Speakers

A DIVISION OF Aireon

3911 SOUTH MICHIGAN AVENUE, CHICAGO

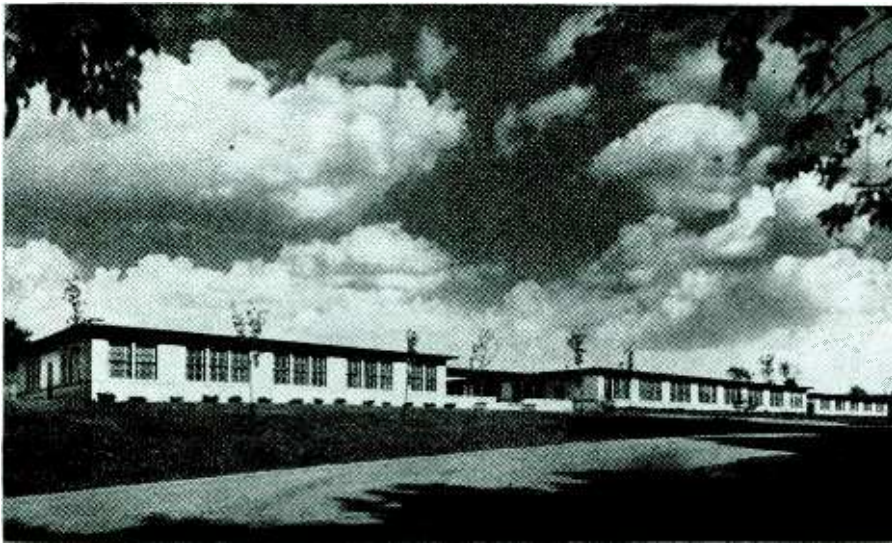

MANUFACTURERS OF RADIO, ELECTRICAL  
AND ELECTRONIC COMPONENTS

**VOKAR** Corporation

7300 HURON RIVER DRIVE • DEXTER, MICHIGAN

## NEW SOLDERING GUN

THE SPEED IRON\*



100 Watts 115 Volts 60 Cycles

*Soldering Heat in 5 Seconds*

Wherever you have a soldered joint in radio, electrical or electronic repair and service work, the Speed Iron will do the job faster and better.

The transformer principle gives high heat—in 5 seconds—after you press the trigger switch. Convenient to hold with a pistol grip handle, the compact dimensions of this new soldering tool permit you to get close to the

\*T.M. Reg. U. S. Pat. Off.

joint. The copper loop soldering tip permits working in tight spots. The heat is produced by the high current flowing through the soldering tip—permitting direct and fast transfer to the soldered connection.

If you want to save time on soldering jobs with a tool that is ready to use in 5 seconds get a Speed Iron today. See your radio part distributor or write direct.

**WELLER MFG. CO.**  
DEPT. RR-1 • EASTON, PA.

## 10 Ways to Take “Headaches” Out of Radio-Appliance Selling

1. Explain manufacturer guarantees to your customers.
2. Explain all “extras” involving additional costs *at the time of purchase*.
3. When filling out time contract forms get all the *credit information*. It's embarrassing to *you* and to the *customer* to follow-up for additional information.
4. Be sure to tell the customer how much the “finance” charge is. This will eliminate further discussion on this subject.
5. If you have to make a refund, make it cheerfully.
6. Know your product thoroughly. How much it costs to operate, etc. (See chart, page 62, Nov. 1945 issue. Learn to demonstrate effectively.
7. Remember prospective customers' names. *Our names* are our *most important possessions*.
8. Face complaint issues promptly. Procrastination and evasion on the dealer's part build up the case against him in the customer's mind.
9. Forget out-moded sales techniques. *Don't* ask for the order before you've explained the merits of the product. It is easier to get a “yes” when it has not been preceded by a “no”.
10. Customers appreciate your interest in them *after* they've bought. Be sure to follow up sales. Personal calls, letters or telephone may be used.

## “Biggest Radio Year in '46,” Says Joseph Gerl

A strong optimism on 1946 radio production was voiced by Joseph Gerl, president of Sonora Radio & Television Corp., at two luncheons for radio dealers in Portland, Ore., and Seattle, Wash. The meetings were held under the sponsorship of North Coast Electric Co., Sonora's distributor in that area.

“The slow start in producing civilian radios,” said Gerl, “has led some dealers to feel pessimistic about radio production in general. . . . I cannot tell you too strongly that the delay in reconversion was merely a temporary matter, that the wrangling by parts manufacturers and the OPA is likewise a temporary matter, and that radio production in 1946 will undoubtedly exceed any year's production in the history of the industry.”

## Specialize in Cabinets

The Cardwood Products Corp., 201-209 South Second Ave., Mt. Vernon, N. Y., intends to devote most of its factory space to the manufacture of portable phonograph cases and radio cabinets. The Jack Karns Co., New York City, is the firm's trade representative.

# E.L.

## AUTO RADIO VIBRATORS LAST 33% LONGER, RUN LIKE NEW "ALL THE WAY"!

E.L. Auto-Radio Vibrators give you and your customers, for the first time, the benefits of important advances in vibrators made by E.L. for vital war applications.

These precision-built, top quality synchronous and non-synchronous vibrators, developed and perfected by E.L. for the armed forces, are of the balanced resonance type with 8 contacts—twice as many as other makes in the non-synchronous types. These features, combined with a "quick-make, quick-break" action of the contacts, makes them last 33% longer and operate more efficiently and quietly. Their output-voltage and starting-voltage requirements are held virtually constant throughout the entire life-span.

**4** MODELS MEET 95%  
OF ALL AUTO-RADIO  
REPLACEMENT NEEDS!

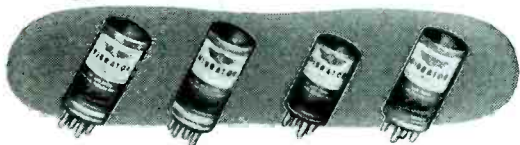

Only 4 models of E.L. Vibrators (models 1703, 2089, 2041 and 2088) to service the 1,122 auto-radio models which comprise 95% of the market. Smaller inventory, faster turnover, larger profits for both distributors and dealers! E.L.'s standardization plan is the most comprehensive ever offered in auto-radio vibrators! Order now from your distributor, and get the wall chart telling which E.L. Vibrator to use for most makes and models of auto-radios as far back as 1936.



**Auto Radio  
VIBRATORS**

*Electronic*

**LABORATORIES, INC.**  
INDIANAPOLIS

VIBRATORS AND VIBRATOR POWER EQUIPMENT FOR LIGHTING, COMMUNICATIONS, ELECTRIC AND ELECTRONIC APPLICATIONS

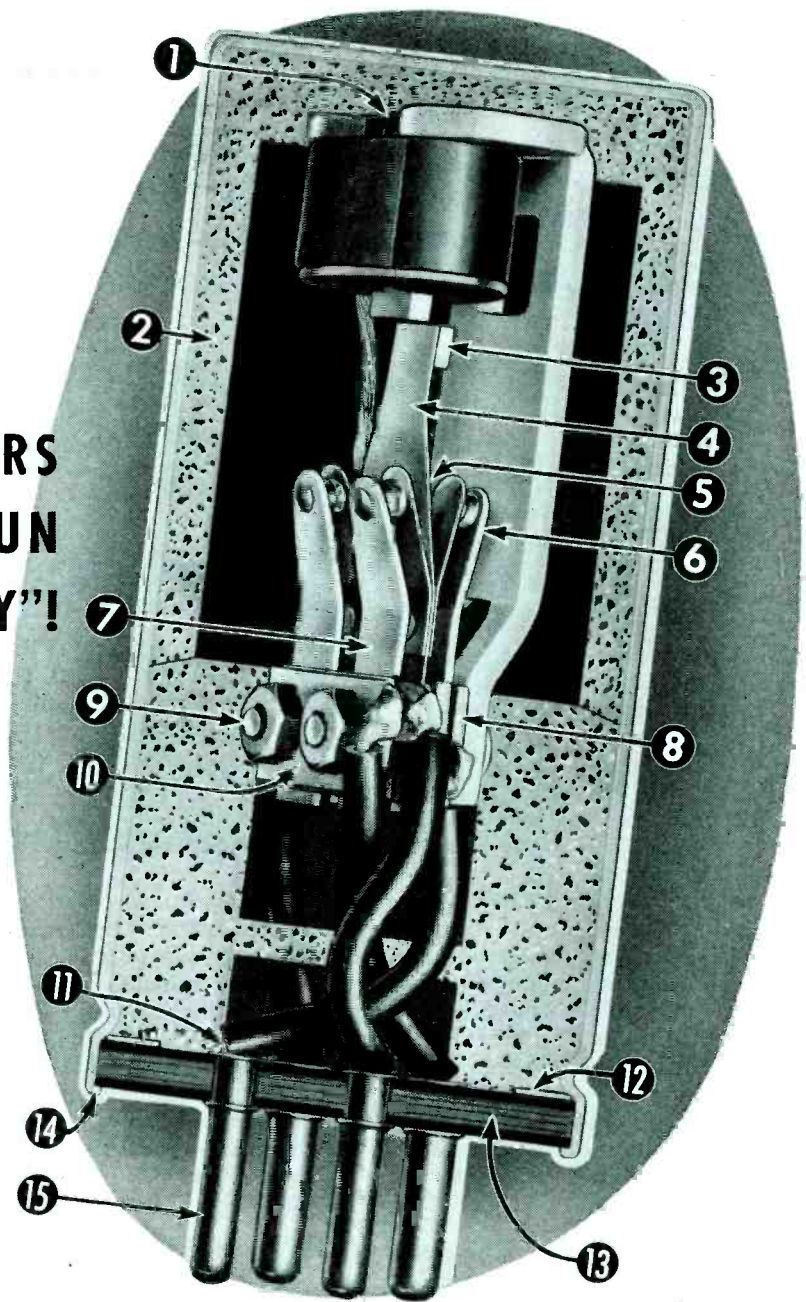

### E.L. AUTO-RADIO VIBRATORS BUILT FOR LONG SERVICE

1. Welded pole piece assures permanent accuracy of adjustment.
2. Synthetic sponge sound insulation molded to fit contour of vibrator.
3. Face of center reed weight is surface-ground to improve magnetic coupling.
4. Center reed uniformly stressed to prevent breakage.
5. Reed and side contact arms are specially tempered.
6. Side contact arms are silver-plated to prevent corrosion.
7. Spot-welding of fingers, in contact against each other and the center reed, reduces voltage drop in center-reed assembly.
8. Accurately ground bakelite spacers give structural accuracy and dimensional stability.
9. Double-screw stack helps maintain accurate adjustment.
10. Pressure plate on top of stack keeps stack tight under tension over wide ranges of temperature.
11. Extra-flexible roped wire used as leads to avoid any possibility of breakage.
12. Steel ring, molded into shock mount, centers and holds vibrator upright when can is sealed.
13. Neoprene wafer in hermetically sealed vibrators effectively seals vibrator against atmospheric pressure changes and moisture.
14. Metal can, spun at bottom, seals vibrator against dust and dirt.
15. Silver-plated pins assure minimum contact resistance.

COPYRIGHT 1945 ELECTRONIC LABORATORIES, INC.

**SELL PERFORMANCE  
SELL APPEARANCE  
SELL QUALITY  
SELL BELL SOUND EQUIPMENT**  
NATIONALLY KNOWN FOR ENGINEERING EXCELLENCE



**T**HE trim styling, ruggedly compact housing and feature-packed engineering of this 25-watt amplifier are typical of BELL Sound Systems for every need. Other highlights of Model 625 include electronic bass and treble boost, three separately controlled inputs, inverse feedback stabilizer, illuminated sloping panel, push-pull beam power output tubes and many other advantages. It hits the bulls-eye in sales appeal!

**Y**OU'LL want the latest information on the complete, up-to-the-minute line of BELL Sound Systems for every industrial and commercial need. In addition to the famous BELphone "intercom" systems, BELL offers a wide line of permanent and portable amplifiers, public address systems, recording and displaying equipment, industrial voice-paging and broadcasting equipment, and other electronic sound devices. Sell the name that sells itself . . . sell equipment that really meets the demand—Sell BELL! Write for details.



**BELL SOUND SYSTEMS, INC.**  
1186 ESSEX AVE. COLUMBUS 3, OHIO  
Export Office: 4900 Euclid Ave., Cleveland 3, Ohio

### "Reps" Buyers Guide

The Representatives of Radio Parts Manufacturers, Inc., through its industry relations committee, of which Robert E. Breuer is chairman, has announced that the 130 page Radio and Electronic Industry Buyers' Guide which they have issued is ready for distribution.

The directory is being distributed free to executives of radio manufacturers, distributors, laboratories, etc. Requests for copies may be directed to any member of "The Representatives," or to the National Secretary, David Sonkin, 347 Fifth Avenue, New York 16, N. Y.

### Clarostat Three-Day Sales Conference

Sales representatives from all sections of the country, met with the executive, sales, engineering and production staffs, of the Clarostat Mfg. Co., Inc., manufacturers of controls and resistors, at the company's three-day postwar sales conference in New York City.

The first day of the conference was spent visiting the two plants of the company. The second day was devoted to the industrial sales forum in the morning and the jobber sales forum in the afternoon, and a testimonial banquet in the evening. The third day of the conference was devoted to a general forum in the morning, followed by individual consultations in the afternoon.

### New Garod Radio Reps

Additions to the Garod's national sales organization have come with the appointment of territorial representatives in the middle west and south central sections of the country by Lou Silver, sales manager.

Lee Holland Co., 802 Waggoner Bldg., Ft. Worth, Tex., will serve Garod distributors in Oklahoma, Arkansas, Louisiana, and Texas. Leo Ungar and Co., 310 N. 11th Street, St. Louis, Mo., will act as sales representatives in Missouri, Kansas, Iowa, Nebraska, and southern Illinois.

### Directing Estate Sales



F. A. Deininger, after four years' absence, is again in charge of Heatrola products sales of Estate Stove Co., Hamilton, Ohio.

**Get EVERYTHING!**

Standardize on

**STANCOR** Transformers

Call your nearest Stancor Jobber...  
or write us for his address

**STANDARD TRANSFORMER CORPORATION**  
1500 N. HALSTED STREET • CHICAGO





She's  
**HIS CUSTOMER**  
 Before She's  
**YOUR CUSTOMER!**

Whose radio or appliance is this retailer demonstrating? Yours—or one of a hundred others? Before anything is bought, she will first be "sold" by the dealer promoting what he wants to sell—merchandise in which he has already invested.

Dealers invariably can change the minds of their prospects on brands in specialty selling, such as of appliances and radios. In nine sales out of ten they can switch their customers to what they want to sell. Prewar dealers averaged four lines of radios, one each of refrigerators and washers. Chances are consumers won't even get to see, let alone buy, your products unless the dealer displays them. And he won't, unless you sell him first through a campaign in the number one trade magazine: RADIO & Television RETAILING.

America's top radio-electrical dealers (24,000 out of 27,000 total circulation) choose RADIO & Television RETAILING each year as their most helpful trade magazine. That is why for twenty years it has been FIRST in paid circulation, FIRST in advertising, FIRST in his heart. Make HIS customer YOURS by telling and selling him through RADIO & Television RETAILING. That's the way to sell in this field!

**CALDWELL-CLEMENTS, INC.** 480 Lexington Ave., New York 17. PLaza 3-1340  
 Cleveland 14 • Chicago 6 • Los Angeles 14 • San Francisco 4



**KNOWN FAR AND WIDE**  
**AS THE LINE OF INTER-COMMUNICATION**  
**THAT "has everything"**

Talk-A-Phone has established a reputation for having developed and consistently produced the most highly perfected type of inter-communication . . . inter-communication that "Has Everything" . . . ultra modern design, superb beauty of finish, unsurpassed convenience, maximum efficiency, extreme flexibility.

This universally recognized leadership, built on top-ranking performance, opens



wide the door of a gigantic inter-communication market to Talk-A-Phone distributors all over America. See your jobber for complete details.

**Talk-A-Phone Mfg. Co.**  
**1512 So. Pulaski Rd. Chicago 23, Ill.**



The Green Vitrohm Enamel used in the manufacture of all Ward Leonard Vitrohm Resistors and Rheostats is an exclusive development of Ward Leonard Laboratories—the result of more than 50 years of intensive research in resistor enamels.

Pick the Resistor with the Green Vitrohm Enamel and you pick the best. Now available at your Radio and Electronic Parts distributor. Write for your free copy of our Radio and Electronic Resistor Catalog.

**WARD LEONARD ELECTRIC CO.**

Radio and Electronic Distributor Division  
 53 WEST JACKSON BOULEVARD, CHICAGO, ILLINOIS



**Navy Heroes Get GE Sets**



First new GE radios are presented to top officers of battleship Missouri. L. to r., Dr. W. R. G. Baker, GE vice-president; Capt. S. Murray, John L. Busey, pres. GE Supply Corp., and Comdr. Arthur Spring.

**Sylvania Survey Shows Large FM Set Market**

During the next two or three years, FM set production may add a new \$600,000,000 market to the radio set business, it is revealed by Frank Mansfield, director of sales research for Sylvania Electric Products Inc. "This means that 10,700,000 FM sets can be sold out of a total market for 17,400,000 sets," he said, in stressing the acceptance of FM by the public. He based his predictions on a special survey of radio set owners completed by the company to determine the immediate outlook for FM receivers.

He also said that FM set owners today represent less than 2% of all radio set owners and that three quarters of all FM sets in homes today were purchased in 1941 and 1942. The survey also shows that nine out of ten FM sets now in use are AM-FM combinations and 85% of their owners have other radios. Of these 73% cost between \$100 and \$399; 15% over \$400; and only 8% less than \$100.

Not only do people definitely want FM receivers but they are willing to pay more for them, according to Mr. Mansfield, who said that the survey showed that 56% of the prospects are willing to pay \$100 to \$150 more for an FM set with true high fidelity; 27% will pay \$30 to \$50 extra; and only 13% say they don't know how much more they are willing to spend.

**Thieves Steal Admiral Changer; Leave Some Cash**

Admiral Corp., Chicago, has just received word of the first theft of postwar Admiral appliances.

In Jersey City, N. J., according to Wallace C. Johnson, the corporation's field manager, burglars could not resist the appeal of an Admiral automatic record changer attachment displayed in the window of the Academy Radio Service store. Gaining entry through the rear door they went immediately to the front, picked up the record changer, stopped at the cash register and took only part of the money in it, then fled.





"ASK FOR  
SPRAGUE ATOMS  
BY NAME"

# SPRAGUE TRADING POST

A FREE Buy-Exchange-Sell Service for Radio Men



**FOR SALE**—Different assortment used radios and some tubes. Write for list. Glen Cruzan, Osgood, Ind.

**FOR SALE**—Following new tubes and adapter-tube combinations at list: 01A, 1R5/1A7, 1D5GP, 1S5/1H5, 1T4/1N5, 2B7, 6F5, 6H6, 6J5GT, 6K6GT, 6SK7GT, 6SQ7GT, 6X5GT, 7A7, 12AH7GT, 12J5GT, 12SA7GT, 12SK7GT, 12SQ7GT, 12SR7, 7A4/25Z5, 35L6, 35Z5, 50L6, 24A, 27, 42, 55, 80. Several of each in stock. Edward Howell, Rt. 2, Dillon, S. C.

**WANTED**—Old used radio equipment; eliminators; heavy-duty power transformers, etc. Have for sale tubes, repair parts, etc. Radio-Electric Labs, 715 N. 7th St., Lake City, Minn.

**WILL TRADE**—Radio parts such as variable condensers .000365, .000250 mfd. etc., and tubes such as 6K7, 6H6, 37, 1Q5GT, etc. Want 22 cal. revolver. Rea Bransard, 550-6 Rue Grand Mere, P. Quebec, Canada.

**FOR SALE**—New Hallicrafter receiver SX25 with 10" matching speaker, \$105. John Lim 449 Grant Ave., San Francisco 8, Calif.

**FOR SALE**—Hard-to-get tubes and parts. Send for list. E. J. Mangerl, 41-13 Tenth St., Long Island City 1, N. Y.

**WANTED**—Recorder, with or without playback. Will use Daco tube tester in deal. J. B. Vargo, 43 Norwood, Barberton, Ohio.

**FOR SALE**—25-50-100 watt resistors. all ohms; also power and filament transformers, chokes, power rheostats and 12SK7, 12SQ7, 117N7 and 25L6 tubes at list. Childs & Travis Radio Service 427 Main St., Darby, Pa.

**FOR SALE**—Radio City #308 tube tester \$20. John McGowan, White Pigeon, Mich.

**WANTED**—Signal generator and plug-in analyzer in good condition, Vince Electric Shop, 311 Elles Ave., Cartersville, Ill.

**FOR SALE**—Radio transmitter \$3.50; pocket portable radio, \$10; tubes 35Z5, 18A, 1A6, 71A, 80, 26, 27, 200A; 12A and 01A. Write for list and price: Radio Sales Co., 6202 Willard St., Shreveport 41, La.

**URGENTLY NEEDED**—Inverter 110v d-c from 110v a-c for servicing of d-c radios from 110v a-c power line (60 cycles). Cash or exchange tubes or test equipment. Frank Acosta, 50 E. 100th St., New York, N. Y.

**FOR SALE**—Any quantity critical tubes. 1A7, 50L6, 117Z6 etc. Murray Koch, 47 N. Main St., Paterson, N. J.

**FOR SALE**—RCA tube checker #156, \$30. Bernt Sundvold, Hudson, S. Dak.

**WILL TRADE**—Complete aircraft and engines mechanics course and additional data. Want radio test equipment, Riders Manuals, or what have you? A. G. Rowell, 3418 Old York Road, Philadelphia 40, Pa.

**FOR SALE**—Deco #303 tube tester, tests all tubes including ballast types; also a few hard to get tubes. Write for list. T. H. Clark, 1821 N. Caroline St., Baltimore 13, Md.

**SELL OR TRADE**—W-R-L or V-O-M multimeter almost new and Pilot short-wave adapter using 4 tubes 1-80, 1-27, 2-24, 10 to B. C. L. range. Want tube testers, or what have you? Jewell Radio Service, Box 24, Irving, N. Y.

**FOR SALE**—Assortment of radio parts in good condition, 40 parts and 26 tubes; 2 new unused 951's and 1-9001, 1. F. transformers, tuning condenser, chokes, transformers, connectors, dials, etc., \$10. Dave Duke, 12606 Arliss Drive, Lakewood 7, Ohio.

**FOR SALE**—I. E. S. Radio Service 40 book correspondence course, cost \$50, will sell for \$12.50. S. M. S. Radio Service, 2104 Royal Ave., Williamsport, Pa.

**WANTED**—10" and 12" record changer. Cash or will trade Univex 8mm movie camera with f3.5 lens and case. Pfc Donald Grib, 35234684, Co. 1, 326th GH. Inf., Ft. Bragg, N. C.

**FOR SALE**—Several Westinghouse capacitors, type FL, 6mfd. 1000 volts d-c. All have been tested at rated voltage. \$1 ea. Donald B. Morris, 303 Home St., Fairmount, W. Va.

**SELL OR TRADE**—Brewster 8-tube FM converter, like new. GI recorder-mixer record changer and Kodak Bantam special F-2, 1/500 sec. camera, slightly used. Want test equipment, short wave receivers, etc. A. M. Platt, 4102 Bowser, Dallas 4, Texas.

**WANTED**—Riders manuals. Must be in good condition. No abridged. State price in first letter. Wilbur Bray, Albany, Ohio. R. F. D. #2.

**FOR SALE**—Complete N. R. I. advanced course in radio communications. All text books and equipment are in A-1 condition. Never used. Paul Chinn, 92 N. High St., Columbus 15, Ohio.

**FOR SALE**—Instructograph code transmitter 5 to 40 w.p.m. with basic tapes, tube oscillator and key \$20. Samuel I. Goldish, 1500 South Frisco, Tulsa, Okla.

**WILL TRADE**—Have several new 955's. Will trade for 954's, 956's, 9001's, 9003's or what have you? John Isaacs, 2412 W. 156th St., Gardena, Calif.

**FOR SALE**—New tubes. 6 tube ac-dc radio kits, p.a. systems, phono pickups, mikes, etc. Want—70L7GT tube, signal generator. V-O-M. What have you and what do you need? Ben's Radio, North Tonawanda, N. Y.

**FOR SALE**—Tubes for receivers, parts, etc. If interested write O'Brien's Radio Service, 266 W. 4th St., Fulton, N. Y.

**URGENTLY NEEDED**—1A5, 1115 35Z5 and 117P7 tubes. Carl E. Chapman, 6018 E. Columbus Drive, Tampa 5, Fla.

**FOR SALE**—Meissner analyst, new, \$97; or will trade for set of Riders Manuals. Beverly Fairfax Appliance Co., 7016 Beverly Boulevard, Los Angeles 38, Calif.

**WANTED**—Complete set Scott all-wave plug-in coils (Standard Scott, 12-tube, 31 model) covering the short wave bands from 15 to 200 meters. Will pay reasonable price for set in good condition. Norman R. Bishop, 51 Hancock St., Portland, Me.

**FOR SALE**—New and used tubes (102), tube tester; multimeter model 446; Troubleshooters Manual; Mallory Encyclopedia and 3 Audels books. \$150 for lot or will trade for loud speaker system and \$35 in cash. H. E. Nabors, 50 Spring St., Arcadia, S. C.

**WANTED**—Stancor pack or other kind to operate auto sets for test bench use; vibrator tester, Triplett Radiart, Riders Manuals 6 to 14 singly or as lot. Will sell Simpson 333 tube tester, V-O-M. used dynamic speaker, etc. Royce Saxton's Radio Shop, Route 1, Pontiac, Ill.

**FOR SALE**—Hard to get tubes and parts. For list write Don Beckerleg, Wolf Point, Mont.

**WILL TRADE**—Thousand pieces assorted radio hardware and odd parts including dial knobs, pilot light sockets, input and output transformers, dynamic speakers, volume controls, switches, etc. Want tubes, crystal pickups, mikes, auto antennas, p.m. speakers, radio books, tools, test equipment, metal cabinets, fluorescent fixtures, indoor and outdoor neon radio signs. Troch, 341 Hummel Ave., Lemoyne, Pa.

**FOR SALE**—Weston 4 1/4" square type meter, zero to 50 microamperes with model 772 calibrated dial. Also Weston a-c rectifier and four precision wire wound resistors. All new. J. Holloway, Box 133, Haddonfield, N. J.

**FOR SALE**—Ghirardi Radio Servicing; Rider's Volume 14, also Radio City tube and multimeter #803 and tubes. Maurice McCann, 712 Romayne Ave., Itasca, Wis.

**WANTED**—Complete set or any portion of Rider's manuals. L. E. Cheney, 345 E. Lincoln Highway, DeKalb, Ill.

**FOR SALE**—Clarion 100-watt used amplifier with output meter, complete with tubes; Clarion 60-watt used amplifier complete with tubes and speakers in split carrying case. Homemade 40-watt amplifier complete with tubes, in perfect condition. Two trumpets with 25 watt driver units. Radio tubes 1A5GT, 1115GT, 1N5GT, 1P5GT, 3Q5GT, 6A7, 12SA7, 25Z5, 25Z6, 25L6, 35Z5, 35L6, 50L6, 117L7, etc. Standard Radio Service, 428 Main St., Hamilton, Ohio.

**SELL OR TRADE**—Metropolitan CA-10 signal tracer new, \$13; Solar CB1-60 condenser analyzer perfect, \$35; battery-operated signal generator, 7 bands R. F. output, 400 cycle audio output wireless Egert make, \$20 less batteries; also Remington typewriter #10A, \$25. All post-paid. Want portable recorder and playback; small ac-dc multimeter; 30 watt, 6v d-c. Nov a-c mobile sound amplifier with phono top. Ed. Pctzold, Electric Col. 1122 Milwaukee Ave., So. Milwaukee, Wis.

**FOR SALE**—Rider channelist complete with instruction book and leads. Almost new, \$107. Ted Hamilton, What Cheer, Iowa.

**WANTED**—Atwater Kent model 55, any condition. Will pay cash or trade late tubes. James A. Collins, 2632 Nashville St., Pittsburgh 4, Pa.

**FOR SALE**—One ea. a-c voltmeter #528; dual hi-low 0-120v, 0-15v Weston 528 a-c ammeter 0-10; 10 do-nut type hot water heaters (new) 110v, ac-dc. Want tube checker, signal generator or other test equipment. Alvin E. Schmidt, 723 N. Emily St., Ludington, Mich.

**WILL TRADE**—SW-3 receiver with coil coverage of 15 to 160 meters, less power supply. Want portable typewriter or cash. Make offer. Pfc. C. L. Rabung, 1508 Diversey Parkway, Chicago, Ill.

**WANTED**—All kinds of radio test equipment and all volume Rider manuals. Wm. E. Griner, R. R. #2, Pendleton, Ind.

**FOR SALE**—Western Electric 5" cathode ray tube (5B1P4-18U2P4), 13-tube circuit, weight 150 lbs. Only slightly used. \$100. Richard Salzer, 24 Berkeley Ave., Baldwin, N. Y.

Dept. RRT-125, SPRAGUE PRODUCTS CO., North Adams, Mass.

Jobbing distributing organization for products of the Sprague Electric Co.



# SPRAGUE CONDENSERS KOOLOHM RESISTORS

TM. REGISTERED U. S. PATENT OFFICE

Obviously, Sprague cannot assume any responsibility, or guarantee goods, services, etc., which might be exchanged through the above advertisements

## NBC Airs First Forum; Uses RCA Image Orthicon

Televising its first public forum and using for the second time the new super-sensitive image orthicon camera tube, NBC's television station WNBT N. Y., brought to viewers in the area the entire proceedings of the fourth and final session of the New York Herald-Tribune forum on current problems.

Appearing before the new television camera for the first time were Secretary of State James F. Byrnes, Secretary of War Robert P. Patterson, Secretary of Labor Lewis B. Schwellenbach, Lieut. Cord Meyers, Jr., Dr. Vannevar Bush, William H. (Bill) Mauldin and C. R. Smith.

The new RCA image orthicon which NBC used is able to transmit scenes il-

luminated by candle and matchlight and is so sensitive that it can pick up scenes with infra-red rays in a blacked-out room. This new electronic "eye" permits NBC's television department to schedule programs in daylight, moonlight, in good weather and in bad since many of the major difficulties of illumination are eliminated through the use of the tube.

## Columbia Names Schrader

Paul Southard, vice-president of Columbia Recording Corp., Bridgeport, Conn., announces the appointment of William Schrader as head of the order service department at Columbia's new plant located at Kings Hills, Ohio. Mr. Schrader will have charge of record distribution to all Columbia jobbers served by this plant.

## Lear Products Shine in So. California Show

The grand prize for the booth that was most attractive, that drew most traffic, and that was most unique in design and in the articles it presented to the public, went to Lear, Inc., for its presentation of the Lear home radio and wire recorder at the second annual Southern California Industrial Exposition. The booth included a display of Lear mechanical products for aircraft, as well as the Lear wire recorder, and models of Lear home radios.

Among the Lear officials attending the exposition were William P. Lear, president of the company; Nate Hast, merchandise manager of the Lear home radio division; and George Tharrat, who heads Lear's California division. The exhibition was manned by Fey & Krause, southern California distributor, who booked over \$500,000 worth of Lear home radio business. Bert Caygill, southern representative of Lear, was in charge of the exhibits.

## West Coast Retailers Shown New Olympics

At a luncheon meeting held under the sponsorship of V. J. McIntyre, of the Bandoli-McIntyre Co., Los Angeles, southern California distributors of Olympic Radios, one hundred and fifty leading home appliance dealers and department-store executives were introduced to the complete new line of Olympic Radios, consisting of consoles, table models, and portables.

The presentation of the line was made by John F. Crossin, Olympic's director of sales. The company's advertising and sales-promotion plans were explained by C. E. Staudinger, vice-president of Sherman K. Ellis Co., of New York.

## Sylvania Executives

E. Finley Carter and H. Ward Zimmer have been elected vice-presidents of Sylvania Electric Products, Inc., according to Walter E. Poor, president.

## Joins Rep's Staff



Fred Gross, appointed staff assistant to the J. Y. Schoonmaker Co., Southwestern manufacturers' representatives, Dallas, Tex.

**BROAD RANGE SELECTION  
IN A POCKET-SIZE INSTRUMENT**



**WESTON**  
MODEL 564—TYPE 3-C

**VOLT-OHMMETER**

An extremely compact WESTON quality instrument with a broad selection of resistance and DC voltage ranges. Ranges available from pin-jacks molded internally with the panel, a toggle-switch connecting meter in circuit as a Voltmeter or Ohmmeter. Readily adjusted for variations in battery potential. For full details on Model 564, and on WESTON Ohmmeters and Volt-Ohm-Milliammeters, send for literature. Weston Electrical Instrument Corporation, 581 Frelinghuysen Avenue, Newark 5, New Jersey.

**WESTON Instruments**

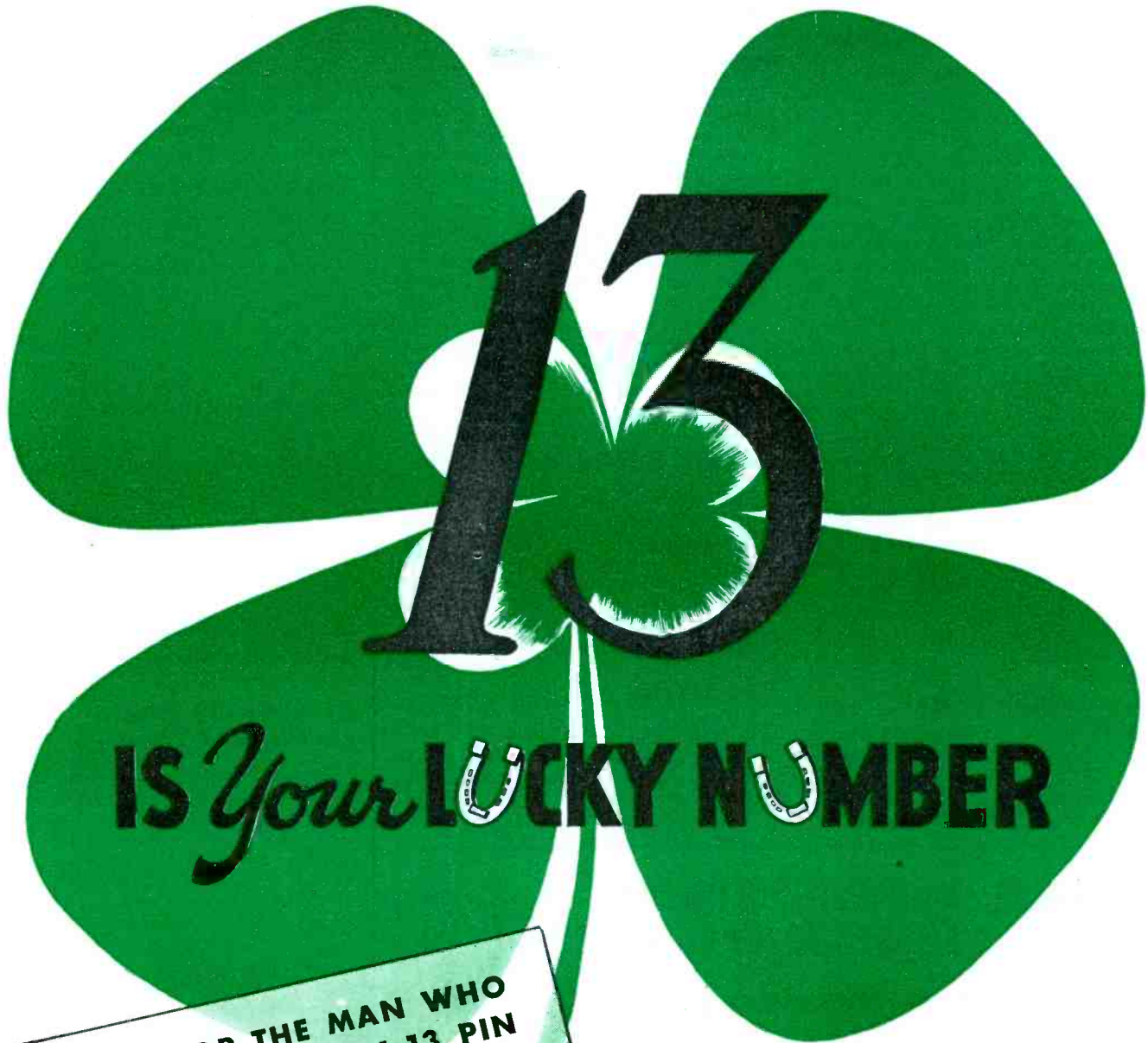

**LOOK FOR THE MAN WHO WEARS THE LUCKY 13 PIN**

His is a glowing future, guaranteed by the Lucky 13 Sales Plan. Next month's announcement of the completely new 1946 RECORDIO will unfold the Lucky 13 story. It's big news! Watch for it.

**DEALERS** *Mail this today!*



**Recordio**

by

**WILCOX-GAY CORPORATION • CHARLOTTE, MICH.**

*Manufacturers of*

**Recordio Discs**

*and*

**Recordioint**

**CUTTING AND PLAYBACK NEEDLES**

**WILCOX-GAY CORPORATION**  
Charlotte, Michigan

Gentlemen: Tell me more about the coming RECORDIO opportunity that is still open in my territory.

Store Name .....

Address .....

City .....

Zone .....

State .....

## Time-Saving Tip

Editor, RADIO & Television RETAILING:

It is my belief that the writing of this letter and a display of it in your valued magazine will be a service to the radio service industry.

Every radioman, at one time or another, is obliged when servicing a receiver to make use of service manuals such as Rider's, etc. Now, getting the necessary information, such as model number of the receiver, as well as the exact reference volume and page number, all take time, and sometimes more time than most of us would be willing to admit.

My simple suggestion is as follows: Having obtained the essential reference information, don't merely jot it down on a scrap of paper, but inscribe it on the chassis itself—prominently—where it is sure to be seen by yourself or other technicians who may be called upon to service the receiver.

This expedient will save much time—time which can be spent to better advantage in other useful pursuits.

BORIS S. NAIMARK

Rival Approved Radio  
780 Allerton Ave.  
New York, N. Y.

## First Temple Radio

Amid festive ceremonies, the Temple-tone Radio Mfg. Corp. started assembly lines rolling recently. Witnessed by hundreds of guests, the first set, No. E-14, ac-dc model, was made ready to ship.

## Hotpoint Dishwashers 30% Under 1942 Prices

Ray W. Turnbull, president of Edison General Electric (Hotpoint) Appliance Co., announced assembly line production of an automatic electric dishwasher that uses no soap, and does eight operations at one touch of a button. The fully automatic electric dishwasher was perfected in 1942, and priced at that time to sell at \$265. With the introduction of "assembly line" manufacture, the price will be dropped to \$198. The lowest cost model of the automatic machine will sell for \$184.50 while the model which includes a cabinet-sink will retail at \$249.50. All of these prices are approximately 30 per cent below 1942 costs, Mr. Turnbull declared in a recent statement.

## Proctor Sales Manager

Carl Birkhold has been appointed New Orleans district manager, by R. M. Oliver, vice-president, Proctor Electric Co., Philadelphia. In his capacity as district manager, Mr. Birkhold is responsible for the sale of Proctor appliances throughout Louisiana and Mississippi, and parts of Florida, Tennessee and Alabama.

## Case With Hallicrafters

Nelson P. Case, well known in the radio industry and holder of approximately 30 patents on radio receiver circuits, has joined the Hallicrafters Co., Chicago, as chief engineer of its receiver division.

## Maguire Buys Radiart

Purchase of the Radiart Corp., of Cleveland, a manufacturer of radio parts and accessories, by Maguire Industries, Inc., is announced by Russell Maguire, president of the latter company.

## Toastmaster Price Same

William E. O'Brien, general sales manager, Toastmaster Products division, McGraw Electric Co., announced that no increase in price is being planned on the new Toastmaster toaster. The pre-war list price of \$16.80, which includes Excise Tax, is still effective.

## New Auto Antennas

J. F. D. Mfg. Co., Brooklyn, N. Y., has completely reconverted to the manufacture of civilian radio replacement parts. High on its production list now are its auto radio antennas. Julius Finkel, president, announces the production of eight 3-section antenna types.

These telescoping antennas, according to Mr. Finkel, incorporate such features as stainless steel "snap back" top rod, shielded loom leads, etc.

## Phonola Ups Output Facilities at Plant

Phonola portable phonographs will be distributed nationally and exported to most parts of the world when production starts. Both acoustic spring driven and amplified models will be produced in the Waters Conley Co. plant at Rochester, Minn. The company's plant size has been almost doubled with extensive improvements in equipment and facilities. A modern engineering laboratory for mechanical and electronic development, a new design department, and re-engineered production methods will make possible many improvements in the appearance and performance of Phonolas as well as a 300% increase in volume of output. Phonolas are marketed in Canada under the trade name "Melodier".

## GE Sales Managers

The appointments of Clayton P. Dunning as manager of the newly-organized New York appliance sales district of the General Electric Co., and of Carleton A. Reeves as manager of the company's north-eastern appliance sales district, Boston, have been announced by C. R. Pritchard, general sales manager of GE's appliance & merchandise department.

## Gerber Sales Appointees

Harry Gerber, sales representative in the New England territory, and operating the Gerber Sales Co., Boston, Mass., announces that his son, Irving Gerber, a graduate of Worcester Polytechnic Institute, has joined the organization, and will handle industrial accounts exclusively. Ed Breen, who was at the Radiation Lab at M.I.T., has also joined the organization.

## JOBBERs, MANUFACTURERs — Send for latest catalog of KEYSTONE QUALITY PRODUCTS

Complete facilities and stock for the manufacture of special test leads and test equipment accessories; also terminal boards.

- TEST LEADS
- TEST PRODS
- PHONOTIP PLUGS
- ALIGNING TOOLS
- DIAL DRIVES
- TERMINAL BOARDS
- GLASS DIAL PLATES

KEYSTONE ELECTRONICS CO.  
50-52 FRANKLIN ST., NEW YORK 13, N. Y.

PILOT RADIO  
your beacon to a better business  
in better radios

### Mallory 4-Man Team to Aid Distributors

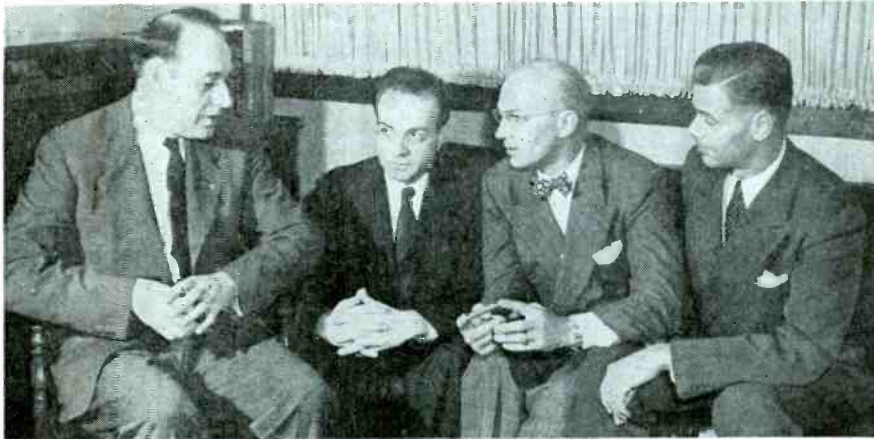

P. R. Mallory & Co., Inc., Indianapolis, Ind., has designated the four men shown as a liaison group between the company and its wholesalers. These officials will help jobbers plan product campaigns, catalogs, etc. L. to r., Byron Deadman, P. Newton Cook, Howard W. Sams (who heads the group), and Ralph B. Roberts.

### Premier Priority Kit

The Premier Division of the Electric Vacuum Cleaner Co., Inc., Cleveland, O., has made available a "priority kit" which its dealers will use upon receipt of sample cleaners. The kit includes priority certificates, mailing cards, advertising proofs, and literature on Premier's first model. The kit is packaged in a colorful broad-side.

### Meissner Names Manager

Appointment of Herbert G. Arcadius as district manager of radio phonograph sales, Meissner Mfg. Division, Maguire Industries, Inc., is announced by Oden F. Jester, general sales manager.

Mr. Arcadius will operate out of the Chicago sales headquarters of the Meissner Division and will cover the middle western area.

### Minimum "Absorption" Pledged by Hotpoint

The "same as 1942" characterize Hotpoint range prices to consumers across the nation, including transportation and federal tax, as approved by the OPA, according to Gregory L. Rees, manager, range sales division, Edison General Electric Appliance Co.

Rees also said that final prices to distributors had not been issued as yet, but that Hotpoint is following a pricing policy aimed at price protection for the consumer with a minimum of "absorption" by dealers and distributors.

The deluxe "Masterpiece" RC 8 with timer oven control clock and seven quart "thrifty" cooker will deliver to consumers at \$244.50; the "middle-priced" Hostess RB 17 with automatic timer control will sell for \$177.75; while the lowest cost Century, RB 15, also a full size range, will cost users \$116.95.

### Brotherson Transferred

National Union Radio Corp. announces the transfer of Robert M. Brotherson to the following territory, as district manager:—The states of Mich. and Ky.; southern Ind., including Indianapolis; and Ohio, except Mahoning, Columbiana, Jefferson and Trumbull counties.

**LEAR**  
moves to  
a famous  
address  
in Chicago  
January 1st



The first of the year sees Lear Home Radio Sales Division set up headquarters in Chicago's Furniture Mart.

Here in these new quarters of ours you'll be able to see the new Lear Radios, the Lear Wire Recorder, the new and exclusive means of convenient tuning, and all the other features being made ready.

It's the place to shake hands with Nate Hast, Manager, and hear about the advantages that lie in the Lear Franchise.

Whenever you can, be sure to drop in and say "Hello."

#### LEAR, Incorporated

Home Radio Sales and Merchandising Division, Nate Hast—Merchandise Manager  
FURNITURE MART, SPACE 1730 B & C, CHICAGO 11, ILL.  
Until January 1st: Home Radio Sales Division,  
230 E. Ohio St., Chicago 11, Ill.

**LEAR RADIO**

# Just Published!

"A BOOK THAT SHOULD BE ON THE DESK OF EVERY RADIO EXECUTIVE"

## THE FIRST OFFICIAL RADIO & ELECTRONIC BUYERS' GUIDE

A COMPREHENSIVE PUBLICATION OF OVER 100 PAGES CONTAINING MANY NEW FEATURES, INCLUDING:

- A List of Manufacturers of Radio and Electronic components with the names and addresses of their regional representatives.
- A Geographical List of Manufacturers' Representatives.
- A "Where to Buy It" section.

NO ADVERTISEMENTS — Issued purely as a service to the Radio Parts Industry and distributed gratis by

"THE REPRESENTATIVES" OF RADIO PARTS MANUFACTURERS, INC.

The members of this organization have an average of more than 12 years' experience in serving the needs of their customers.

Cooperative periodic interchange of ideas between members on non-competitive matters offers distinct advantages to principals and customers.

Sensitive to local conditions, members are in a position to advise on trends affecting design, engineering policy, etc.

They maintain their own organizations with trained personnel and are constantly on call.

Get your free copy from any member of "The Representatives" or write direct to the Secretary.



DAVID SONKIN  
National Secretary  
347 FIFTH AVE.  
NEW YORK 16  
NEW YORK

### Merchandising Policy of Proctor Electric Issued

The Proctor Electric Co., Philadelphia, Pa., has issued a statement of merchandising policy which R. M. Oliver, vice-president, says, "We consider an integral part of our planning . . . and perhaps its most important part."

On distribution policies, the statement declares, "Proctor products will be sold only through recognized wholesalers duly franchised by us. To implement this policy, direct sales to tea and coffee companies, canvassers, cooperatives, department stores, and other outlets of this type have been discontinued.

"Also, production by the firm of private brand appliances has been halted. Thus the entire capacity of Proctor is made available to its recognized distributors. The sale of goods to wholesalers will be on a limited, but not exclusive basis."

The statement stresses the all-important job of cooperating with the jobber in training retail sales people, and adds, "We encourage distributors to handle non-competitive merchandise to round out their lines, and in some cases to handle items directly competitive with Proctor—provided that Proctor is given a fair apportionment of the jobber's salesman's time.

"In announcing new models," the statement continued, "the firm will follow a policy of giving wholesalers advance notice of model changes so that they and retailers can clear their stocks of merchandise that might otherwise become obsolete and require mark-downs.

"We plan shortly to have at least one competent service station in every major marketing area in the nation, independently owned and operated, but equipped and ready to give prompt repair service to Proctor appliance owners and dealers, with or without the factory guarantee."

### Garod Bond Buyers

Employees of the Garod Radio Corp., Brooklyn, N. Y., have again subscribed 100% to the Victory Loan, according to an announcement from Max Weintraub, president.

### Radio Parts Group Meets

The Radio Parts Industry Coordinating Committee, held its first New York meeting recently. The committee consists of the following sponsoring groups: NEDA, Parts Division of RMA, Electronic Parts and Equipment Manufacturers, and the Sales Managers Club. Discussed were the problems of surplus material, industrial sales, a show corporation to be called the Radio Parts and Electronic Equipment Shows, Inc., standard catalog sheets, standard packaging, and amateur radio.

### Emerson Sono-Buoy

The Sono-buoy an electronic device instrumental in whipping the Nazi submarine menace, and equally effective against the Japs, was produced by the Emerson Radio and Phonograph Corp., New York, in cooperation with the Navy, it has been made public.

AMCON

AN AMERICAN SOLUTION TO  
YOUR CAPACITOR PROBLEMS

ALL TYPES - BY-PASS  
AND ELECTROLYTIC

DATA SHEETS  
ON REQUEST

AMERICAN CONDENSER CO.  
4410 No. Ravenswood Ave. • Chicago 40, Ill.

Coming in March

# TWO BIG DIRECTORIES

in a single issue

All the information you need in directory form will come to you in the March issue of RADIO & Television RETAILING in two big compilations:

**the annual RADIO TRADE DIRECTORY  
and the new "ELECTRICAL APPLIANCES" DIRECTORY**

New manufacturers, new merchandise, accessories, parts, servicing equipment—new FM and television stations—where to buy appliances, etc. — the kind of material RADIO & Television RETAILING has been sending your way for twenty years. Now, together with the "ELECTRICAL APPLIANCES" DIRECTORY, published as part of our magazine-within-a-magazine, advertisers will have the benefit of double usage at a single cost. The 27,000 guaranteed circulation of RADIO & Television RETAILING gives these directories the largest distribution of any in the radio-electrical industry.

*Make Advertising Reservations NOW!*

**CALDWELL-CLEMENTS, Inc.** 480 LEXINGTON AVE., NEW YORK 17, PLaza 3-1340



## First Choice

### ... OF AMERICA'S AUTO DEALERS

The same precision workmanship and the same fine quality mark Ward Antennas now as before the war. But now there are added reasons of new design and newly-engineered efficiency which will give Ward Antennas an even greater margin of preference with America's auto dealers. For extra profits that satisfied customers always bring, order Ward—world's finest antennas for car and home.

Buy Victory Bonds  
**THE WARD PRODUCTS CORPORATION**  
1523 E. 45th St., Cleveland 3

# WARD

Antennas

## Electricity

Models range from 350 to 35,000 watts. A. C. types from 115 to 600 volts, 50, 60, 100 cycles, single or three-phase and 400, 500 and 800 cycles, single phase. D. C. types from 6 to 4000 volts. Also available in dual voltage and special frequency types.



### FOR RADIO AND ELECTRONIC APPLICATIONS

• **ONAN ELECTRIC GENERATING PLANTS** supply reliable, economical electrical service for electronics and television applications as well as for scores of general uses.

Driven by Onan-built, 4-cycle gasoline engines, these power units are of single-unit, compact design and sturdy construction. Suitable for mobile, stationary or emergency service.

Model shown is from WBC series; 2,000 to 3,500 watts; powered by Onan-built, two-cylinder, water-cooled engine.

**D. W. ONAN & SONS**

2038 Royalston Ave.  
Minneapolis 5, Minn.

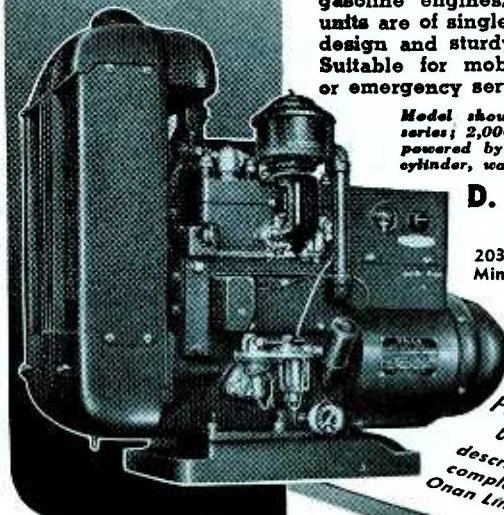

Write For Folder 630-A describing complete Onan Line

# AMPLICALL

## manufactures TIME!

Rauland AMPLICALL Paging and Two-Way Communications Systems actually manufacture time for businesses by enabling them to get much more productive effort each day from their present personnel. Thousands of small and large firms all over the nation place a high value on the multiple uses, flexibility and clear-cut tonal quality of their AMPLICALL equipment. They know, too, its great day-in-and-day-out performance record . . . and low cost of operation. Rauland national advertising, also, is keeping AMPLICALL constantly before business executives everywhere.



W200 Series AMPLICALL Intercommunication unit with facilities for up to 24 master stations and up to 12 possible conversations simultaneously

*Electron engineering is our business*

RADIO • RADAR  
SOUND

# Rauland

COMMUNICATIONS  
TELEVISION

THE RAULAND CORPORATION • CHICAGO 41, ILLINOIS

# RADIO

PRODUCTION  
and REPRODUCTION

*will be better because of*

## MONARCH

MEASURING • TESTING • CALIBRATING

## EQUIPMENT



2014 N. MAJOR AVE. • CHICAGO 39, ILL.

### **Freed Issues Booklet**

The Freed Radio Corp., New York City, has issued an attractive booklet, for dealer distribution, entitled "Expect Great Things from Freed-Eisemann." The booklet tells of Freed history, specializations, quality, cabinet designs, and future plans.

### **Balsam With Aerovox**

The appointment of George Balsam as advertising manager and director of sales promotion is announced by Aerovox Corp., New Bedford, Mass. He succeeds Paul L. Kuch who resigned in order to enter his own advertising business.

### **Gibson Sales Official**

F. E. Basler, vice-president in charge of sales, Gibson Refrigerator Co., announced the appointment of William H. Dennison as divisional sales manager of Gibson territory, which includes Arkansas, Oklahoma, New Mexico, Texas, Louisiana and the southern half of Mississippi.

## 20 Years Ago

*From the December, 1925, Issue  
of Radio Retailing*

"IT'S A MERRY CHRISTMAS, MR. RADIO MAN! AND HERE'S WHY"—Future prospects look good, radio's position grows stronger season by season, and "Business will come to the man who goes after it."

BROADCASTING BOOSTED SALES—Alabama Radio Dealer Builds His Own Transmitting Station and Supplies Programs in Barren Territory—Says Broadcasting Can Be Made a Profitable Feature.

BRINGING WOMEN INTO THE STORE—Dealer Pays Club Treasury Fifty Cents for Every Member Who Attends His Radio Concerts.

"SELLING BRINGS IN THE CUSTOMERS BUT SERVICE BRINGS THEM BACK"—Headline.

"WHAT'S NEW"—A radio clock that shows the correct time in all the time zones throughout the world; an aerial window lead-in designed so the windows may be closed tightly; a crystal radio receiver equipped with permanent detector.



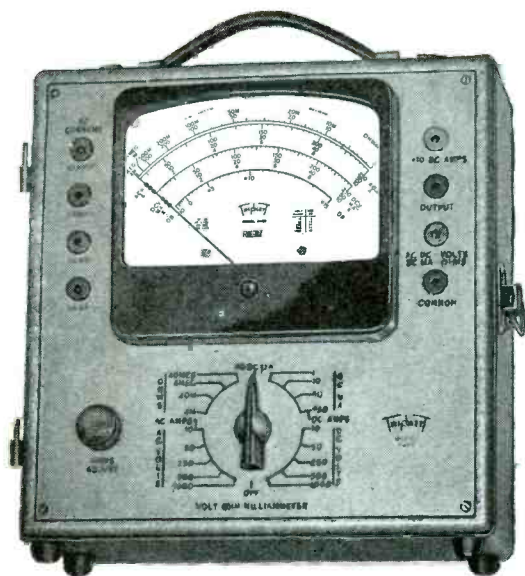

## MODEL 2405 Volt-Ohm-Milliammeter

25,000 OHMS PER VOLT D.C.



### SPECIFICATIONS

NEW "SQUARE LINE" metal case, attractive tan "hammered" baked-on enamel, brown trim.

■ **PLUG-IN RECTIFIER**—replacement in case of overloading is as simple as changing radio tube.

■ **READABILITY**—the most readable of all Volt-Ohm-Milliammeter scales—5.6 inches long at top arc.

■ **RED-DOT LIFETIME GUARANTEE** on 6" instrument protects against defects in workmanship and material.

### NEW ENGINEERING • NEW DESIGN • NEW RANGES 30 RANGES

Voltage: 5 D.C. 0-10-50-250-500-1000 at 25000 ohms per volt.

5 A.C. 0-10-50-250-500-1000 at 1000 ohms per volt.

Current: 4 A.C. 0-.5-1-5-10 amp.

6 D.C. 0-50 microamperes—0-1-10-50-250 milliamperes—0-10 amperes.

4 Resistance 0-4000-40,000 ohms—4-40 megohms.

6 Decibel -10 to +15, +29, +43, +49, +55

Output Condenser in series with A.C. volt ranges.

*Model 2400 is similar but has D.C. volts Ranges at 5000 ohms per volt.*

Write for complete description

# Triplet

ELECTRICAL INSTRUMENT CO.

BLUFFTON OHIO.

## AUTO ANTENNAS Designed for LEADERSHIP



Leaders in the auto antenna field for over a decade, JFD offers for prompt shipment auto antennas with these advantages:

1. Seamless Admiralty Brass Tubing
2. High-Polished Chromium Plating
3. Stainless Steel "Snap Back" Top Rod
4. Heavily Insulated Shielded Loom Lead
5. 100% Low Loss Construction

Eight Fast Selling Sizes and Types



Write for FREE literature #344

J. F. D. Manufacturing Co.  
4111 Ft. Hamilton Parkway,  
Brooklyn 19, N. Y.

"Columbia" is a reliable source

IMMEDIATE DELIVERY  
from STOCK!

### PLASTIC PARALLEL RIP CORD

2 CONDUCTOR—No. 18 Ga. Stranded

Easy to strip—easy to separate. The finest obtainable for radios, lamps, appliances, etc. Approximately 3000 ft. on reel.  
Per 1000 ft. ....\$14.95

OR  
250 ft. Metal Spools. Per 100 ft. ....\$1.65

### INSULATED ELECTRICAL WIRE

Gauges #22 to #4

Available for immediate delivery from stock in single and multi-conductors.

### 8 CONDUCTOR CABLE

2 conductors—#14 Ga. 6 conductors—#20 Ga.

Tinned copper stranded wire, varnished, cambric wrap-over color-coded conductors, tinned copper shield, live buna jacket.  
Per 1000 ft. ....\$34.50

**SPECIAL NOTICE!** Solid and stranded push-back wire in stock, #22 and #20 Ga. Write for samples and prices.

### 2 CONDUCTOR TWISTED WIRE

Made of 2 conductors #20 solid tinned copper, insulation is vinylite with glass-braid overall, high dielectric lacquer finish.  
Per 1000 ft. ....\$8.25

Write for Complete Circular No. 6D

ORDER FROM YOUR JOBBER or write direct

## COLUMBIA WIRE & SUPPLY CO.

4104 N. PULASKI RD., CHICAGO 41, ILLINOIS

# OHMITE RESISTORS

+  
*Your Guide to*  
**DEPENDABLE RESISTANCE CONTROL**  
+

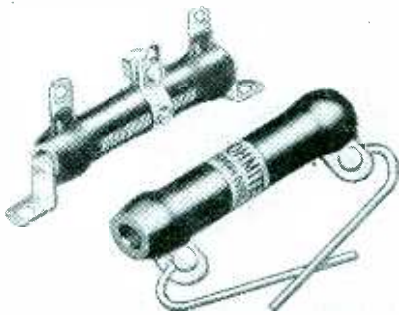

The service-record of Ohmite Brown Devil and Dividohm Resistors before and during the war . . . is your best guide to resistance-control now. Ohmite construction insures long, trouble-free performance . . . makes these units favorites for the best in resistor replacement.

Write for Stock Unit Catalog No. 18

Authorized Distributors Everywhere

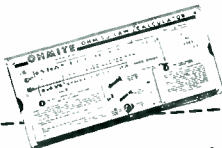

## OHM'S LAW CALCULATOR

Figures ohms, watts, volts, amperes . . . easily. Solves any Ohm's Law problem with one setting of the slide. Send only 10c in coin.

**OHMITE MANUFACTURING CO.**  
4871 FLOURNOY ST. • CHICAGO 44, U. S. A.

*Be Right with* **OHMITE**  
ARRESTERS • RESISTORS • TAP SWITCHES

## Jobber Appointments

AUDIO INDUSTRIES, Michigan City, Ind., manufacturers of Ultratone phonographs, announce the appointment of the following distributors: • Gross Distributors, Inc., New York 22, N. Y. • Henry O. Berman Co., Baltimore 2, Md. • H. & S. Distributing Co., Philadelphia 30, Pa. • Empire State Distributors, Albany 7, N. Y. • Hannon Automotive Corp., Rochester 4, N. Y. • H. D. Taylor Co., Buffalo 5, N. Y. • E. Stanley Freeman, Inc., Boston 10, Mass. • I. and M. Sufrin, Pittsburgh 3, Pa. • Grossman Music Co., Cleveland 15, Ohio • General Utilities Dists., Inc., Chicago 11, Ill. • Appliance Distributors, Inc., Indianapolis 4, Ind. • Bowers Wholesale Corp., Norfolk 1, Va. • General Utilities Corp., Milwaukee 4, Wis. • Gulf Appliance Distributors, Tampa 2, Florida.

PELCO, Bloomington, Ill., announces the following Freez-All home freezer distributorships: • James-Stevens Co. Albany, Ga. • Graybar Electric Co. branch, Asheville, N. C. • Associated Distributing Co., Atlanta, Ga. • Maine Industries, Bangor, Me. • Kelley-How-Thomson Co. branch, Billings, Mont. • Graybar Electric Co., Boston, Mass. • Foster Supply Co., Buffalo, N. Y. • Graybar Electric Co., Charlotte, N. C. • Bryant & Trimble Co., Chattanooga, Tenn. • Waken & Whipple, Inc., Chicago, Ill. • Perchan & Co. Cleveland, Ohio • Associated Distributing Co., Columbia, S. C. • Smith-Perry Electric Co., Dallas, Texas • Robert F. Clark Co., Denver, Colo. • Kelley-How-Thomson Co., Duluth, Minn. • Graybar Electric Co. branch, Durham, N. C. • Wise Radio Supply Co., Fort Smith, Ark. • Schlatter Hardware Co., Ft. Wayne, Ind. • The Mart, Inc., Ft. Worth, Texas • Edwin Flato Co., Houston, Texas • Associated Distributors, Indianapolis, Inc. • United Distributors branch, Jackson, Miss. • Florida Radio & Appliance Corp. branch, Jacksonville, Fla. • Bryant & Trimble Co., Knoxville, Tenn. • Korsemyer Co., Lincoln, Neb. • Kentworth Corp., Louisville, Ky. • Associated Distributors, Madison, Wis. • Graybar Electric Co. branch, Manchester, N. H. • Wayne Spinks Co., Inc., Memphis, Tenn. • Florida Radio & Appliance Corp., Miami, Fla. • Wayne Spinks Co., Inc., Nashville, Tenn. • United Distributors, New Orleans, La. • Graybar Electric Co. branch, Norfolk, Va. • Rye Auto Supply Co., North Little Rock, Ark. • Superior Distributing Co., Oklahoma City, Okla. • Lewis Bear Co., Inc., Pensacola, Fla. • Isaac Walker Hardware Co., Peoria, Ill. • Radio Specialties Co., Phoenix, Ariz. • Graybar Electric Co., Richmond, Va. • Graybar Electric Co. branch, Roanoke, Va. • Interstate Supply Co., St. Louis, Mo. • Kelley-How-Thomson Co. branch, St. Paul, Minn. • Alamon Distributing Co. branch, San Antonio, Texas • Harry C. Glou Co., Scranton, Pa. • Cloud Bros., South Bend, Ind. • Graybar Electric Co. branch, Springfield, Mass.

# LAKE'S

## RADIO CABINETS & PARTS

for  
**Your Every Need!**



Portable Phonograph case in brown leatherette covering. Inside dimensions 17 1/2" long, 13" wide, 7 1/2" high. Has blank motor board and opening for speaker. As illustrated at left, specially priced at . . .

**\$7.95**



Portable Phonograph case, of sturdy durable plywood, in handsome brown leatherette finish. Inside dimensions 16 1/2" long, 14" wide, 9 1/2" high. Has blank motor board. As illustrated above, specially priced at . . .

**\$6.95**

Also blank table cabinets of walnut veneer in the following sizes, with speaker opening on left front side: (\*Note: \*7 has center speaker grill)

\$1	— 8 1/4"	L x 5 1/4"	H x 4"	D \$1.95
\$2	— 10 1/4"	L x 6 1/4"	H x 3"	D \$2.75
\$3	— 13 1/4"	L x 7 1/4"	H x 6 1/4"	D \$3.25
\$7*	— 10 1/4"	L x 7"	H x 5 1/2"	D \$2.50
\$8	— 17"	L x 9"	H x 9 1/4"	D \$4.50
\$9	— 21"	L x 9 1/4"	H x 10 1/2"	D \$5.50

\*Speaker Opening in center of front side. Cabinets available in Ivory color and Swedish Modern. Write for prices.

### POWER TRANSFORMERS

4, 5, or 6 Tube—6.3V at 2 amp.	<b>\$1.49</b>
50 Mill Power Transformer . . .	
7, 8, or 9 Tube—6.3V at 3 amp.	<b>\$1.89</b>
70 Mill Power Transformer . . .	

SOUND ACCESSORIES. Complete line of amplifiers, microphones, speakers and sound accessories.

All types of radio cabinets and parts are available at Lake's Lower prices. A large stock is listed in our catalog.



**SERVICEMEN—RETAILERS**  
Join our customer list today.  
**Dept. B**

Write for our NEW 12 page, illustrated, elaborate catalog!  
**Order from Lake!**  
**You'll make no mistake!**

**Lake Radio Sales Co.**  
615 W. Randolph Street  
Chicago 6, Ill.

**AUTOMOBILES** ↗  
**HOMES** ↗  
**BOATS** ↗  
**HANDY TALKIES** ↗

# ANTENNAS



**SNYDER**  
 MANUFACTURING CO.  
 PHILADELPHIA 40, U.S.A.

**MANUFACTURERS START TO FINISH**

**Electro**  
 ELECTRICAL AND RADIO EQUIPMENT

## BATTERY ELIMINATORS



**Announcing!** Our New Models P and Q. They include every achievement of wartime ingenuity and lift battery radio reception to new heights of satisfaction. Cost but a few cents per hundred hours of operation. Sturdily constructed—no liquids or moving parts—operate in any position. Completely filtered, hum free, and silent in operation. Universal plugs and sockets to fit any radio.

**MODEL P**—For use in any place where normal AC is available. Operates any 1.4 volt—4, 5 or 6 tube battery radio from 115 v. 60 cy. source.

**MODEL Q**—For use wherever AC lines are not available—Farms, cottages, camps, or in car, motorboat, etc. Operates any 1.4 volt—4, 5 or 6 tube radio from 6 volt DC source.

**NOTE:** Due to critical material shortages at this time, our production is necessarily limited and deliveries can be made only through our present established jobbers. Canadian representative, Atlas Radio Corp., Toronto, Canada.

### ELECTRO PRODUCTS LABORATORIES

Pioneer Manufacturers of Battery Eliminators  
 549 WEST RANDOLPH STREET CHICAGO 6, ILL

Just the thing!



IT'S  
 A "NATURAL"  
 FOR CHRISTMAS

### The FM HOLLY GIFT BOX

An outstanding  
 Christmas  
 Promotion

A glittering Fidelitone Master  
 needle dressed in a brilliant open-  
 faced red-and-green holly gift box dis-  
 played on a beautiful, full-color,  
 14 inch Christmas tree easel stand.

It is smart... It's attrac-  
 tive... It will give months  
 of pleasure.

Truly a "natural" for Christ-  
 mas sales.

Gift boxes and Christmas tree  
 displays are available through  
 your Fidelitone distributor.



**Fidelitone  
 Master**  
 FLOATING POINT  
 PHOTOGRAPH NEEDLE



ATTRACTIVELY  
 PACKAGED  
 IN A USEFUL  
 RECORD BRUSH

**PERMO, INCORPORATED**  
 6413 RAVENSWOOD AVE., CHICAGO 26

# ROEHR DISTRIBUTING COMPANY

St. Louis' Radio  
Mail Order House

**TUBES  
TRANSFORMERS  
CONDENSERS  
RESISTORS  
SPEAKERS  
MIKES  
ANTENNAS, ETC.**

Distributors for  
**BELL SOUND EQUIPMENT  
and  
TEMPLE RADIOS**  
Write for our list of tubes  
**ST. LOUIS 3, MO.**



## 2,160-inch Spool of SCOTCH TAPE

A money-saving miracle! 2,160 inches of genuine Scotch Brand paper-backed electrical and radio tape, approx. 1/2" wide. Sticks to any dry surface. Insulates turns on transformers, coils, radio parts, etc. Perfect for attaching paper to glass or any flat or curved surface. Our price is way below the actual value! (This offer good only in U. S. A.)

ONLY  
**50¢**  
POSTPAID

MAIL  
THIS  
COUPON  
TODAY

SEND FOR OUR FREE  
BARGAIN BULLETINS!

**Olson Radio Warehouse**

73 E. MILL ST., DEPT. 5, AKRON, OHIO

Send me \_\_\_\_\_ 2,160-inch spools of Scotch Tape  
at 50¢ each, postpaid. I enclose \$ \_\_\_\_\_

NAME \_\_\_\_\_

ADDRESS \_\_\_\_\_

### Chicago Appliance Show

The 1946 Housewares and Major Appliance Exhibit and Sales Conference will be held in Chicago from Dec. 30 until Jan. 4. Displays of latest merchandise in electrical appliances and housewares will be shown.

### Baker Heads RCA Victor Home Instrument Div.

Appointment of Henry G. Baker, as general sales manager of the home instrument division of RCA Victor, has been announced by Joseph B. Elliott, general manager of the division. Prior to his present assignment, Mr. Baker had been general purchasing director for RCA Victor.

### Hotpoint Sales Officials

Don W. Rennewanz has been appointed sales manager of the range division, Edison General Electric (Hotpoint) Appliance Co., according to Gregory L. Rees, manager, range and water heater sales division.

Hotpoint also announced the appointments of H. L. Cushing as district sales manager, Dallas, Tex.; Harold B. Cromleigh, district sales manager, Philadelphia, Pa.; D. C. Risher, district sales manager, Charlotte, N. C.; and Samuel J. Houston, general representative for the eastern region with headquarters at the company's New York office.

### Ben Joseph Appointed

The appointment of Ben Joseph, 258 Broadway, New York, as eastern sales representative has been announced by the British Industries Sales Corp. of 401 Broadway, New York. This sales organization was recently formed by William Carduner to handle the sales throughout the United States of exclusively British products including Garrard Record Changers, Ersin Multicore Solder and Solon Soldering Irons.

### Aireon Stages Preview

Aireon Mfg. Corp., Kansas City, Kan., held a showing demonstrating things to come in the way of automatic phonographs. This preview offered music distributors a glimpse of advantages offered their field in the application of the science of electronics to record reproduction.

### Wisconsin Radio Men Meet

The executive committee of the Wisconsin Radio Refrigeration & Appliance Assn. voted unanimously to revive the association on a dues-paying basis as of January 1, 1946. An immediate start on the job of rebuilding the membership roster and of getting other re-organization work underway was pledged.

### Name E. W. Isenhower

Appointment of E. W. Isenhower as manager of the Southern California district of the Westinghouse home radio division, with headquarters in Los Angeles, is announced by Harold B. Donley, manager of the division, Sunbury, Pa.

## POST-WAR Special



### 6 TUBE "SUPER HET" RADIO KIT

Complete, including Attractive Walnut Cabinet Diagram Furnished. Uses 6SA7-6SQ7-6SJ7-6SK7-25L6-25Z6.

### ALL PARTS MOUNTED

To assemble, all one needs is a soldering iron and 30 minutes of your time.

**\$16<sup>95</sup>** LESS  
TUBES

Limited Quantity on Hand

TERMS: 10% DEPOSIT WITH ORDER—BALANCE C. O. D.

**LIBERTY SALES CO., INC.**  
115 WEST BROADWAY · NEW YORK 13, N. Y.

## IMMEDIATE DELIVERY! Signal Corps TELEGRAPH KEY



Genuine U. S. Signal Corps key with switch to close contacts, polished durable enameled metal base mounted on a bakelite base, key lever is nickel-plated, brass-silver contacts; packed in new, original boxes. Shipping weight, 1 lb. 10 for \$11.00 **\$1.29 ea.**

## Army-Navy Type HEADPHONES

Type HS-33



Save up to 70% on genuine U. S. Signal Corps headphones. These are the better \$10.00 headphones for only \$2.95. Leather-covered headband, detachable rubber cushions, lightweight construction, impedance 8000 ohms. Ea. . . . . **\$2.95**

Order from your jobber or write direct.  
Write for our illustrated literature  
featuring all types of radio parts.

Dept. B.

**ARROW RADIO CO.**  
2205 W. Division St., Chicago 22, Ill.

# INDEX To Advertisers

DECEMBER, 1945

	Page		Page
Admiral Corp. ....	2, 3	Marion Electrical Instrument Co. ....	25
Aerovox Corp. ....	141	Meissner Mfg. Co. ....	18
Alliance Mfg. Co. ....	134	Merit Coil & Transformer Corp. ....	4
American Condenser Co. ....	156	Monarch Mfg. Co. ....	158
American Phenolic Corp. ....	107	Muter Co. ....	142
Ansley Radio Corp. ....	23		
Arrow Radio Co. ....	162	National Union Radio Corp. ....	13
Astatic Corp. ....	102	Newcomb Audio Products Co. ....	164
Audio Industries ....	9	Noblitt-Sparks Industries, Inc. ....	109
Automatic Radio Mfg. Co. ....	99		
		Ohmite Mfg. Co. ....	160
Bell Sound Systems, Inc. ....	148	Olson Radio Warehouse ....	162
Belmont Radio Supply ....	138	Onan & Sons, D. W. ....	157
Bendix Radio Div., Bendix Aviation Corp. ....	8		
Burgess Battery Co. ....	118	Permo, Inc. ....	161
Burstein-Applebee Co. ....	106	Philco Corp. ....	15
		Pilot Radio Corp. ....	154
Caldwell-Clements, Inc. ....	149, 157	Presto Recording Corp. ....	6
Centralab ....	139		
Chicago Tribune ....	26	Quam-Nichols Co. ....	163
Cinaudagraph Speakers, Inc. ....	145		
Ciarostat Mfg. Co., Inc. ....	132	Radiart Corp. ....	95
Columbia Wire & Supply Co. ....	159	Radio Corp. of America:	
Commercial Credit Co. ....	74	RCA Victor Div. ....	82, 83, 84
Crosley Corp. ....	75	Tube Div. ....	81, 111
		Radio Supply & Engineering Co., Inc. ....	140
Decca Distributing Corp. ....	55	Rauland Corp. ....	158
Delco Radio Div. of General Motors ....	17	Ray-O-Vac Co. ....	137
DuMont Laboratories, Inc., Allen B. ....	121	Raytheon Mfg. Co. ....	20, 21
		Representatives of Radio Parts Manufacturers, Inc. ....	156
Eastern Amplifier Corp. ....	19	Roehr Distributing Co. ....	162
Electro Products Laboratories ....	161		
Electronic Laboratories, Inc. ....	147	Seeburg Corp., J. P. ....	Cover 3
Emerson Radio & Phonograph Corp. ....	31	Simpson Mfg. Co., Mark ....	106
Estate Stove Co. ....	68	Snyder Mfg. Co. ....	161
		Sonora Radio & Television Corp. ....	123
Fada Radio & Electric Co. ....	29	Sound Equipment Corp. of California ....	124
Fawcett Publications, Inc. ....	30	Sparks-Withington Co. ....	12
		Sprague Products Co. ....	28, 151
Galvin Mfg. Corp. ....	Cover 4	Standard Transformer Corp. ....	148
Garod Radio Corp. ....	5	Sterling Mfg. Co. ....	143
General Electric Co. ....	27, 116	Stewart-Warner Corp. ....	119
General Industries Co. ....	144	Stromberg-Carlson Co. ....	32
General Transformer Corp. ....	129	Superior Instruments Co. ....	11
Graybar Electric Co. ....	69	Supreme Instruments Corp. ....	144
		Sylvania Electric Products, Inc. ....	14
Hallicrafters Co. ....	91		
Hamilton Radio Corp. ....	103	Talk-A-Phone Mfg. Co. ....	150
Hammarlund Mfg. Co., Inc. ....	135	Templetone Radio Mfg. Corp. ....	125
Howard Radio Co. ....	127	Trilmont Products Co. ....	77
Hytron Radio & Electronics Corp. ....	113	Triplett Electrical Instrument Co. ....	159
		True Confessions ....	93
International Resistance Co. ....	115	Tung-Sol Lamp Works, Inc. ....	22
		Turner Co. ....	98
Jackson Electrical Instrument Co. ....	94		
Jensen Radio Mfg. Co. ....	10	U. S. Electric Mfg. Corp. ....	130
J. F. D. Mfg. Co. ....	159		
		Vokar Corp. ....	146
Ken-Rad Div. of General Electric Co. ....	7	Ward Leonard Electric Co. ....	150
Keystone Electronics Co. ....	154	Ward Products Corp. ....	157
		Waters Conley Co. ....	126
Lake Radio Sales Co. ....	160	Webster Electric Co. ....	86
Lear, Inc. ....	24, 155	Weller Mfg. Co. ....	146
Liberty Sales Co., Inc. ....	162	Weston Electrical Industrial Corp. ....	152
		White Organization, Bob ....	68
Maguire Industries, Inc., Thordarson Div. ....	87	Wholesale Radio Laboratories ....	136
Mahogany Association, Inc. ....	131	Wilcox-Gay Corp. ....	153
Majestic Radio & Television Corp. ....	133	Wittie Mfg. & Sales Co. ....	62
Mallory & Co., Inc., P. R. ....	Cover 2, 16		

While every precaution is taken to insure accuracy, we cannot guarantee against the possibility of an occasional change or omission in the preparation of this Index.

# QUAM

*extends  
speaker life  
with*

*Adjust-a-Cone*



**Makes it possible  
to correct a rubbing  
voice coil . . .  
easily . . . quickly!**

NOW . . . in Quam Speakers . . . the spider no longer is glued or otherwise permanently fastened to the basket. Instead it is held firmly in position by a spring clamping ring secured with two machine screws. Loosen the screws. The spider may be moved laterally. The voice coil thus can be re-centered around the pole piece and within the gap.

In many cases the adjustments are so placed that a rubbing voice coil may be corrected right in the home in a matter of minutes **without removing the speaker from the chassis.** QUAM ADJUST-A-CONE saves servicing time . . . saves new parts cost . . . actually extends speaker life.

For complete details write today to

**QUAM-NICHOLS CO.**

33rd Place at Cottage Grove,  
CHICAGO 16

# Now an entirely new line!

*Quality  
sound equipment  
by  
Newcomb*

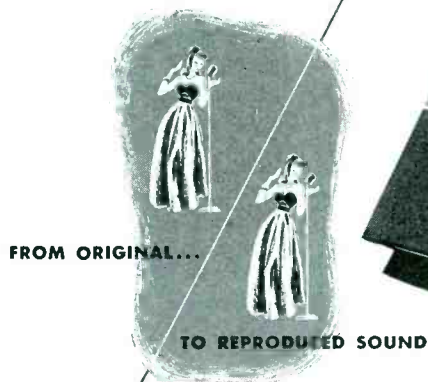

*The Line Between is mighty thin*



**P**RESENTING our newest line of amplifiers . . . they offer you greater excellence in sound reproduction than has ever before been available to the public address field. Designed and produced by an organization devoted exclusively, for more than seven years, to the perfection of fine

sound equipment, they embody all the practical benefits of today's most advanced electronic achievements.



Send for the catalog . . . compare Newcomb with others . . . you'll find no other amplifier has so many advantages.

T H E S O U N D O F Q U A L I T Y

*Newcomb*

**AUDIO PRODUCTS CO.**

MANUFACTURERS

DEPT. A. 2815 S. HILL STREET, LOS ANGELES 7, CALIFORNIA



**MINIMUM FRICTION  
LONG LIFE • SILENT  
CONSTANT SPEED**

# SEEBURG RECORD CHANGERS

The engineering features in SEEBURG RECORD CHANGERS are generally included in high priced professional transcription equipment.



## SEEBURG *Wire* RECORDER

The SEEBURG WIRE RECORDER is an electronic engineering achievement! One simple control knob operates the SEEBURG WIRE RECORDER to reproduce and record speeches, plays, meetings, music, radio programs, etc. No needles or discs are used.

IT WILL BE NECESSARY...  
for radio manufacturers to make provisions  
in their circuits to accommodate the SEEBURG  
WIRE RECORDER. We therefore invite prompt  
inquiries from interested radio manufacturers.

# Seeburg

J. P. SEEBURG CORPORATION • CHICAGO

**YOU**

# CARRY THE BALL... *Motorola* CLEARS THE WAY!

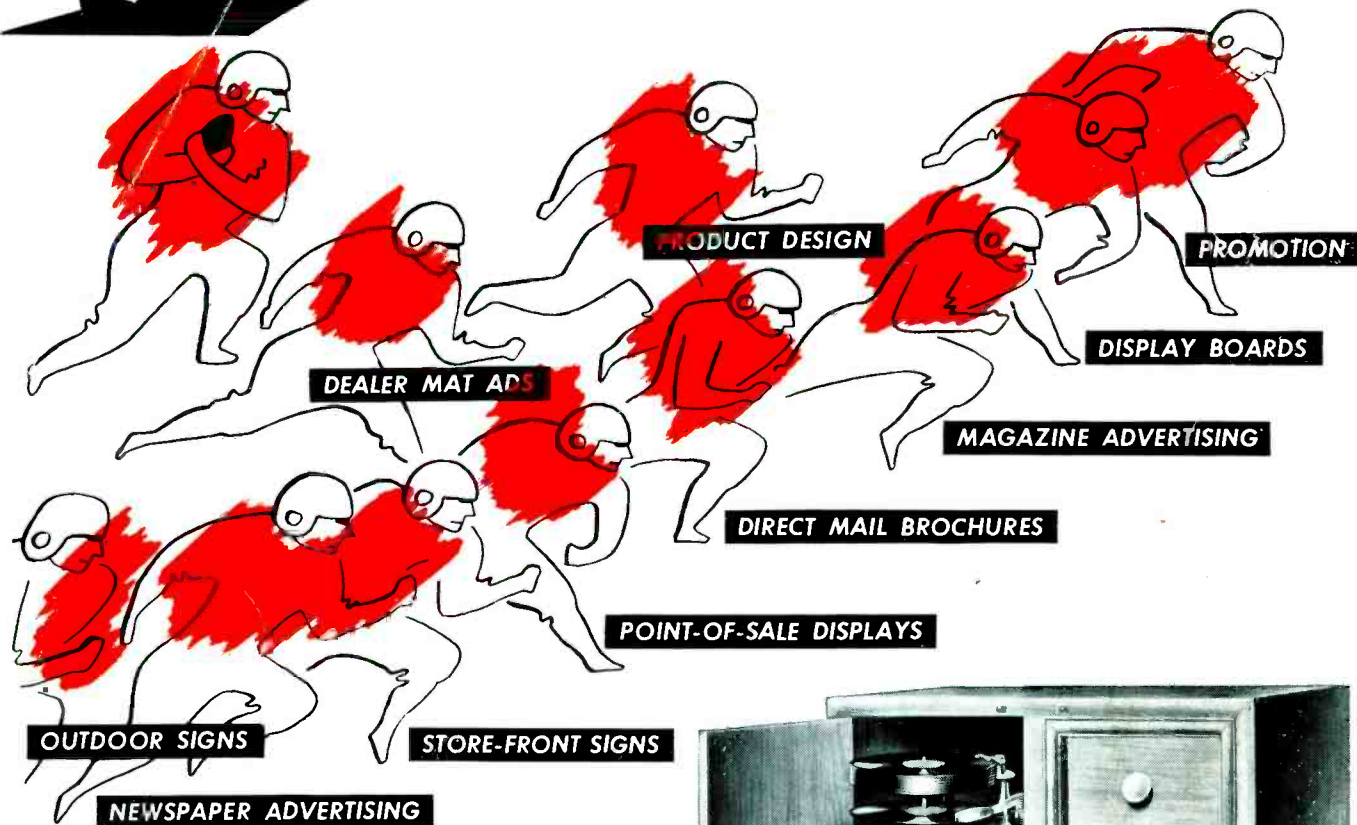

You, the dealer, are the ball carrier on our team. It is you who makes the sale of Motorola to your customers. And when you're on the Motorola team you can count on the kind of support that clears the way for you—straight to the cash register! Product design that gives each Motorola Radio the utmost in eye-appeal, National Advertising that reaches 38,000,000 families with each ad, the largest Outdoor Sign program in radio history, dealers helps, ad mats, special promotions are all working with co-ordinated teamwork to facilitate the easy sale of Motorola Radios.

GALVIN MFG. CORPORATION • CHICAGO 51



**AND YOU'RE SELLING THE  
FINEST RADIO MONEY CAN BUY!**

# *Motorola* **A-M F-M** *Radio*

F-M & A-M HOME RADIO • AUTO RADIO • AUTOMATIC PHONOGRAPHS • TELEVISION • AIRCRAFT RADIO • POLICE RADIO • RADAR